

PRINTED IN USA
P/N 990-30229

COPYRIGHT© 2016
BRODERSON MFG. CORP.

OPERATION AND MAINTENANCE MANUAL IC-35-2G

OWNER: _____

SOLD AND SERVICED BY: _____

MODEL NO. _____ SERIAL NO. _____

BRODERSON MANUFACTURING CORP.

STATEMENT OF WARRANTY FOR MOBILE CRANES

Broderson Manufacturing Corp. ("BMC") warrants its products to be free from defects in material or workmanship at the date of shipment from BMC. This warranty shall be effective only when validated by the return to BMC of its standard form of Warranty Validation Certificate (Attachment A), duly completed and signed by the original purchaser from BMC and any subsequent purchaser who buys a BMC product as a new product, and then only as to defects reported to BMC in writing within 1 year or 2000 hours, whichever occurs first, from the date a product is placed in service, as evidenced by such warranty validation certificate. **THIS WARRANTY APPLIES TO ALL PARTS OF BMC'S PRODUCTS EXCEPT ENGINES, DRIVE TRAINS, HYDRAULIC SYSTEM COMPONENTS, TIRES, OR ACCESSORY EQUIPMENT, WITH RESPECT TO WHICH BMC MAKES NO WARRANTY OF MERCHANTABILITY OR FITNESS FOR A PARTICULAR PURPOSE AND NO OTHER WARRANTY OF ANY KIND, EXPRESS OR IMPLIED;** the sole warranties, if any, with respect thereto being those made by the respective manufacturers thereof.

THE SOLE REMEDY FOR BREACH BY BMC OF THIS WARRANTY SHALL BE THE REPLACEMENT OF ANY PARTS OF ITS PRODUCTS WHICH WERE DEFECTIVE AT THE DATE OF SHIPMENT OR, IF (AND ONLY IF) REPLACEMENT OF DEFECTIVE PARTS IS IMPOSSIBLE OR IS DEEMED BY BMC TO BE IMPRACTICAL, REPLACEMENT OF THE ENTIRE PRODUCT OR, AT BMC'S OPTION, REFUND OF THE PURCHASE PRICE. The replacement remedies include labor in connection with the removal of defective parts and the installation of their replacements, as well as the cost of delivery and transportation of defective products or parts and the replacements thereof. The sole purpose of these remedies is to provide the purchaser with free replacement of defective parts or, in the limited circumstances specified, replacement of the entire product or a refund of the purchase price. These exclusive remedies shall not be deemed to have failed of their essential purpose so long as BMC is willing and able to replace defective parts or the entire product or to refund the purchase price. The remedies herein provided shall be available only if BMC is given reasonable access to the product, including all allegedly defective parts, promptly after the defect is discovered. BMC shall have the right to return any allegedly defective parts to its plant or any other location selected by it, for inspection and testing to determine whether they were defective at the date of shipment, prior to replacement thereof.

The warranty herein made is extended only to the original purchaser from BMC and any subsequent purchaser who buys a BMC product as a new product. **WITHOUT LIMITING THE GENERALITY OF THE FOREGOING, BMC EXPRESSLY DISCLAIMS THAT THE WARRANTY MADE HEREIN EXTENDS TO A PERSON WHO RENTS OR LEASES ANY BMC PRODUCT OR WHO PURCHASES ANY BMC PRODUCT AS A USED PRODUCT.** For purposes hereof, a BMC product shall conclusively be deemed "used" after the expiration of twelve (12) months from its placement in service, as evidenced by a duly completed and signed warranty validation certificate actually received by Broderson, or after such earlier time as it has been operated for more than one hundred (100) hours. This warranty shall not apply to ordinary wear and tear; negligence; acts of God; vandalism; abuse; misuse; neglect; accident or causes beyond the reasonable control of BMC, including without limitation fires, freezing, floods and other natural disasters; overloading; unauthorized altered, modified or changed products or parts; products or parts that have been improperly adjusted; or the Purchaser's neglect, negligence or willful damage; any products or parts not provided by BMC; any products or parts which have been repaired outside of BMC or an authorized distributor facility ; unless authorized in writing by BMC; or damages caused by failure to follow the maintenance procedures outlined in the applicable service manual or in technical bulletins issued by BMC.

BMC does not warrant any of its products to meet any state, local or municipal law, ordinance, code, rule or regulation. The purchaser must assume the responsibility for maintaining and operating the products which are the subject of this warranty in compliance with such of the foregoing as may be applicable, and BMC shall not be liable for the purchaser's failure to meet such responsibility.

THE WARRANTY HEREIN MADE IS IN LIEU OF ANY OTHER WARRANTY, EXPRESS OR IMPLIED. BMC MAKES NO WARRANTY OF MERCHANTABILITY OR FITNESS FOR A PARTICULAR PURPOSE, OR ANY OTHER EXPRESS OR IMPLIED WARRANTY OF ANY KIND, TO ANY PURCHASER, LESSEE OR RENTER OF NEW OR USED BMC PRODUCTS OR ANY OTHER PERSON WHATSOEVER. NO PERSON IS AUTHORIZED TO ACT ON BEHALF OF BMC IN MODIFYING THE WARRANTY HEREIN MADE OR IN MAKING ANY ADDITIONAL OR OTHER WARRANTY.

IN NO EVENT SHALL BMC BE LIABLE FOR INCIDENTAL OR CONSEQUENTIAL DAMAGES OF ANY KIND WHATSOEVER. THIS EXCLUSION OF INCIDENTAL AND CONSEQUENTIAL DAMAGES IS INTENDED TO BE INDEPENDENT OF ALL OTHER PROVISIONS OF THIS STATEMENT OF WARRANTY AND SHALL BE GIVEN FULL EFFECT NOTWITHSTANDING THE UNENFORCEABILITY OR FAILURE OF THE ESSENTIAL PURPOSE OF ANY OTHER PROVISION OF THIS STATEMENT OF WARRANTY.

THE FOREGOING DISCLAIMERS OF WARRANTIES AND DISCLAIMER OF LIABILITY FOR INCIDENTAL OR CONSEQUENTIAL DAMAGES SHALL BE EFFECTIVE REGARDLESS OF WHETHER THE EXPRESS WARRANTY CONTAINED HEREIN BECOMES EFFECTIVE AS PROVIDED IN THE FIRST PARAGRAPH HEREOF.

TABLE OF CONTENTS

SECTION 1	DESCRIPTION and SPECIFICATIONS	
	Introduction.....	1-1
	Dimensions and Orientation IC-35-2G.....	1-2
	Turning Dimensions.....	1-3
	Description and Specifications.....	1-4
SECTION 2	OPERATION	
	Safety Rules.....	2-1
	Instruments and Controls.....	2-5
	Control Functions.....	2-6
	Sequence of Operation.....	2-7
	Driving the Vehicle.....	2-7
	Operating the Crane.....	2-8
	Normal Gauge Readings.....	2-8
	Rated Capacity Limiter.....	2-9
	Crane Capacity.....	2-10
	Crane Capacity Example.....	2-12
	Crane Capacity Chart IC-35-2G.....	2-13
	Crane Capacity Chart IC-35-2G Metric.....	2-14
	Sheave Block and Downhaul.....	2-15
	Two-Part-Line Reeving.....	2-16
	Safety Devices.....	2-17
	Optional Equipment Operation.....	2-18
	Boom Extension.....	2-18
	Front Auxiliary Winch.....	2-19
	Switch and Indicator Symbols on BMC Cranes.....	2-20
SECTION 3	MAINTENANCE	
	Safety Rules.....	3-1
	Inspection and Testing Checklists.....	3-3
	Maintenance Checklist.....	3-5
	Lubrication.....	3-8
	Rotation Bearing.....	3-8
	Torque Hub Lubrication.....	3-8
	Wire Rope.....	3-8
	Lubrication Chart and Schedule.....	3-9
	Hoist Cable Installation and Inspection.....	3-11
	Hydraulic System Description.....	3-15
	JIC Schematic.....	3-13
	JIC Schematic Metric.....	3-14
	Steering System.....	3-15
	Propulsion System.....	3-17
	Hydraulic System Maintenance.....	3-19
	Transmission Start-Up Procedure.....	3-19
	Transmission Troubleshooting.....	3-21
	Care of Hydraulic Oil.....	3-22
	Hydraulic Oil Specifications.....	3-23

SECTION 3 MAINTENANCE (cont'd)

Hydraulic System Maintenance.....	3-19
Purging the Hydraulic System.....	3-23
Bleeding the Brakes.....	3-25
Hydraulic Seals.....	3-26
Hydraulic System Adjustments.....	3-27
Control Valves.....	3-27
Boom Cylinder Holding Valve.....	3-28
Extension Cylinder Holding Valve.....	3-28
Engine Maintenance.....	3-29
Air Cleaner Service.....	3-29
Cooling System.....	3-29
Spare Parts List.....	3-29
Major Engine Servicing.....	3-29
Mechanical Adjustments.....	3-30
Fasteners.....	3-30
Rotation Gearbox.....	3-30
Wheel Bearings.....	3-30
Wheel Alignment.....	3-30
Torque Data.....	3-31

BRODERSON MANUFACTURING CORP.

IC-35 INDUSTRIAL CRANE

INTRODUCTION

The Broderson IC-35 was designed and built to provide safe, dependable and efficient crane service. This we assure by our testing and quality control procedures. To properly utilize the full potential of the equipment, the following customer controlled conditions must exist:

1. The operator must understand the equipment.
2. The operator must know the operating characteristics.
3. The operator must observe the safety rules.
4. The equipment must be given proper maintenance.

This manual was written to provide information required for these conditions. The recommendations for periodic inspection, test and maintenance are minimum standards for safe and economical performance.

When ordering parts, the unit serial number, unit model number, part number, part description and quantity must be provided.

This unit must not be altered or modified without written factory approval.

To reorder this manual, ask for IC-35-2G Operation and Maintenance Manual Part Number 99030229. Contact your Broderson service representative at:

Broderson Manufacturing Corp.
14741 W. 106th Street
Lenexa, Kansas 66215 USA

913-888-0606

NOTICE

If this crane becomes involved in an accident, please call Broderson Manufacturing Corp. at 913-888-0606, and ask for the Legal Department or the Service Manager. Also, please notify your Broderson dealer.

DIMENSIONS AND ORIENTATION IC-35-2G

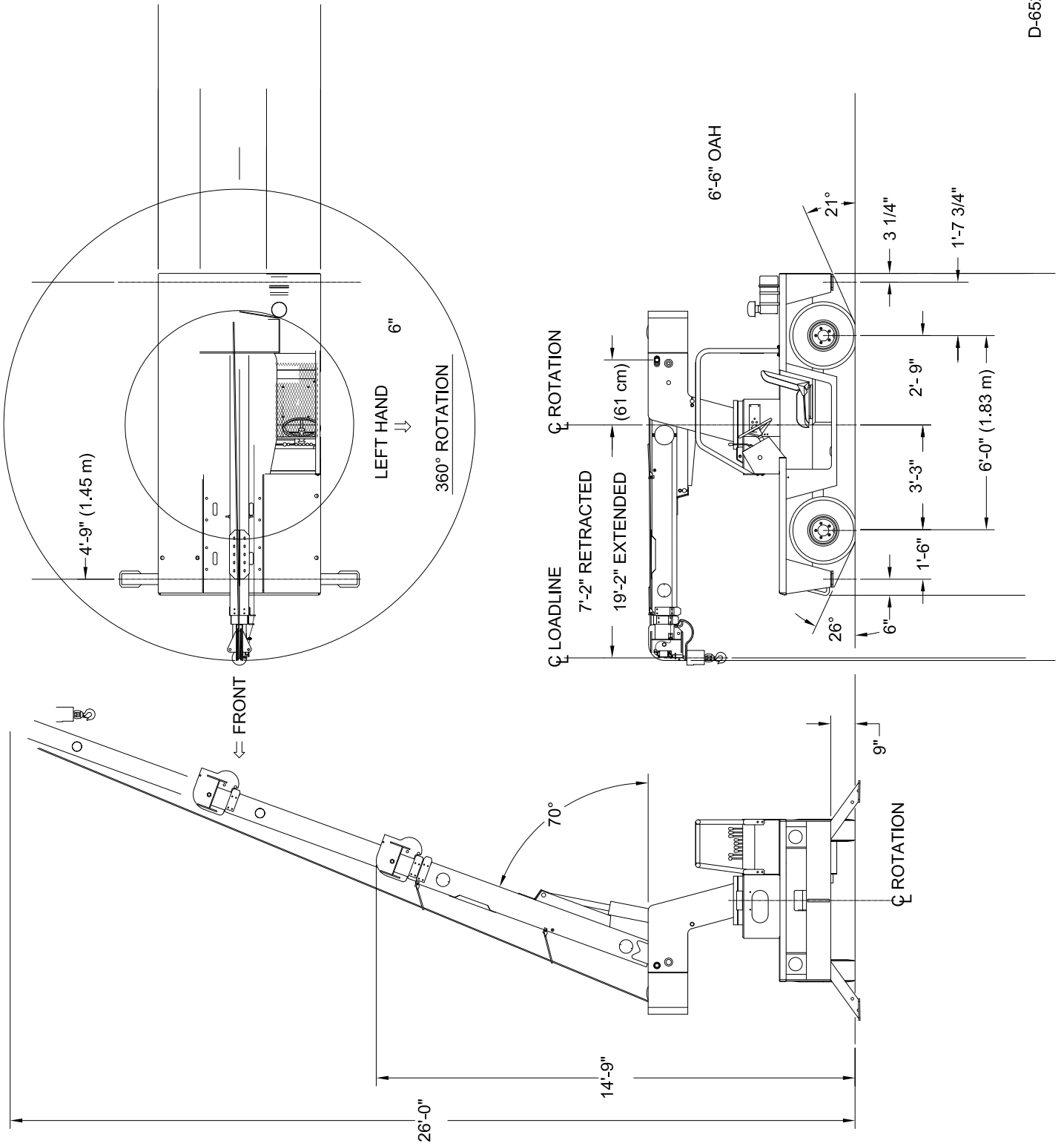

D-652-00751

TURNING DIMENSIONS

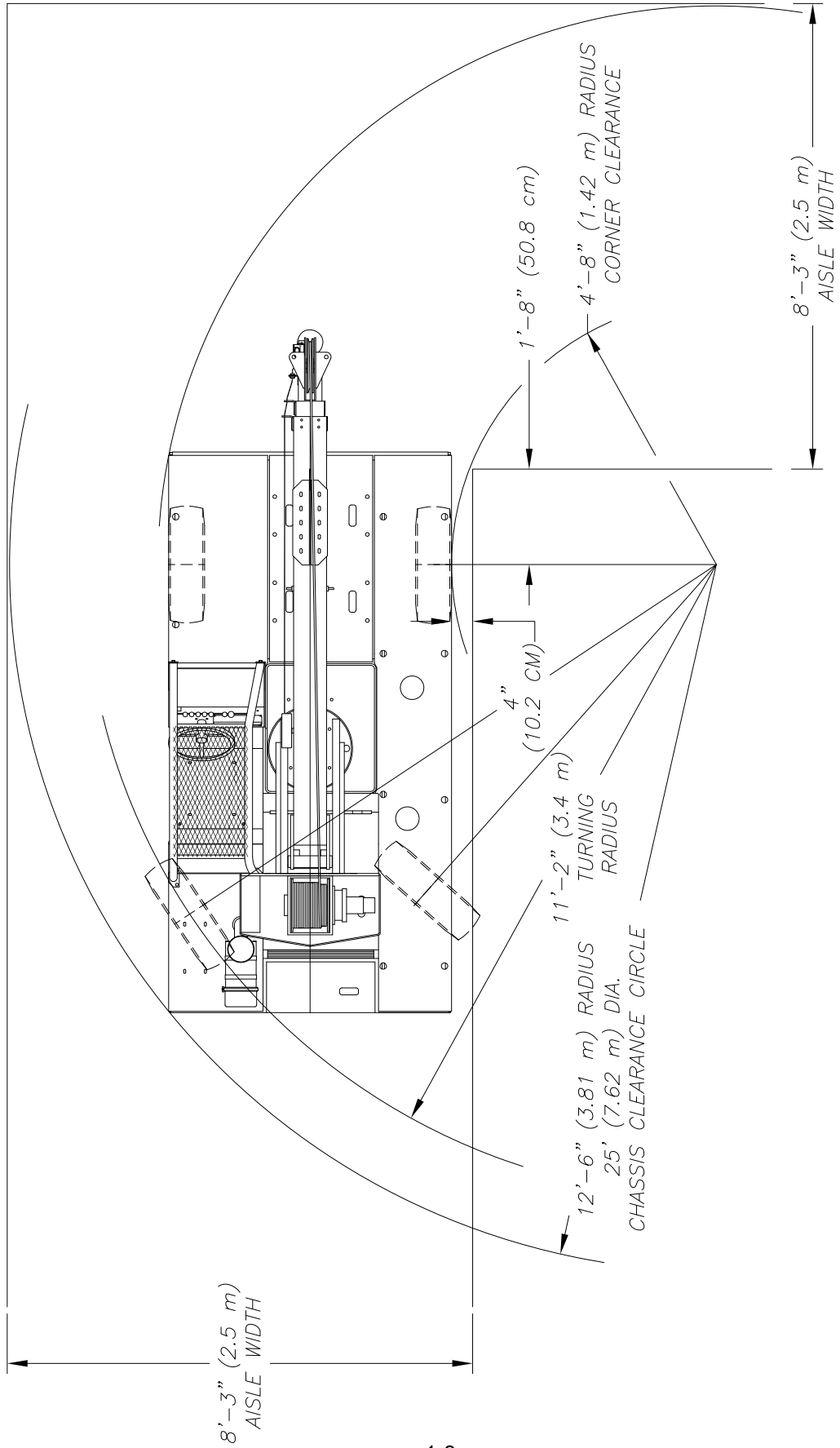

SECTION 1

DESCRIPTION AND SPECIFICATIONS

BMC's IC-35-2G is a self-propelled industrial crane designed for in-plant lifting and material handling applications. It has the special features of low height, narrow width, short length, cargo deck, rear wheel steer, and front wheel drive. The basic unit consists of a chassis and hydraulic boom assembly. The chassis includes a frame, four hydraulic outriggers, engine, variable speed hydrostatic transmission, front driving and rear power steering axles. The boom assembly includes a hydraulic powered continuous rotation turret, 3-section telescopic boom, hydraulic boom elevating cylinder, hydraulic boom extension cylinders and hydraulic powered hoist. A Rated Capacity Limiter is also standard.

IC-35-2G:

3-section hydraulically extended boom with capacity of 8,000 pounds (3629 kg) at a 4-foot (1.2 m) load radius. Horizontal reach of 19 feet 2 inches (5.84 m) and vertical reach of 26 feet (7.92 m). Hoist is located on back of turret.

GENERAL:

Length:	
Chassis	9 feet 11 inches (3.02 m)
Overall	11 feet 11 inches (3.63 m)
Width:	5 feet 0 inches (1.52 m)
Height:	
Deck	28 inches (71.12 cm)
Overall	6 feet 6 inches (1.98 m)
Wheelbase:	6 feet 0 inches (1.83 m)
Ground Clearance:	
Chassis	7 inches (17.78 cm)
Minimum (Rear Axle)	5 inches (12.7 cm)
Angle of Approach:	26 degrees
Angle of Departure:	21 degrees
Turning Radius: (Min.)	11 feet 2 inches (3.40 m)
Aisle Width: 90 degree Turn (Min.)	8 feet 3 inches (2.52 m)
Travel Speed: (Max.)	10 mph (16 km/h)

Weight Distribution:	
Front Axle	3780 pounds (1715 kg)
Rear Axle	4080 pounds (1850 kg)
Total	7860 pounds (3565 kg)
Tire Footprint Area:	46 square inches (297 cm ²), each
Outrigger Footprint Area:	48 square inches (310 cm ²), each
Drawbar Pull:	2120 pounds (960 kg)
Gradeability:	30% (1)
Grade Limit:	20%
Boom Movement:	
Rotation	Continuous
Elevation	70 degrees
Extension	12 feet (3.66 m)
Tail swing	3 feet 6 inches (1.07 m)
Boom Speeds:	
Rotation	360 degrees in 39 sec. (1.5 rpm)
Elevation	17 seconds
Extension	32 seconds
Sheave Height:	
Without Jib	26 feet 0 inches (7.92 m)
With Jib	33 feet 4 inches (10.16 m)
Horizontal Reach:	
Without Jib	19 feet 2 inches (5.84 m)
With Jib	27 feet 2 inches (8.28 m)

1) Calculated value based on Kubota WG1605 engine.

Engine:**Standard Gasoline:****Kubota 1.6 L, EFI Dual Fuel, EPA Tier 4 Final Certified:**

Kubota WG1605-GL-E3 gasoline engine complete with multi-port electronic fuel injection, dual fuel, and engine management system. Water-cooled, 4-cylinder, 94 CID (1.6 L), 3.11-inch (79 mm) bore, 3.09-inch (78.4 mm) stroke, 43.7 HP (32.6 kW) at governed speed of 2600 rpm. Maximum torque, 88.7 ft-lbs (120.2 Nm) at 2400 rpm. 70-amp alternator, 13.5-gallon (51 L) gas tank, and 33-lb (15 kg) LPG tank.

Optional Engines and Accessories:**Kubota 1.8 L, EPA Tier 4 Final Certified:**

Kubota D1803-CR-TIE4B diesel engine. Water-cooled, 3-cylinder, turbocharged and inter-cooled, 111 CID (1.8 L), 3.43-inch (87 mm) bore, 4.04-inch (102 mm) stroke. 49.6 HP (37.0 kW) at governed speed of 2700 rpm. Maximum torque 111.0 ft-lbs (150.5 N-m) at 1600 rpm. 12V, 60-amp alternator.

Hydrostatic Transmission Pump:**Standard:**

Sauer-Danfoss piston type, 2.8 CID (45 mL) per revolution, direct driven from engine crankshaft. Maximum flow 34 gpm (129 L/min) maximum pressure 4,000 PSI (275 bar). Electrohydraulic servo and electronic, automotive type controller.

Axles:**Standard:****Front Axle:**

Channel shaped structure houses torque hubs, brakes and hydraulic drive motors. Front axle oscillates a total of 1.5 inches (38 mm) to minimize wheel spin on uneven surfaces.

Rear Axle:

Fixed rigid to frame. Box beam crossmember and thrust bearing supported wheel hubs.

Steering:**Standard:**

Full-hydraulic steering unit controls 2.5-inch (63 mm) steering cylinder attached to rear axle. Limited steering if engine dies.

Brakes:**Standard:**

Primary braking from hydrostatic transmission. Foot-actuated disc brake attached to each torque hub for additional braking in some conditions. Parking brake switch locks brakes to hold crane when not being driven.

Tires:**Standard:**

7.50 x 10 pneumatic tires, 16-ply. Pressurized to 150 PSI (1000 kPa) for crane rated loads.

Optional Tires:**Solid Rubber Tires:**

For applications where hazardous ground conditions exist. These tires do not change the overall height or ground clearance.

Net Weight: 240 pounds (109 kg)

Solid Rubber Tires, Non-Marking:

Same as solid rubber tires except non-marking.

Net Weight: 240 pounds (109 kg)

Foam-Filled Tires:

Standard tires, foam filled to prevent flats.

Net Weight: 312 pounds (142 kg)

Spare Tire & Wheel:

7.50 x 10 pneumatic tires, 16-ply. Front or rear axle must be specified.

Net Weight: 80 pounds (37 kg)

Chassis:**Standard:****Cargo Deck:**

29-square foot (2.7 m²) area. A maximum of 6,000 pounds (2720 kg) may be carried on the deck when centered over or to the rear of the front axle. Nine stake pockets are provided in deck and nine, 1.3-inch (34 mm) outside diameter pipe stakes.

Outriggers:

Four hydraulic outriggers with box beam construction. Independent controls for each. Hydraulic cylinders are equipped with direct connected holding valves. Pad dimensions are 6 inches (152 mm) by 8 inches (203 mm).

Lifting Rings:

Includes four lift rings, one at each corner of the chassis for attaching lifting sling cables.

Front Pulling Eye:

Heavy eye in front bumper provides for attachment of hook block so main winch line can be used for pulling loads at or near floor level.

Headlight and Taillight Grilles:

Consists of welded steel protective grilles for headlights and taillights. Easily removes or swings out of way for replacing bulbs.

Optional Chassis Accessories:**Auxiliary Winch:**

Optional worm gear winch mounted behind front bumper, with a single lever control at the operator's console. Hydraulic powered to provide bare-drum line pull of 3,000 pounds (1360 kg) at 20 ft/min (6 m/min). Winch drum is 3.5-inch (89 mm) dia. by 6.2 inches (159 mm) long. The winch includes 80 feet (24.3 m) of 5/16-inch (7.94 mm) wire rope, hook, and four-way roller guide.

Net Weight: 120 pounds (55 kg)

Pintle Hook:

T-60-A Holland pintle hook mounted on rear frame member. Rated for 10,000-pound (44 kN) pull and 2000-pound (8.9 kN) vertical load.

Net Weight: 7 pounds (3 kg)

Lifting Sling:

Sling to attach to lifting rings.

Net Weight: 20 pounds (9 kg)

Rear View Mirrors:

One right-hand and one left-hand mirror, 6-inch (152 mm) diameter, mounted on deck stakes. Pivot out of way when contacted by obstacle at side of deck.

Net Weight: 12 pounds (6 kg)

Operator's Compartment:**Standard:**

Operator control station provides one-position access to all chassis and crane functions. Includes adjustable operator's seat and retracting seat belt.

Operator's Compartment Accessories:**All Weather Cab:**

Consists of rigid mounted canopy section and removable hinged door with safety glass. Rugged canopy structure with laminated glass front and top. Door is equipped with a keyed lock to protect operator's station. Cab door adds 4 inches (102 mm) to crane width on operator's side. Includes heater with two-speed fan and 12V electric windshield wiper. Includes sliding window in the door and one fold out window in rear to provide flow-through ventilation. Defroster fan and dome light included.

Net Weight: 180 pounds (82 kg)

Cab Heater:

Heater with two-speed fan, for units without All Weather Cab.

Net Weight: 15 pounds (7 kg)

Operator Guard:

Tubular steel weldment with heavy expanded steel mesh top bolts over operator's compartment.

Net Weight: 60 pounds (27 kg)

Operator Guard Cover:

Vinyl cover with windows to go over operator guard for inclement weather operations.

Net Weight: 12 pounds (6 kg)

Floormat:

Ribbed vinyl mat with foam backing for operator comfort.

Electrical System:**Standard:****Electrical Group:**

12V DC.

Battery:

Group 24 with 550 CCA rating.

Lighting Group:

Consists of two headlights, taillights, and 12V horn activated by button on instrument panel.

Display:

Located at operator's station and includes fuel gauge, voltmeter, oil pressure, water temperature and hydraulic oil temperature gauges. Hour meter records hours only during actual engine operation.

Outrigger Alarm System:

112 dB alarm with alternating two-tone sound is actuated by a switch when the OUTRIGGER DOWN controls are operated.

Back-up Alarm:

Provides pulsating 97 dB sound from solid-state alarm when ignition is on and transmission is in reverse.

Optional Electrical Accessories:**Strobe Lights:**

Two yellow strobe lights mounted on turret for high visibility. Flash 60-120 times per minute. Draw 1/2 amps each. Includes operator-controlled switch.

Boom Work Lights:

Two work lights, one on side of boom to light boom tip, and one on side of turret to light ground under boom tip. Includes switch at operator's station.

Net Weight: 10 pounds (5 kg)

Hydraulic System:**Standard:**

Tandem pump mounted to rear end of hydrostatic piston pump, which is driven by the engine crankshaft. Delivers 6 gpm (23 L/min) at 2,600 PSI (179 bar) for boom circuits and 17 gpm (64 L/min) at 2,250 PSI (155 bar) for hoist circuit. System protected by relief valves and two, 10-micron filters. Hydraulic reservoir with 14-gallon (53 L) capacity.

Boom Assembly:**Standard:**

Three section, high strength steel construction, equipped with bearing pads for efficient support and extension. Double-acting hydraulic cylinders extend boom sections. The primary extension cylinder and the double-acting boom elevation cylinder are equipped with direct connected holding valves. Boom angle indicator provided on both sides of boom.

Main Hoist:**Standard:**

Turret mounted, planetary gear hoist is hydraulically powered to provide bare-drum line pull of 5,000 pounds (2268 kg) and a line speed of 86 ft/min (26 m/min).

Main Hoist Rope:

Hoist includes 85 feet (26 m) of 3/8-inch (9.5 mm) wire rope, downhaul weight, swivel hook, and sheave block for 2-part line. (Required for lifts over 4,000 pounds (1814 kg). Sheave block weight is 60 pounds (27 kg). Downhaul weight is 40 pounds (18 kg). Main hoist rope is 3/8" (10 mm) diameter, Warrington-Seale construction, 6x36 classification, EIP grade, IWRC core, RRL lay, minimum breaking strength 15,100 lbs (67 kN), 85 feet (26 m) long. Weight per foot is 0.3 lbs (0.5 kg per m). Note that rope weight is not included in load calculations.

Optional:**Extra-long Wire Rope:**

140-foot (42.6 m) long load line instead of standard 85-foot (26 m).
Net Weight: 14 pounds (7 kg)

Boom Swing:**Standard:**

Heavy-duty ball bearing rotation gear with external teeth supports boom. Rotation is powered by hydraulic motor and worm gear drive. 360 degree continuous rotation.

Boom Attachments:**Anti-Two-Block Device:**

Has electric solenoid dump valve, which prevents damage to hoist rope and machine components from accidentally pulling load hook against boom tip. This valve will dump the HOIST RAISE, TELESCOPE EXTEND, BOOM LOWER, and SWING LEFT RIGHT circuits. No other circuits are affected. These circuits are returned to normal operations by operating the HOIST LOWER or TELESCOPE RETRACT control. This system uses a trip arm to activate switch.

Downhaul and Sheave Block:

Includes downhaul weight and hook for single part line. Downhaul and hook assembly weight is 40 pounds (18 kg). Downhaul is designed to clamp dead end of rope. Also includes sheave block for two-parting line for lifts over 4000 pounds (1800 kg). 7-inch (18 cm) OD sheave is grooved for 3/8-inch (10 mm) wire rope. Sheave block weight is 60 pounds (27 kg). Both attachments are specially designed to actuate the Anti-Two-Block system.

Rated Capacity Limiter:

Operator's aid that warns operator of impending overload with audible and visual signals. Has read-outs for load, boom angle, boom length and load radius. In the event of an overload, dumps the following boom functions: HOIST RAISE, TELESCOPE EXTEND, BOOM LOWER, SWING LEFT, and SWING RIGHT. These circuits are returned to normal by lowering load to a safe resting place with hoist or by retracting or raising boom to a shorter load radius. Key-operated, momentary override switch located under dashboard.

Optional Boom Attachments:**Boom Extension, 8-Foot (2.4 m):**

Provides 8 feet (2.4 m) of additional length for lifting loads with load line. Boom extension may be stowed along side base boom section when not in use. Tip sheave, attaching brackets, and pins included. Deduct 100 pounds (45 kg) from Capacity Chart when boom extension is in stowed position. Includes switch and trip arm for Anti-Two-Block system.
Net Weight: 130 pounds (59 kg)

Boom Extension, 8-Foot (2.4 m) Offset:

Same as standard boom extension, except has three settings: 0 degrees (in-line), 15 degrees offset, and 30 degrees offset.
Net Weight: 150 pounds (68 kg)

Searcher Hook:

2000-pound (907 kg) capacity. Swivel hook with spring latch hangs from support structure, projecting outward from boom tip.
Net Weight: 30 pounds (14 kg)

Specifications subject to change without notice.

OPERATION

SAFETY RULES

GENERAL:

1. Since the manufacturer has no direct control over machine application and operation, conformance with good safety practice is the responsibility of the user and his operating personnel.
2.

 DANGER
YOU MUST NOT OPERATE THIS MACHINE UNLESS YOU ARE QUALIFIED BY TRAINING AND EXPERIENCE IN THE SAFE OPERATION OF THIS MACHINE
TRAINING INCLUDES COMPLETE KNOWLEDGE OF YOUR EMPLOYER'S WORK RULES, ALL GOVERNMENTAL REGULATIONS AND MANUFACTURER'S OPERATOR AND SAFETY MANUALS RELATIVE TO THIS MACHINE'S SAFE USE.
AN UNTRAINED OPERATOR SUBJECTS HIMSELF AND OTHERS TO DEATH OR SERIOUS INJURY
B-651-00038
3. The operator shall be responsible for those operations under his direct control. Whenever there is any doubt as to safety, the operator shall have the authority to stop and refuse to handle loads until safety has been assured.
4. The operator shall not engage in any practice which will divert his attention while actually operating the crane.
5. This list of rules is only a supplement to all federal, state, and local safety rules that may apply.



CRANE CONDITION:

1. Before beginning operation each day, thoroughly inspect the entire crane to be sure it is in good operating condition.
2. Inspect load hoist rope and wedge socket daily. We recommend rope inspection, replacement and maintenance in accordance with ASME B30.5, Sec. 5-2.4.
3. Keep operator's compartment and decks free of mud and grease.
4. If crane is equipped with a cab, keep all window glass clean. Keep gauges clean.
5. Tools, lubricants, or rags on the crane should be kept in a secured toolbox.
6. Do not use ether for starting. Ether is highly flammable and can be ignited by the intake manifold heater grid, causing engine damage or operator injury.

7.

 WARNING
DO NOT USE CRANE UNLESS CABLE RETENTION PINS ARE IN PLACE OVER CABLE SHEAVE. DOWN HAUL WEIGHT AND HOOK CAN BE PULLED OVER END OF BOOM IF CABLE RETENTION PINS ARE NOT IN PLACE. PERSONS NEAR CRANE CAN BE STRUCK AND SERIOUS INJURY OR DEATH CAN RESULT. A-651-00148

8.

	 WARNING
	NEVER USE ROPE CLIP ON LIVE SIDE OF THE LOAD HOIST ROPE. THIS WILL SERIOUSLY WEAKEN THE ROPE. DEATH OR SERIOUS INJURY CAN RESULT FROM THE USE OF A ROPE CLIP ON THE HOIST ROPE.

9. The Rated Capacity Limiter must be checked before each shift and after each setup for the proper operating configuration on the display. It must be inspected before each shift and tested with a known load at least once a month as described in the RCL operation manual.

LIFTING:

1. Always refer to Crane Capacity Chart in operator's compartment before handling load. Do not exceed load ratings. Under some conditions the standard capacity ratings cannot be recommended and must be adjusted downward to compensate for special hazards, such as weak supporting ground, wind, hazardous surroundings, operator inexperience, etc. The weight of the load should always be known.
2. Be careful to prevent load swinging. A swinging load can cause instability or loss of control of the load. Be aware that the Anti-Two-Block System and the Rated Capacity Limiter can cause sudden stopping of boom movement, which can cause the load to swing. Swing the boom slowly whenever these systems might stop the boom.
3. Do not allow anyone to put any part of his body under a load. The load may lower or fall if there are damaged parts in the crane. Also, the load may drop a short distance due to thermal contraction of the hydraulic oil in the cylinders.

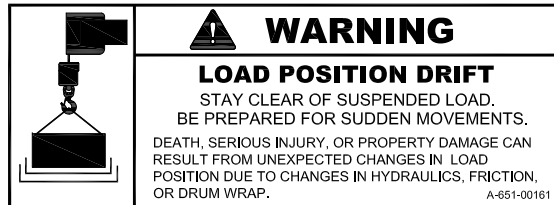

4. Do not use crane to drag loads sideways.



- 5.

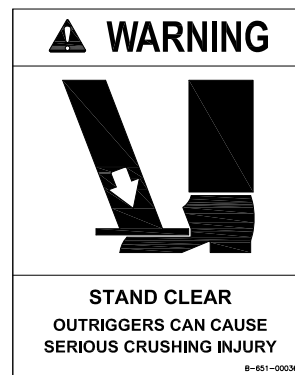

7. Level the crane before lifting. A small incline will significantly reduce the capacity. Use appropriate cribbing under the outriggers for leveling. All outriggers must be fully extended and tires must clear the ground to use the ON OUTRIGGERS ratings.
8. Always use outriggers if possible. If you must lift on rubber, keep the load as close to the ground as possible to prevent tipover. Move the load very slowly and use tag lines to prevent load swinging.
9. Crane may tip at less than rated loads if the surface is uncompacted or wet dirt, or soft soil with frozen crust, thin or cracked pavement, or surface near a hole or ledge. Always use adequate outrigger floats and/or cribbing. See page 2-12.
10. The operator shall not leave the controls while the load is suspended.
11. Always use adequate parts of load hoist line for lifting heavy loads.
12. Always be sure the rope is properly seated and wound level on hoist drum.
13. Keep hands away from load hoist rope when hoist is being operated.

14. Be sure at least five wraps of rope are left on the hoist drum to ensure against rope pulling out of its anchor.

15. Never wrap the hoist rope around a load. Always use approved rigging.

16. Avoid pinch points such as between a rotating turret and the cab or operator guard, or in access holes of a telescoping boom.



17. Avoid two-blocking.

- a. Stop raising hoist line before downhaul or hook block strikes boom tip plates.
- b. Pay out hoist line while extending boom.
- c. Maintain clearance between downhaul weight or hook block and boom tip while booming down.

DANGER

Two-blocking will abruptly stop boom lowering and boom swing as well as hoist and extend. If the boom is moving fast, this will cause the load to bounce or swing, which could cause loss of control of load or tipping.

18. The amount of counterweight supplied with this crane should never be changed. Unauthorized addition of counterweight in the field to increase lifting ability constitutes a safety hazard.

19. Always keep crane boom at least 10 feet (3m) away from electric power lines. (See chart on side of turntable for boom clearance).

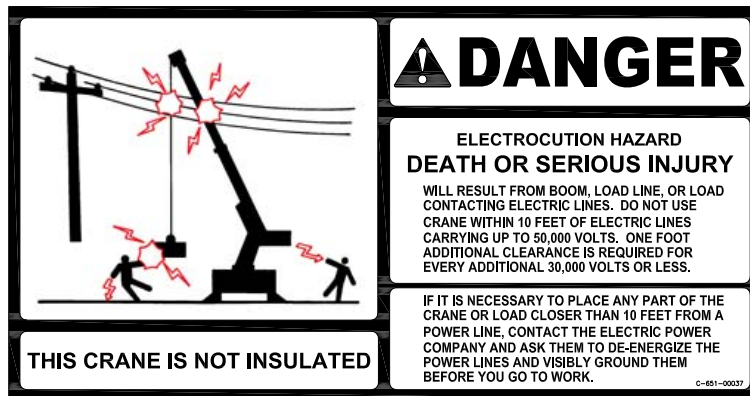

REQUIRED CLEARANCE FOR NORMAL VOLTAGE IN OPERATION NEAR HIGH VOLTAGE POWER LINES AND OPERATION IN TRANSIT WITH NO LOAD AND BOOM OR MAST LOWERED	
Normal Voltage, kV (Phase to Phase)	Minimum Required Clearance ft (m)
Operation Near High Voltage Power Lines	
to 50	10 (3.05)
Over 50 to 200	15 (4.60)
Over 200 to 350	20 (6.10)
Over 350 to 500	25 (7.62)
Over 500 to 750	35 (10.67)
Over 750 to 1000	45 (13.72)
Operation in Transit With No Load and Boom or Mast Lowered	
to 0.75	4 (1.22)
Over 0.75 to 50	6 (1.83)
Over 50 to 345	10 (3.05)
Over 345 to 750	16 (4.87)
Over 750 to 1000	20 (6.10)

REF. ASME/ANSI B30.5 - 1989 B-651-00097

20. If boom should accidentally contact a power line, keep ground personnel away from crane. Stay in the crane until the power source is de-energized. Move the crane away from electrical hazard if this does not cause new hazards. If it is absolutely necessary to leave the crane, **jump** clear of the crane with both feet together. Hop away from the crane with feet together. The ground surface may be energized.

TRAVEL:

1. For Pick and Carry operation: Traveling with suspended loads involves so many variables, such as ground conditions, boom length and vehicle acceleration, that it is impossible to devise a single standard rating procedure with any assurance of safety. For such operations, the user must evaluate prevailing conditions and determine safe practices using precautions, such as the following:
 - A. The boom shall be centered over front axle.
 - B. Use shortest boom practical.
 - C. Carry load as close to ground as practical.
 - D. Reduce travel speed to suit conditions (2 mph (3 km/h) maximum).
 - E. Maintain specified tire pressures.
 - F. Avoid sudden starts and stops.
 - G. Provide tag or restraint lines to snub swinging of the load.
 - H. Hand-held tag lines should be nonconductive.
 - I. Do not carry heavy boom loads and deck loads at the same time.
 - J. Do not pick and carry with boom extension installed.
 - K. Do not exceed the OVER FRONT, ON RUBBER capacity.
2. When raising the boom or moving the unit with boom elevated, be sure there is adequate overhead clearance for boom.
3. For carrying loads on decks:
 - A. Boom must be retracted, centered and lowered as close as possible.
 - B. 2 mph (3km/h) maximum road speed. Reduce speed below 2 mph (3km/h) to properly match condition of road surface and deck load.
 - C. Remove load hook from load before traveling.
4. Cranes with rear steering require close watch because of "tail swing" when the chassis is turned in tight quarters.

5.

 WARNING
OPERATOR MUST KEEP ALL PARTS OF HIS BODY INSIDE OPERATORS COMPARTMENT WHILE OPERATING THIS UNIT.
<small>A-651-00045</small>

6. Every effort has been made to make the BMC Industrial Crane a stable vehicle. However, with the rigid front axle and the unsprung oscillating rear axle suspension, the operator must take care to control the vehicle speed to be compatible with conditions of rough roads or uneven terrain.
7. When this crane is to be parked on a grade, set parking brake and block wheels or extend outriggers fully.

8.

 WARNING
THIS VEHICLE IS EQUIPPED WITH A BACK-UP ALARM. ALARM MUST SOUND WHEN BACKING. OPERATOR MUST MAKE CERTAIN ALARM IS WORKING BEFORE OPERATING THIS VEHICLE.
<small>C-651-00146</small>

9. Shut off engine before refueling, and remove fuel cap slowly. Vapor pressure in tank can cause a burst of fuel and vapor when the cap is removed.







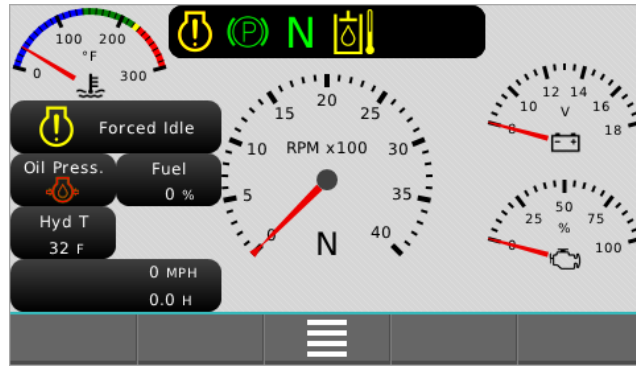

OPERATION

INSTRUMENTS AND CONTROLS

The Broderson IC-35 instrument panel is equipped with a display screen showing electrical system amperage, fuel level, oil pressure, water temperature, hydraulic oil temperature, and engine hours. Also included is a bubble level, to level the machine.



DISPLAY SYMBOLS

 OR 	WIF Sensor Failure
	Oil Pressure; Red = Pressure too high or low Green=OK
	Engine Load %
	Hydraulic Temperature Monitor
	Engine Coolant Temperature
	Parking brake ON
	In Neutral
	Hydraulic Oil Temperature Warning

The IC-35 is equipped with a lighting package, including an on-off switch, two headlights and two taillights. A horn button is located on the instrument panel.

The ignition switch is key operated and has ACC, IGN and OFF positions. The ignition switch should always be turned off (and the key removed) when the vehicle is left unattended.

A neutral safety switch in starter circuit prevents starting engine with the transmission engaged. The control lever must be in neutral to start engine.

The hydrostatic transmission control switch is located on the right instrument panel. It has FORWARD, NEUTRAL, and REVERSE positions. The speed of the transmission is controlled by the engine speed, which is controlled with the accelerator pedal.

A pedal-activated brake is provided to hold the machine on slopes. Normal braking is provided by the hydrostatic transmission when the accelerator pedal is released. The brake pedal actuates disc brakes attached to each torque hub. The parking brake is applied by a lever on the dash.

The steering wheel is directly mounted to the steering control unit of the all-hydraulic power steering system. The system will provide limited steering if the engine stops running.

The Rated Capacity Limiter display and input panel are mounted on the dashboard. Instructions are in the RCL Operation Manual and additional information is in the *Operating the Crane* section, the *Crane Capacity* section, and *Maintenance* Section of this manual.

CONTROL FUNCTIONS

The controls for operating the outriggers, boom swing, boom elevation, boom telescope, and hoist are located on the control panel. The handles are directly connected to the 4-way hydraulic control valves. The placards adjacent to these handles identify the function controlled and the movement resulting from each handle actuation.

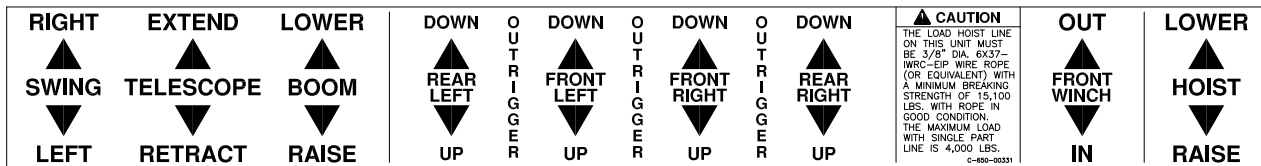

Swing: Pulling back on the lever will rotate the boom to the operator's left; pushing forward will rotate it to the operator's right.

Boom: Pulling back will raise the boom; pushing forward will lower it.

Telescope: Pulling back on the lever will retract the boom; pushing forward will extend the boom.

Hoist: Pulling back on the lever will raise the hook; pushing forward will lower the hook.

Outriggers: The four outriggers may be operated simultaneously or individually. Special attention must be given to avoid hitting personnel or obstacles.

All controls may be used for simultaneous operation to achieve combinations of movements. Some controls must be used together. For instance, the boom telescope and the hoist controls must be used together to maintain clearance between boom and load line hook.

Avoid holding a control lever in the open position after the function has reached the end of its travel. This will impose unnecessary stresses on the components and heat in the hydraulic system.

SEQUENCE OF OPERATION

DRIVING THE VEHICLE

The following procedure is recommended for driving the vehicle to the job site:

1. Perform the daily inspection and test. (See Page 3-4)
2. Apply park brake.
3. Leave hydrostatic transmission switch in neutral.
4. Start engine and allow a warming period. (If equipped with Safety Shutdown System, depress reset button while starting and for a few seconds after.)
5. While warming the engine, set up the Rated Capacity Limiter configuration.
6. Stow boom over front.
7. Pull hoist line snug.
8. Retract outriggers.
9. Step on the brake pedal.
10. Turn parking brake off.
11. Place transmission switch in FORWARD or REVERSE.
12. Release brake and press on accelerator pedal.
13. Slow down when making turns.
14. Release accelerator pedal gradually to slow down and stop.
15. Step on brake pedal for abrupt stop.
16. Set park brake and outriggers or wheel chocks to park.

To start the engine, the transmission switch must be in NEUTRAL. The switch should always be kept in neutral except for travel. Step on the brake before switching to FORWARD or REVERSE. Then release the brake and push the accelerator pedal to begin travel. Motion begins at engine speed of about 1500 rpm. (Idle speed is about 1050 rpm, and maximum speed is about 2500 rpm for gas and 2700 rpm for diesel.)

The hydrostatic transmission will normally stop the crane on a grade -- but some oil will slip through the wheel drive motors and allow the crane to creep. ALWAYS apply parking brake when operating the crane, or leaving the crane unattended. Also extend the outriggers if possible. Remember the hydrostatic transmission is NOT a parking brake.

On level surfaces the brake pedal is not required for normal stopping. On slopes the operator may have to coordinate the brake and the accelerator to make smooth starts and stops. Emergency stops can be made more quickly by stepping on the brake pedal. This combines hydrostatic braking with the action of the disc brakes. Operating both accelerator and brake pedal with the right foot is preferred. Using the left foot on the brake pedal, while simultaneously using the right foot on the accelerator, will allow the engine to overspeed.

WARNING

Abrupt braking from stepping on the foot brake at travel speeds may cause loss of control of a load on the hook or on the deck. The operator should anticipate stops and slowly let up on the accelerator pedal to make smooth stops.

DANGER

Like other mobile cranes, the IC-35 will tip over more readily than some types of vehicles. The operator should always control the vehicle speed to be compatible with terrain or road conditions.

OPERATING THE CRANE

The following procedure is recommended for placing the crane in operation:

1. Perform daily inspection and test. (See Page 3-4)
2. Apply park brake.
3. Leave transmission control switch in neutral.
4. Start engine and allow a warming period at low rpm engine speed.
5. While warming the engine, set up the Rated Capacity Limiter configuration.
6. Move accelerator pedal to medium to full speed.
7. Set all outriggers fully down on firm, level surface. Use timber or steel plate cribbing under outrigger shoes as needed on soft ground. Outriggers should remain set during all crane operations except for pick and carry.
8. Meter the controls when beginning or terminating movement, to prevent sudden starting or stopping, imposing undue shock loads on the equipment, especially when handling heavy loads. The control should be slightly actuated to begin movement and then slowly increased to desired speed. The throttle may be moved to high position for maximum operating speed.
9. Release accelerator during idle time.

NORMAL GAUGE READINGS

Engine Coolant Temperature - Allow engine to warm up before operating crane. Stop engine if temperature exceeds 220°F (104°C).

Engine Oil Pressure - Stop engine if oil pressure does not exceed 10 PSI (0.7 bar) at low idle. Pressure varies with engine rpm.

Voltmeter - The voltmeter should read about 13 to 14 volts when the engine is running.

Hydraulic Oil Temperature - Normal operating temperature is in the range of 75°F to 200°F (24°C to 93°C). If the reading on the gauge (which starts at 100°F (38°C)) exceeds 200°F (93°C), shut down the unit and determine the cause of excessive heating.

Level Indicator - Do not operate crane if it is not level.

Fuel - Do not allow fuel tank to become empty. The engine will be difficult to restart and may require "bleeding" of diesel injectors. Keep tank full when idle to prevent condensation in tank.

WARNING

Vapors can be formed inside a fuel tank and cause a buildup of pressure that can result in a sudden expulsion of gasoline and gasoline vapors from the filler neck when the fuel cap is removed from a hot tank. Remove cap slowly. Fuel spray may cause injury.

RATED CAPACITY LIMITER (RCL)

A Rated Capacity Limiter is installed on the crane to assist the operator in estimating loads and measuring load radii. Please read the RCL Operation Manual for complete instructions on operation of the system. Following are some additional operating tips. Always be aware that the RCL can stop boom movement at capacity load conditions and in two-blocking conditions. Use good judgment in controlling the speed of boom movements to prevent shock loads and swinging loads.

If the RCL system stops the crane movement there are various remedies that may be used to restart operation. If the hook is two-blocked, it should be lowered using the HOIST control, if safe. The BOOM RAISE and TELESCOPE RETRACT may also be used if this is safer. In some unusual circumstances it may be necessary to swing the boom before lowering the load. If you are sure this will not cause an overload, you can turn the override key that is under the left instrument panel and swing the boom to a safer position.

If the load is the maximum for the loadline or attachment, the load should be set down in a safe place using the HOIST LOWER control and the load or attachment changed. TELESCOPE RETRACT may also be used and swing may be used, if safe, as described in the preceding paragraph. DO NOT use the BOOM RAISE control as this may increase the overload.

If the load is at the maximum allowable load radius, the boom can be raised or retracted to a safe radius or the load may be lowered to a safe place using the hoist control. If the boom extension is at its angle limit, the boom must be raised or the load hoisted down.

If the boom is fully lowered until it stops, (about 0°) the RCL will show an overload condition because the boom lift pressure sensors cannot read a useful pressure in this condition. To remedy this, raise the boom slightly. On the other hand, if the boom is fully raised, (about 70°) the RCL may show an overload condition because the pressure in the boom lift cylinder is sensed to be an overload. To correct this condition, the override key may be turned and held, and the boom lowered just slightly. Then check for other conditions before lowering further.

If there is a malfunction of the RCL or Anti-Two-Block system that causes loss of boom movement and cannot be remedied by the procedures above, the override keyswitch under the dashboard may be required to move the boom.

WARNING

We recommend the emergency override switch be used with discretion. Improper or careless use of this switch can cause damage to the crane and endanger people and property. The operator who uses the switch in an emergency should use good judgment.

There is a light on the dashboard to warn that one or more outriggers is not fully extended when using the ON OUTRIGGERS setup on the RCL. Check the light daily when the outriggers are down and there is no load on the hook by raising and lowering each outrigger about three inches. The light should come on when an outrigger is up.

CRANE CAPACITY

Before lifting loads, the operator must read the **Crane Capacity Chart** and adhere to the load capacities and radii of handling given. The information provided on this chart is based on stability, structural strength and hydraulic capacity.

To operate the crane safely, the operator must know the weight of the load and handling devices and the radius of the lifting operation. The crane must not be loaded beyond the specifications of the capacity chart except for test purposes as provided in ASME B30.5 Section 5-2.2. The person responsible for the lift must be sure that the load does not exceed the crane ratings at any radius at which the load may be during the entire lifting operation. The weights of the hooks, blocks, downhaul weights, slings, and other handling devices must be added with the load. Please read the RCL Operation Manual.

The **Rated Capacity Limiter** on the crane is intended to assist the operator in estimating loads and measuring load radii and to alert the operator to impending overload conditions. The use of the Rated Capacity Limiter does not replace the requirements of the preceding paragraph. Verified weights and measured radii must take precedence over the Rated Capacity Limiter readings.

The Rated Capacity Limiter displays a load, load radius and boom angle that are obtained from electronic calculations using readings from pressure, length and angle sensors. These readings cannot be exact and should be treated as estimates. In general, the smaller the load and the higher the boom angle, the larger the percent of error, and the electronic and mechanical components cannot be 100% fail-safe.

Do not consider the system as a substitute for good judgment, training, experience or accepted safe operating practices. The operator is solely responsible for operation of the crane. Setting the Rated Capacity Limiter for the configuration of the crane is necessary before starting a lift. If incorrectly set, the system will not alert the operator to an impending overload, possibly resulting in the loss of life or destruction of property.

If the Rated Capacity Limiter is inoperative or malfunctioning, repair or recalibration of the unit must be done as soon as reasonably possible, and the person responsible for lifts must establish procedures for determining load weights and radii, and conduct the lifts according to the second paragraph above.

The Rated Capacity Limiter is designed to stop crane functions that could cause an overload or two-blocking. These are: BOOM LOWER, TELESCOPE EXTEND, HOIST RAISE, SWING LEFT and SWING RIGHT. Great care must be exercised when handling a load near capacity or near a two-blocking condition. If the boom is being lowered or swung, the load will tend to swing if the Rated Capacity Limiter stops the boom movement. If the load is moving too fast, the sudden stopping by the system can cause dangerous load swinging, which can cause death or injury to personnel or property damage by impact with the load, or by the crane tipping.

WARNING

The Rated Capacity Limiter can suddenly stop the BOOM LOWER and SWING functions, causing the load to bounce or swing. Use great care when handling a load near capacity limits or near a two-blocking condition.

CRANE CAPACITY CHART DEFINITIONS AND RULES:

The load radius is the horizontal distance from the centerline of boom rotation (the center of the turntable when it is level), to the vertical load line with the load suspended. Because of deflections of the boom and carrier, the load radius increases when a load is hoisted from its resting place. The load radius may be measured with a measuring tape. If the desired load radius falls between two load radii on the chart, it is recommended to use the load radius with the lower capacity and not try to interpolate between the numbers.

Load capacity ratings on this equipment are given on the basis that operations are to be conducted on firm and level terrain and in a safe environment. These capacity ratings are reduced in proportion to the deviation from the prescribed conditions. Any unfavorable environmental condition, such as soft, sloping or uneven terrain, high wind, or hazardous surroundings constitutes a deviation.

The main boom capacities are given in direct relation to the radius at which the load is being handled. Boom extension capacities depend on the boom angle as well as the load radius. The capacities shown on the capacity chart are the maximum allowable at the indicated radius. The greatest load that may be handled by the BMC IC-35 is 8,000 pounds (3630 kg), but only at a 4-foot (1.2 m) radius, and on outriggers. All variances of loads and radii of handling are shown on the crane capacity chart. A metal chart is attached near the operator's seat and a laminated chart is included in the literature compartment for the express purpose of informing the operator when a load can or cannot be safely handled.

The capacities shown in the 360° ROTATION columns of the capacity chart apply to the entire 360° rotation of the boom and are maximum allowable at the indicated radius. The capacities OVER FRONT are limited as follows:

On Outriggers: Boom rotation is limited to an arc of 15° either side of the crane centerline.

On Rubber: Boom rotation is limited to the boom centered over front. Pick and carry operations are limited to the boom centered over front.

Note that the 360° ROTATION capacities at some load radii are much less than the OVER FRONT capacities. The least stable position of the boom is over the side of the crane.

Use great care when swinging a load from the front or rear of the crane toward the side of the crane. The load must be known in order to assure that the crane will not tip.

NOTICE

Under certain load conditions, torsion induced in the chassis can cause it to twist. This may result in an opposite-side outrigger or tire lifting free from the supporting surface. This is most likely to occur when the boom is positioned over one corner of the machine. The condition does not indicate a loss of stability when working within the limits of the capacity chart. Provided the crane capacity has not been exceeded, operation may continue without restriction.

CAUTION

A capacity load may be carried on the boom, or a capacity load may be carried on the deck. **DO NOT** carry capacity deck loads and capacity boom loads at the same time.

CAUTION

The capacities of this crane are based on all outriggers being **FULLY EXTENDED** to a **FIRM, LEVEL** surface. The crane may tip at less than capacity loads if operated in the following manner:

- A. Outriggers only partially extended and resting on curbing, shoring, etc. If the outriggers are not all the way **DOWN**, they are not all the way **OUT**.
- B. Outriggers extended to a surface that appears to be firm, but is unable to support the outrigger pad at full rated loads. Examples of this type surface are:
 - 1. Thin or cracked blacktop or concrete.
 - 2. Dirt that appears dry and firm on top, but is moist or unpacked beneath the surface.
 - 3. Dirt with a frozen but thin crust.
- C. Crane operated on a hill or sloping surface. Crane will tip at less than rated capacity when load is lifted on downhill side.

CAPACITY EXAMPLE

Refer to the IC-35-2G Capacity Chart on the following page. A load weighing 4500 pounds (2040 kg) is to be lifted onto the deck of the crane for transport to a new location. The closest we can get to the load is at a 6-foot (1.83 m) load radius over the side. We see on the chart that 4000 pounds (1815 kg) is the maximum load on one-part line, so the sheave block is required. The charts show the weight of the standard sheave block to be 60 pounds (27 kg). The rigger says that two slings are required, weighing a total of 40 pounds (18 kg). The total load is $4500+60+40=4600$ pounds (2086 kg).

Looking at the 360° ROTATION, ON RUBBER column we see that the load is too heavy for this condition. The OVER THE FRONT, ON RUBBER column shows that we can lift 5100 pounds (22120 kg) at a 6-foot (2 m) load radius. However, we cannot get that close to the load, so the load cannot be lifted this way. This leaves the ON OUTRIGGERS columns. The outriggers should always be used whenever possible anyway. We see that we can lift up to 5850 pounds (2420 kg) at a 6-foot (2 m) load radius, either over the front or over the side. Checking the chart again, we see that the load is within the deck load limit of 6000 pounds (2720 kg). **Note:** The travel speed with the load must be limited to 3 mph (4 km/h) -- or less if conditions dictate.

REMEMBER THAT AS THE BOOM IS LOADED, DEFLECTION OF THE BOOM, TIRES, ETC., WILL INCREASE THE LOAD RADIUS. SO BE CONSERVATIVE IN YOUR CAPACITY ESTIMATE.

CRANE CAPACITY CHART FOR IC-35-2G

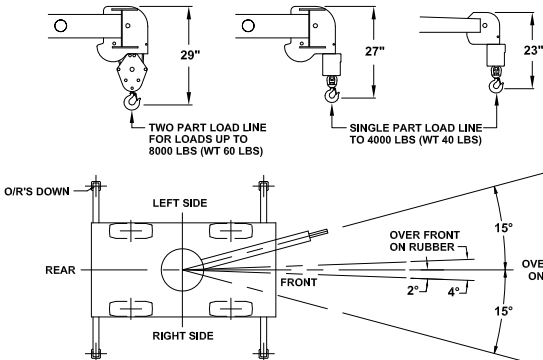
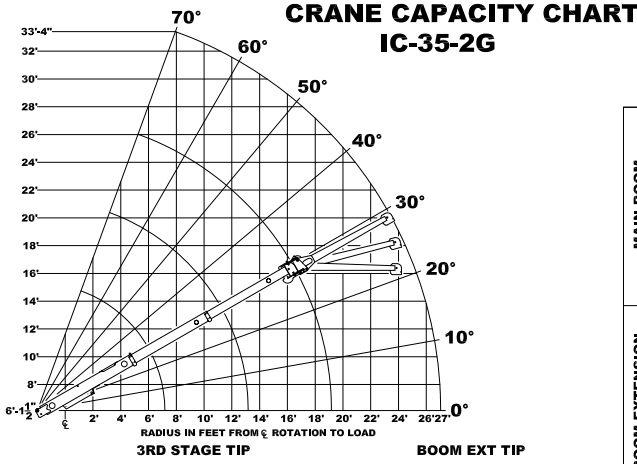

LOAD RADIUS IS THE HORIZONTAL DISTANCE FROM THE CENTER OF ROTATION OF THE UNLOADED CRANE TO THE VERTICAL LOAD LINE WITH THE LOAD APPLIED.

LOAD HOOKS, DOWNHAUL WEIGHTS, HOOK BLOCKS, AND OTHER LOAD HANDLING DEVICES EXCEPT HOIST ROPE SHALL BE CONSIDERED PART OF THE LOAD.

PICK AND CARRY WITH THE SHORTEST PRACTICAL BOOM, CENTERED OVER THE FRONT. OPERATE WITH THE BOOM AS LOW AS POSSIBLE, WITH THE LOAD CLOSE TO THE GROUND. PICK AND CARRY CAPACITIES ARE FOR SMOOTH, LEVEL PAVED SURFACE.

DECK LOAD 6000 LBS MAX. CENTERED BETWEEN WHEELS. WITH NO BOOM LOAD. DECK LOADS MUST BE CENTERED BEHIND THE FRONT AXLE. SPEED MUST BE LESS THAN 2 MPH. MAXIMUM TRAVEL 200 FT. IN 30 MINUTES.

CAPACITIES APPLY TO OPERATION ON FIRM LEVEL SURFACE

LOAD RADIUS FEET	MAIN BOOM OR EXTENSION CAPACITIES IN POUNDS			
	360° ROTATION		OVER FRONT	
	ON RUBBER	ON OUTRIGGERS	ON RUBBER	ON OUTRIGGERS
4	5000	8000	6700	8000
5	4000	6800	5800	6800
6	2850	5850	5100	5850
8	1800	4150	3500	4150
10	1250	3200	2350	3400
12	900	2350	1750	2850
14	700	1850	1350	2450
16	600	1500	1100	2150
18	500	1250	950	1950
19	450	1150	900	1850
20	400	1100	850	1600
22	300	900	700	1450
24	250	800	600	1300
26	200	700	500	1150
27	150	650	450	1100

BOOM EXTENSION ANGLE	8-FOOT BOOM EXTENSION - STRAIGHT OR OFFSET							
	MAIN BOOM ANGLE							
ANGLE	0°	10°	20°	30°	40°	50°	60°	70°
+* 0°	1100	1200	1300	1450	1600	1850	2300	3500
* 15°	—	—	1100	1250	1350	1500	1700	2050
* 30°	—	—	—	1100	1200	1300	1450	1600

* USE 0° FOR STRAIGHT BOOM EXTENSION.
 * USE 0°, 15° OR 30° FOR OFFSET BOOM EXTENSION.

EXCEEDING CAPACITY RATINGS OR APPLYING SIDE LOADS TO THE BOOM OR BOOM EXTENSION IS MISUSE, IS HAZARDOUS, AND VOIDS WARRANTY.

CAUTION: BOOM EXTENSION LOADS MUST NOT EXCEED MAIN BOOM CAPACITY. BOOM EXTENSION DEDUCT: 100 LBS. WHEN STOWED ON BASE BOOM. DO NOT PICK & CARRY WITH LOADS ON BOOM EXTENSION. ENSURE ANTI-TWO-BLOCK SWITCH IS FUNCTIONAL AFTER DEPLOYING OR STOWING BOOM EXTENSION.

CAPACITIES ON OUTRIGGERS ARE 85% OF TIPPING LOADS. CAPACITIES ON RUBBER ARE 75% OF TIPPING LOADS. CAPACITIES BELOW BOLD LINE ARE LIMITED BY TIPPING. OTHER CAPACITIES ARE LIMITED BY STRUCTURAL OR HYDRAULIC CAPABILITIES.

BOOMS ON THIS UNIT ARE ALL STEEL AND HAVE NO LINE VOLTAGE RATING.

THE LOAD LINE ON THIS UNIT MUST BE 3/8 DIA. 6X36 EIP RRL IWRC WIRE ROPE (OR EQUIVALENT) WITH A MINIMUM BREAKING STRENGTH OF 15,100 LBS. 85 FEET LONG.

OPERATION:

1. READ AND UNDERSTAND OWNERS MANUAL BEFORE OPERATING THIS CRANE.
2. CHECK LEVEL OF ENGINE OIL AND HYDRAULIC OIL DAILY.
3. CHECK UNIT FOR VISIBLE DEFECTS DAILY.
4. EXTEND OUTRIGGERS FULLY IF POSSIBLE, IF NOT, USE "ON RUBBER" CHART.
5. AVOID QUICK STARTS AND STOPS WHEN OPERATING OR DRIVING CRANE.

TIRE PRESSURE: 145 PSI FOR 7.50 X 10-16PL. MAXIMUM HYDRAULIC PRESSURE 2600 PSI.

MODEL NO. SERIAL NO. DATE OF MFR.

IC-35-2G		
-----------------	--	--

BRODERSON MANUFACTURING CORP.
LENEXA, KANSAS

65401031

CRANE CAPACITY CHART FOR IC-35-2G METRIC

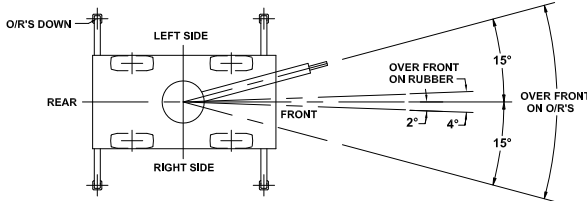
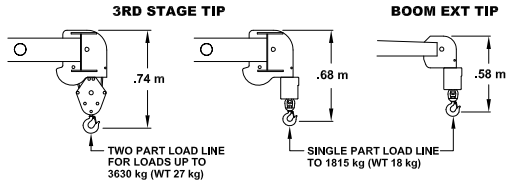
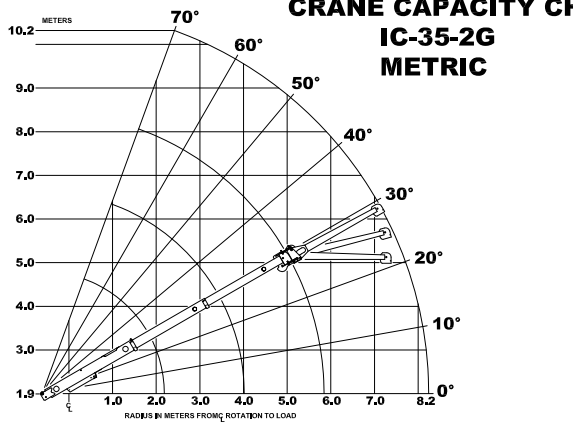

LOAD RADIUS IS THE HORIZONTAL DISTANCE FROM THE CENTER OF ROTATION OF THE UNLOADED CRANE TO THE VERTICAL LOAD LINE WITH THE LOAD APPLIED.

LOAD HOOKS, DOWNHAUL WEIGHTS, HOOK BLOCKS, AND OTHER LOAD HANDLING DEVICES EXCEPT HOIST ROPE SHALL BE CONSIDERED PART OF THE LOAD.

PICK AND CARRY WITH THE SHORTEST PRACTICAL BOOM, CENTERED OVER THE FRONT. OPERATE WITH THE BOOM AS LOW AS POSSIBLE, WITH THE LOAD CLOSE TO THE GROUND. PICK AND CARRY CAPACITIES ARE FOR SMOOTH, LEVEL PAVED SURFACE.

DECK LOAD 2720 kg MAX, CENTERED BETWEEN WHEELS, WITH NO BOOM LOAD. DECK LOADS MUST BE CENTERED BEHIND THE FRONT AXLE. SPEED MUST BE LESS THAN 3 km/h. MAXIMUM TRAVEL 60 m IN 30 MINUTES.

CAPACITIES APPLY TO OPERATION ON FIRM LEVEL SURFACE

LOAD RADIUS METERS	MAIN BOOM OR EXTENSION CAPACITIES IN KILOGRAMS			
	360° ROTATION		OVER FRONT	
	ON RUBBER	ON OUTRIGGERS	ON RUBBER	ON OUTRIGGERS
1.2	2260	3620	3040	3630
1.5	1850	3120	2650	3120
2.0	1090	2420	2120	2420
2.5	780	1830	1520	1830
3.0	580	1480	1090	1560
3.5	440	1160	850	1350
4.0	350	920	680	1180
4.5	300	770	560	1050
5.0	260	650	480	950
5.8	200	520	410	840
6.0	190	500	390	750
6.5	150	430	340	680
7.0	120	380	290	620
7.5	100	350	250	570
8.2	70	290	200	500

BOOM EXTENSION	2.44 m BOOM EXTENSION - STRAIGHT OR OFFSET							
	MAIN BOOM ANGLE							
ANGLE	0°	10°	20°	30°	40°	50°	60°	70°
+* 0°	500	540	590	660	720	840	1040	1590
* 15°	—	—	500	560	610	680	770	930
* 30°	—	—	—	500	540	590	660	720

* USE 0° FOR STRAIGHT BOOM EXTENSION.
 * USE 0°, 15° OR 30° FOR OFFSET BOOM EXTENSION.

EXCEEDING CAPACITY RATINGS OR APPLYING SIDE LOADS TO THE BOOM OR BOOM EXTENSION IS MISUSE, IS HAZARDOUS, AND VOIDS WARRANTY.

CAUTION: BOOM EXTENSION LOADS MUST NOT EXCEED MAIN BOOM CAPACITY. BOOM EXTENSION DEDUCT: 45 kg WHEN STOWED ON BASE BOOM. DO NOT PICK & CARRY WITH LOADS ON BOOM EXTENSION. ENSURE ANTI-TWO-BLOCK SWITCH IS FUNCTIONAL AFTER DEPLOYING OR STOWING BOOM EXTENSION.

CAPACITIES ON OUTRIGGERS ARE 85% OF TIPPING LOADS. CAPACITIES ON RUBBER ARE 75% OF TIPPING LOADS. CAPACITIES BELOW BOLD LINE ARE LIMITED BY TIPPING. OTHER CAPACITIES ARE LIMITED BY STRUCTURAL OR HYDRAULIC CAPABILITIES.

BOOMS ON THIS UNIT ARE ALL STEEL AND HAVE NO LINE VOLTAGE RATING.

THE LOAD LINE ON THIS UNIT MUST BE 10 mm DIA. 6X36 EIP RRL IWRC WIRE ROPE (OR EQUIVALENT) WITH A MINIMUM BREAKING STRENGTH OF 67 kN. 26m LONG.

OPERATION:

1. READ AND UNDERSTAND OWNERS MANUAL BEFORE OPERATING THIS CRANE.
2. CHECK LEVEL OF ENGINE OIL AND HYDRAULIC OIL DAILY.
3. CHECK UNIT FOR VISIBLE DEFECTS DAILY.
4. EXTEND OUTRIGGERS FULLY IF POSSIBLE. IF NOT, USE "ON RUBBER" CHART.
5. AVOID QUICK STARTS AND STOPS WHEN OPERATING OR DRIVING CRANE.

TIRE PRESSURE: 1000 kPa FOR 7.50 X 10-16PL MAXIMUM HYDRAULIC PRESSURE 180 bar
MODEL NO. **SERIAL NO.** **DATE OF MFR.**

IC-35-2G		
-----------------	--	--

BRODERSON MANUFACTURING CORP.
LENEXA, KANSAS

65401025

SHEAVE BLOCK AND DOWNHAUL WEIGHT

The capacity chart shows the approved hoist rope arrangements. The downhaul weight and sheave blocks supplied by Broderson are specially designed to operate the anti-two-block system. Other blocks or downhauls may bypass this system and create a dangerous condition. Notice the load limit for each hoist rope arrangement.

The keeper pins that pass through the sheave plates must be locked in place with cotters to hold the line on the sheaves. The load line must pass through the center of the downhaul, through the wedge socket, and the dead end clamped in the block, as shown in the figure below.

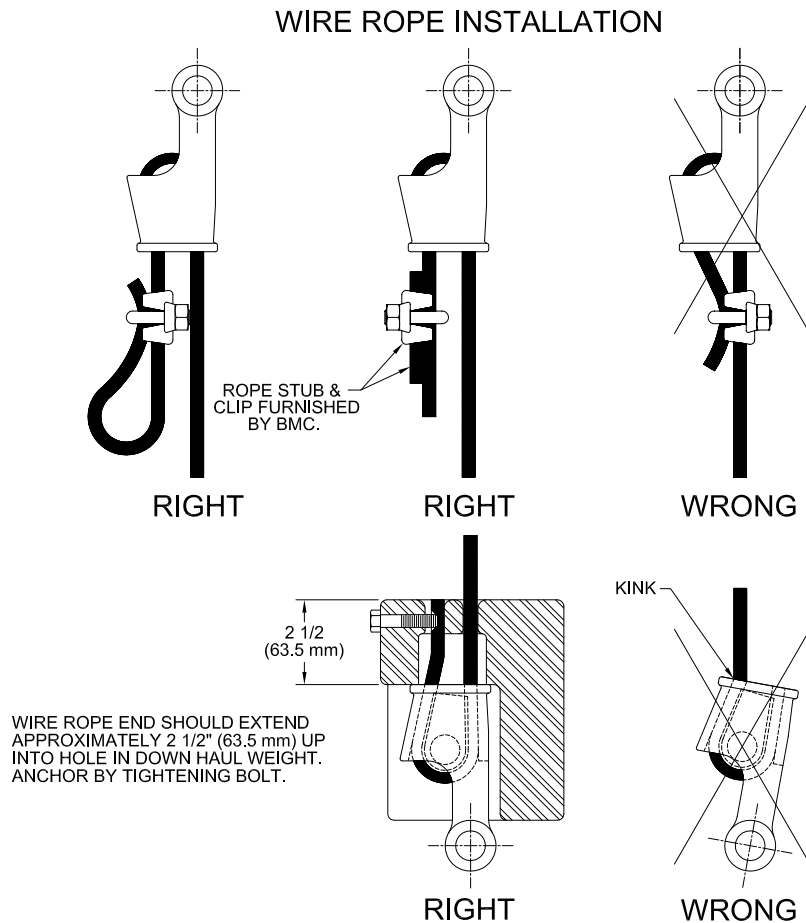

For loads above 4,000 pounds (1815 kg) the sheave block must be used. The wedge socket should be pinned to the boom sheave plates, as shown in the figure. The dead end of the rope in the wedge socket should be clamped, as shown in the figure. The clamp must not be used on the live part of the rope. This will seriously weaken the rope by metal fatigue over a number of cycles. The sheave block should hang straight, and the top of the block should meet the boom sheave plates squarely when pulled up snugly.

TWO-PART LINE REEVING

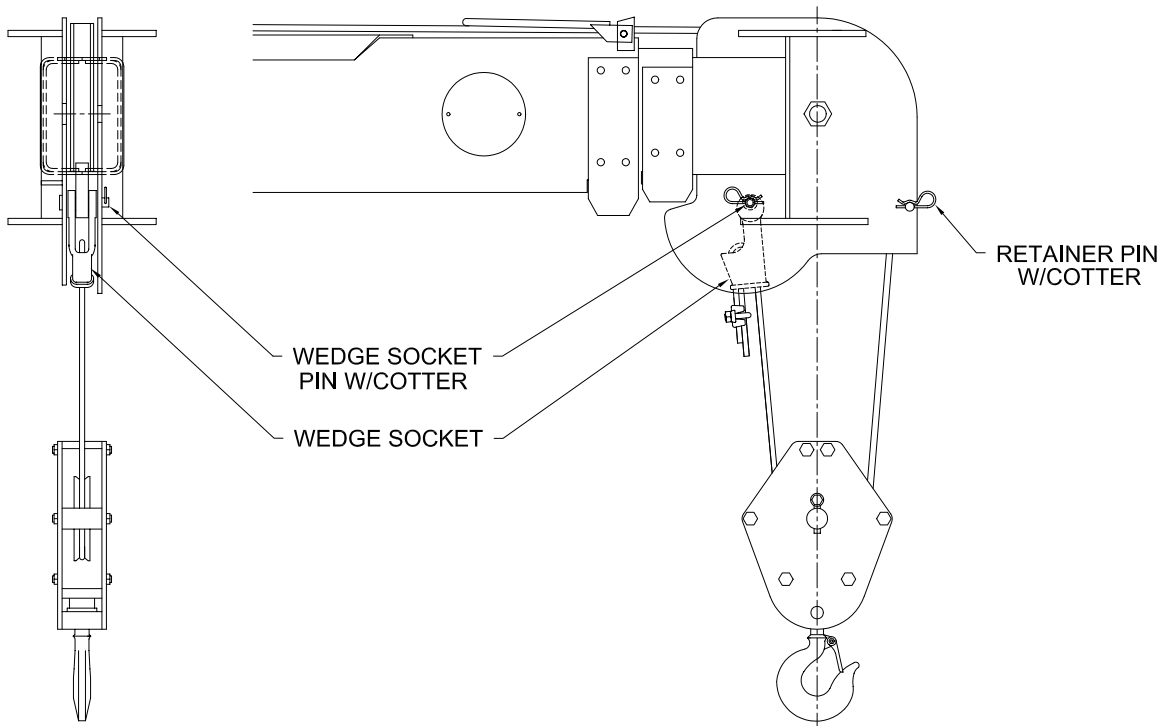

When resting the downhaul or sheave block on the ground for changing it, use the following procedure to prevent fouling the load line on the hoist. Raise the boom about 5 feet (1.52 m) and lower the hoist until the hook nearly touches the ground. Then lay the hook on the ground by lowering the boom, not the hoist.

SAFETY DEVICES

There are safety devices on the IC-35 to maintain control of a load in case of power or hydraulic line failure or human error. The operator should understand the function and operation of these devices, so that a continual check on their performance can be made.

OUTRIGGER CYLINDER CHECK VALVE:

A double-acting check valve is flange-mounted on each of the outrigger cylinders. This valve holds the outrigger in the extended position should power or hydraulic line failure occur. This valve has no adjustment. If an outrigger creeps up while supporting a load, there is an internal leak in the valve or in the outrigger piston seal. In either case, maintenance is required.

BOOM ELEVATION CYLINDER HOLDING VALVE:

A single-acting holding valve is built into the cylinder barrel. This valve holds the boom in the elevated position should power or hydraulic pressure line failure occur. This valve is adjustable to hold the desired load. If the boom creeps down with loads to maximum capacity, this valve should be adjusted. If adjustment fails to correct the problem, there is an internal leak in a holding valve or a hydraulic cylinder. Refer to the maintenance instructions.

BOOM EXTENSION CYLINDER HOLDING VALVE:

A single-acting holding valve is flange-mounted to the cylinder rod end. This valve holds the cylinder in the extended position should power or hydraulic pressure line failure occur. This valve is adjustable to hold the desired load. If the boom creeps in under load, this valve should be adjusted. If adjustment fails to correct the problem, there is an internal leak in the holding valve or the hydraulic cylinder. Refer to the maintenance instructions.

ANTI-TWO-BLOCK DEVICE:

The anti-two-block device prevents damage to hoist rope or machine components from accidentally pulling load hook against boom tip. There is a pivot arm at the boom tip that is moved upward by the load hook as it approaches the boom tip. An electric switch connected to a hydraulic solenoid valve dumps the HOIST RAISE, TELESCOPE EXTEND BOOM LOWER, SWING LEFT and SWING RIGHT circuits. No other circuits are affected. These circuits are returned to normal operation by operating the HOIST LOWER, TELESCOPE RETRACT or BOOM RAISE control.

An emergency override switch is provided so the boom can be operated in case of system failure. This key-operated switch is located under the instrument panel.

WARNING

We recommend the emergency override switch be used with discretion. Improper or careless use of this switch can cause damage to the crane and endanger people and property. The operator who uses this key in an emergency should use good judgment.

WARNING

Even though the crane is equipped with an anti-two-block device, we strongly recommend that the operator always watch the downhaul and stop lifting before two-blocking occurs. Two-blocking can break the load hoist rope and let the load fall. This could cause death or serious injury.

HOIST BRAKE AND HOLDING VALVE:

The hoist has an automatic brake in the gearbox and a holding valve mounted directly on the hoist motor to hold the load. A clutch in the gearbox allows the winch to turn freely in the RAISE direction. The brake is pilot-released in the LOWER direction and should allow smooth stops of a load on the hoist.

OPTIONAL EQUIPMENT

BOOM EXTENSION CAPACITY CHART:

The boom extension will increase the main boom length by 8 feet (2.4 m). The main boom and boom extension capacity charts must both be considered when using the boom extension. The smaller capacity specified by the two charts must be used. **Do not pick and carry with the boom extension installed.**

INSTALLING BOOM EXTENSION ON TIP OF BOOM:

1. Set the outriggers.
2. If the sheave block is installed, remove it.
3. Pay out 20 feet (6 m) of load line.
4. Lower and retract boom and position over front.
5. Remove load line from tip sheaves and lay over left-hand side of boom.
6. Make sure the front stow pin is in place and the attach pins are removed from the lugs on the boom tip, and the mating lugs on the boom extension.
7. Remove the rear locking pin and swing the boom extension away from the rear end of the boom until the attaching lugs mesh on the right-hand side of the boom.
8. Insert the attach pins in the right-hand lugs and retain them with the hairpin cotters.
9. Remove the front stow pin and swing the boom extension around to the front until the left-hand lugs mesh.
10. Insert the left-hand attach pins in their lugs and retain them with hairpin cotters. To insert the fourth pin, it may be necessary to rock boom extension side-to-side, or up & down.
11. Replace the lock pin and stow pin in their brackets for storage and insert their hairpin cotters.
12. Lay the load line over the main boom & extension tip sheaves and insert the cable retainer pins & cotters.
13. Install the downhaul weight, wedge socket and swivel hook on the load line if they are not already installed.
14. Disconnect the anti-two-block wiring cable from the switch on the main boom tip and connect it to the cable connector on the boom extension base.

STOWING THE BOOM EXTENSION:

1. Reverse the procedure described in steps 7 through 14 in the installation procedure above.
2. Lay the load line back in the tip sheaves and insert both retainer pins and cotters.
3. Replace all of the pins in their lugs for storage and insert their cotters.

FRONT AUXILIARY WINCH:

The front auxiliary winch is mounted behind the front bumper and is controlled from the operator compartment. The winch, with the 5/16-inch (7.9 mm) wire rope (10,500 pound (4762 kg) breaking strength) and 2-ton hook, has a single-part-line capacity of 3,000 pounds (1360 kg). A pulling eye is provided below the winch for two-parting the line with a sheave block, allowing 6,000-pound (2720 kg) pulls. (An additional sheave block is not provided with this option.)

The front auxiliary winch is designed for the following uses:

1. As a tag line for restraining loads on the boom load line during pick and carry operation.
2. To drag loads on the ground to a position where they may be safely lifted with the boom.
3. To pull the crane out of mud or other obstacles.
4. To pull a smaller vehicle that is stuck.























WARNING





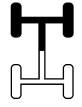

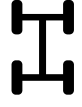





















The front winch is not designed for lifting personnel or loads. Observe the following safety rules:

1. Never lift or carry personnel with the winch and wire rope.
2. Do not allow anyone to stand near or under the load being moved.
3. Be sure the cable is securely anchored in the drum and that at least 5 wraps of rope remain on the drum to ensure against the rope pulling out of its anchor.
4. Stand clear of a loaded winch cable. If it breaks, it can be very dangerous.
5. Keep hands clear of the winch and any sheaves that the cable passes over when the winch is being operated.

SWITCH AND INDICATOR SYMBOLS ON BMC CRANES

The following list shows the symbols used to label switches and indicators on BMC cranes. Most symbols are derived from the ISO 3767-1:1998(E) standard. Not all symbols will be included on your BMC crane.

	On/Start		Windshield washer switch
	Off/Stop		Windshield defroster switch
	Battery not charging		Heater switch
	Hour meter		Air conditioner switch
	Read operator's manual		Ventilation fan switch
	Sound level notification		Parking brake is set
	Headlights (main/high beam)		4-wheel (round) steer
	Work light		Rear-wheel steer
	Hazard lights		Crab steer
	Rotating beacon or strobe lights		2-wheel drive
	Turn signals left/right		4-wheel drive
	Windshield wiper switch		Steering wheel tilt

	Tire pressure		Engine oil pressure low
	Lift point		Engine coolant fill location
	Tie-down point		Engine coolant temperature high
	Transmission oil fill location		Engine coolant low level mark
	Transmission oil pressure		Engine air filter restriction indicator
	Transmission oil temperature		Engine start
	Brake fluid fill location		Engine idle set
	Hydraulic oil low-level mark		Check engine
	Hydraulic oil filter restriction indicator		Stop engine
	Hydraulic temperature gauge		Wait to start/ engine preheat/ grid heater/ glow plug switch
	Hydraulic oil temperature high		Gas fuel only
	Hydraulic oil pressure gauge OR hydraulic oil pressure low		Diesel fuel only
	Positive polarity		Fuel level gauge
	Negative polarity		Drain

MAINTENANCE

SAFETY RULES

1. Lower load and boom, shutdown engine, remove key and put it in a safe place. Place warnings on the ignition switch and crane controls to prevent unauthorized starting or movement during maintenance. Disconnect battery when disabling crane or when welding on crane.
2. Relieve hydraulic pressure when working on hydraulic parts by cycling the controls with the engine shut down.
3. Allow fluids and parts to cool before working on them.
4. Read maintenance instructions before beginning work.
5. Do not check for hydraulic leaks with hands. If a mist of hydraulic oil is noticed around a line or component, use cardboard or other material to check for location of leaks. High pressure fluid leaking from a small hole, can be almost invisible, yet have enough force to penetrate the skin. If injured by escaping fluid, see a doctor at once. Serious reaction or infection can occur.
6. Wear safety glasses and shoes.
7. Do not wear loose-fitting or torn clothing.
8. Remove rings and other jewelry.
9. Wear heavy leather gloves when working on wire rope.
10. Keep clothing and hair away from moving parts.
11. To prevent falls, clean areas of crane that are stepped on for access to crane parts. Wear slip resistant footwear.
12. Avoid placing body parts in pinch points. Use tools that extend through the pinch points when possible. Block the moving parts securely when it is necessary to work in pinch points.
13. When inflating or adding air to a tire, place a tire cage over the tire and use a clip-on inflater chuck with an extension hose that will permit standing behind the tire tread when inflating.
14. Do not work on any machine that is supported only by jacks or a hoist. Always use adequate blocks or jack stands.
15. If it is necessary to work on the boom or outriggers in an unstowed condition, block them to prevent them from dropping unexpectedly.

16. Use a hoist when lifting components that weigh 50 pounds (23 kg) or more. Follow all hoist and rigging safety rules.
17. Do not use lower grade fasteners if replacements are necessary.
18. When reinstalling wiring or plumbing after repairs, be sure that it will not be damaged by rubbing against sharp, rough or hot surfaces, or edges.
19. Never use a rope clip on live side of the load hoist rope. This will seriously weaken the rope. Death or serious injury can result from the use of a rope clip on the hoist rope.
20. Replace any instruction or warning placards that are lost or damaged.
21. Always replace all guards and covers after working on the crane.
22. After working on the hydraulic system, remove air from the lines and cylinders involved by cycling them full stroke with the engine running until the functions operate smoothly.
23. When welding on the crane or on anything connected to the crane by wire rope or other conducting link, disconnect the battery, the Rated Capacity Limiter display & computer, and the engine electronic control module. When welding on the boom or turntable assembly, remove the cable reel and any other electronic components bolted to these assemblies.
24. When using pressure spray to clean the crane, cover all electronic components with sheets of plastic to protect them from spray.

MAINTENANCE

The Broderick IC-35 Industrial Crane will perform better and longer if a program of inspection, lubrication, adjustment and general preventive maintenance is followed. We recommend the following schedule:

NEW UNIT INSPECTION AND TEST

The following inspection and test should be made before placing the unit on the job. This will ensure that no damage or loss of operating capability occurred during shipment.

1. Check for physical damage.
2. Check for leaks at fittings and drips under chassis.
3. Check radiator coolant level.
4. Check engine oil level.
5. Check hydraulic oil reservoir level.
6. Check fuel tank level.
7. Check tire pressure.
8. Check for loose pins, bolts, and retainers.
9. Operate foot brake. Check for operation.
10. Operate park brake. Check for operation and warning light.
11. Operate throttle. Check for operation.
12. Start engine.
13. Check oil pressure.
14. Check ammeter.
15. Check power steering for operation.
16. Check transmission control switch and accelerator pedal for operation.
17. Check lights for operation.
18. Test drive unit and check for normal operation.
19. Check operation of hydraulic outriggers.
20. Check boom swing.
21. Check boom elevation.
22. Check boom extension (pay out hoist cable during power extension).
23. Perform cable break in procedure.
24. Check anti-two-block system for proper operation and cutout of boom functions.
25. Perform a load test according to the Rated Capacity Limiter Operation Manual.
26. Check the outrigger warning light for proper operation as described on page 2-9.

WARNING

When the Rated Capacity Limiter is inoperative or malfunctioning, it must be repaired as soon as reasonably possible. When a lift must be made without a properly functioning RCL, the designated lift supervisor must establish procedures for determining load weights and load radii, and conducting the lift safely.

OPERATOR INSPECTION AND TEST

An operator, in the course of normal operation, should make certain observations, inspections and tests to assure that the unit is ready and able to perform safely.

Daily:

1. Check radiator coolant level.
2. Check engine oil level.
3. Check general condition of tires.
4. Visually inspect for loose pins and physical damage.
5. Check fuel level.
6. Check engine oil pressure.
7. Check engine coolant temperature.
8. Check battery charging amperage.
9. Check hydrostatic transmission temperature.
10. Check hydrostatic transmission control switch and accelerator operation.
11. Check parking brake operation.
12. Check power steering operation.
13. Observe chassis for normal driving operation.
14. Observe boom operation for normal power and speed.
15. Check load line and hooks for damage.
16. Check condition of sheaves and load line retainers.
17. Check hydraulic oil level.
18. Check anti-two-block system for proper operation.
19. Check back-up alarm for proper operation.
20. Check operation of Rated Capacity Limiter according to the RCL User Manual.
21. Check hydraulic hoses, particularly those that flex during crane operation.
22. Check the outrigger warning light for proper operation as described on page 2-9.

Weekly:

1. Check tire pressure -- 145 PSI (1000 kPa).
2. Visually inspect wheel nuts.
3. Check lights.
4. Check power steering lines for damage.
5. Check operation of horn.
6. Check operation of hoist brake for smoothness.
7. Check outrigger holding valves for operation.
8. Check boom cylinder holding valve for operation.
9. Check boom telescope cylinder holding valve for operation.
10. Check swing gears for looseness or backlash.
11. Check operation of windshield wipers (if equipped).
12. Boom extension (if equipped) properly pinned with retainers in place.
13. Clean all glass (if equipped) and check for cracks.
14. Drain water separator.
15. Check brake fluid level.

WARNING

Vapor can form inside a fuel tank and cause a buildup of pressure. This can result in a sudden expulsion of gasoline and vapor from the filler neck when the gas cap is removed from a hot tank. Remove cap slowly. Fuel spray may cause injury.

IC-35 MAINTENANCE CHECKLIST

Refer to the component maintenance section of this manual and to the engine operator's manual for complete instructions.

50 HOUR INTERVAL:

1. 50 hour lubrication as shown on lube schedule.
2. Inspect wire rope thoroughly.
3. Inspect for physical damage and leaks.
4. Check tire pressure and condition (145 PSI (1000 kPa)).
5. Clean radiator fins.
6. Change engine oil and filter after first 50 hours and at 250 hours thereafter.
7. Change the hydraulic filters after the first 100 hours and at 500 hours thereafter.
8. Check rotation gear and pinion fit and gear train backlash.
9. Check rotation bearing and gearbox bolt tightness.
10. Check axle mounting bolts and pins.
11. Torque wheel mounting nuts. (60 ft-lbs (80 N-m) front, 200 ft-lbs (270 N-m) rear)
12. Check for loose pins or pin retainers.
13. Check steering lines for damage.
14. Inspect sheaves and hooks for damage or excessive wear.
15. Perform a load test according to the Rated Capacity Limiter User Manual.
16. Check operation of outrigger warning light as described on page 2-9.
17. Clean air cleaner inlet, dustcap, and dust cup.

250 HOUR INTERVAL:

1. 50 hour maintenance.
2. 50 and 250 hour lubrication.
3. Change engine oil and filter.
4. Check tension of fan and alternator belts.
5. Clean battery.
6. Inspect all bolts for tightness.
7. Visually inspect all welds for cracks.
8. Clean or change air filter (every 100 hours if used in dusty conditions).
9. Check hydraulic fittings for leaks.
10. Inspect air intake system for cracks and leaks.

500 HOUR INTERVAL:

1. 50 and 250 hour maintenance.
2. 50, 250 and 500 hour lubrication.
3. Change fuel filter element.
4. Check antifreeze for protection level and cleanliness.
5. Inspect engine fan and belt.
6. Clean crankcase vent.
7. Adjust engine valve clearance per engine manual after first 500 hours and at 1000 hours thereafter.
8. Change hydraulic filter elements and inspect oil from elements for water or excessive contamination.
9. Check condition of all operational and warning placards.
10. Torque mounting bolts on rotation bearing and gearbox, winch, and axles.
11. Inspect boom sections for signs of overload, excessive wear, or other damage.
12. Replace air filter element.
13. Bleed brakes per page 3-25.

1000 HOUR INTERVAL:

1. 50, 250 and 500 hour maintenance.
2. 50, 250, 500 and 1000 hour lubrication.
3. Adjust engine valve clearance per engine manual.
4. Check and adjust engine speed.
5. Perform engine maintenance specified in engine manual.
6. Change hydraulic fluid & filters and clean breather & reservoir.

1500 HOUR INTERVALS:

1. 50, 250, and 500 hour maintenance.
2. 50, 250, and 500 hour lubrication.
3. Check injector tip per engine manual.
4. Check EGR cooler per engine manual (D1803 only).
5. Change oil separator element per engine manual.

3000 HOUR INTERVALS:

1. Inspect turbocharger per engine manual.
2. 50, 250, 500 and 1000 hour lubrication.
3. 50, 250, 500 and 1000 hour maintenance.

6 MONTH INTERVAL: (For usage less than 250 hours in 6 months)

1. Perform 250 hour maintenance and lubrication.
2. Change hydraulic filter elements and inspect oil.

12 MONTH INTERVAL: (For usage less than 500 hours per year)

1. Perform 6 month maintenance.
2. Perform 500 hour maintenance.
3. Change hydraulic fluid & filters and clean breather & reservoir.
4. Check EGR piping per engine manual (D1803 only).
5. Check intake air line per engine manual.
6. Check exhaust manifold for cracks, gas leaks, looseness, or damage per engine manual.

24 MONTH INTERVAL:

1. 12-month maintenance.
2. Pressure test engine cooling system.
3. Flush cooling system.
4. Change engine thermostat.
5. Fill with new coolant and distilled water.
6. Perform engine maintenance specified in engine manual for 24 month interval.

S/N: _____ HOURS: _____ DATE: _____ BY: _____

COMMENTS & PARTS REQUIRED: _____

ROTATION BEARING LUBRICATION

There is one grease zerk in a hole on the right-hand side of the turntable base plate. This should be used to lubricate the bearing every 50 hours. Rotate the turntable about 45 degrees and pump some grease into the zerk. Repeat until the turntable has rotated two revolutions. Use about 4 ounces of grease each time the bearing is lubricated.

Also, lubricate the gear teeth of the rotation bearing at the 50 hour interval. Remove the pinion cover. Brush open gear grease, such as Mobilkote-S, on the teeth on each side of the pinion at four places around the bearing. Rotate the boom several times and check the coverage of the grease on all of the teeth. Replace the pinion cover.

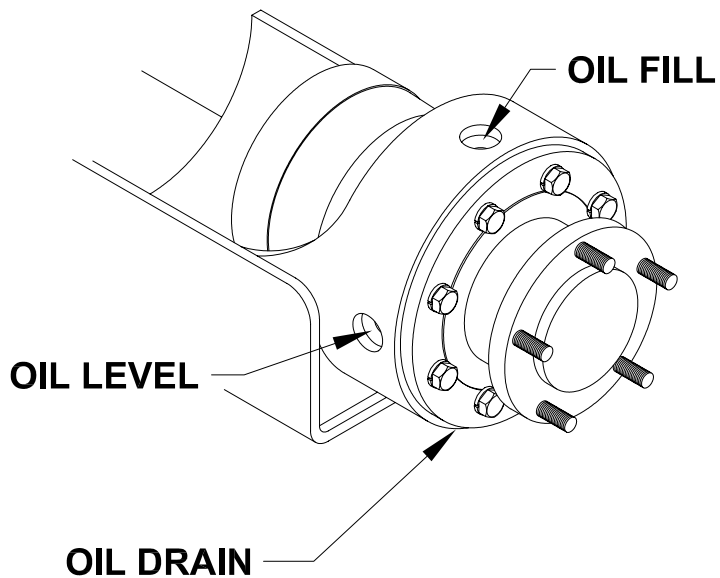

TORQUE HUBS

Use Mobilube HD 80W-90 gear lube or equivalent SAE 80W-90.

On new cranes, drain oil after first 50 hours of use and refill.

Check oil level every 50 hours.

Drain and refill after 1,000 hours of operation or after one year of service, whichever comes first.

WIRE ROPE LUBRICATION

The wire rope should be cleaned and lubricated every 50 hours of normal operation and more frequently when used in dirty or corrosive environments. Whenever the rope is dirty or dry, it should be serviced.

The rope should be cleaned with solvent and compressed air or solvent and rags. A wire brush may be used for difficult areas.

The recommended lubricant is AMOVIS #2-X. It should be sprayed or dripped onto the rope where it is bent as it passes over the tip sheave. Wrap rags around the wire rope behind the sheave and swab the excess oil that is carried along on the rope. Always wear heavy leather gloves when handling wire rope.

IC-35 LUBRICATION CHART

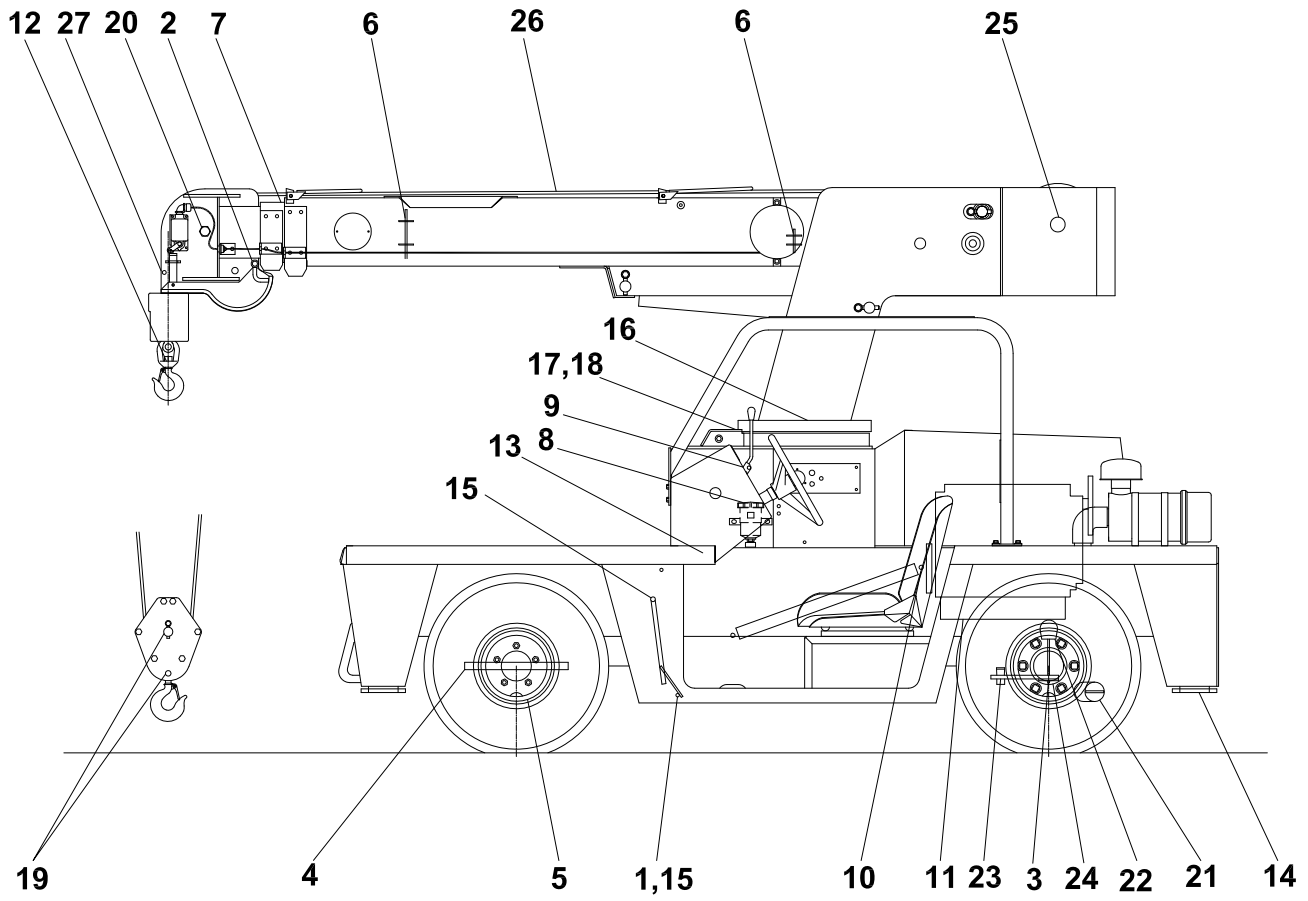

IC-35 LUBRICATION SCHEDULE

ITEM	DESCRIPTION	LUBE SYMBOL	LUBRICATION INTERVALS				MONTHS	NOTES
			50 HOUR	250 HOUR	500 HOUR	1000 HOUR		
1	Accelerator Linkage	SIL	X					2 Points (Not on E.F.I.)
2	Anti-Two-Block Arm	SIL	X					2 Points
3	Axle Kingpins	MPG			X			4 Zerks
4	Axle Pivot Pin	MPG			X			1 Zerk
5	Axle Planetary Hubs	MPL	X				12	Check @50, Change @12 Mo.*
6	Boom Extension Pins	MPG		X				6 Pins - Wipe
7	Boom Rub Pads	SIL	X					Spray or Wipe
8	Brakes	HO	X				12	Check @50, Change @12 Mo.*
9	Control Valve Links	SIL		X				12 Points
10	Driveshaft Joints	MPG			X			2 Zerks
11	Engine Oil	EO	X	X			6 Max.	Check Daily, Change @250 Hrs. or 6 Mo. Max.
12	Hook Swivel & Pin	MPG	X					Wipe
13	Hydraulic Oil	HO	X			X	12 Max.	Check Daily, Change @1000 Hours or 12 Mo. Max.
14	Outrigger Legs	SIL	X					Wipe Upper & Lower Sides
15	Pedal Hinges	SIL			X			2 Points
16	Rotation Bearing	MPG	X					1 Zerk*
17	Rotation Gearbox	MPL		X			12	Check @250, Change @12 Mo.
18	Rotation Gear Teeth	OGG	X					Brush On*
19	Sheave Block	MPG	X					2 Zerks
20	Sheave Pins	MPG	X					1 Zerk Std, 1 On Boom Ext.
21	Steering Cylinder Ends	MPG	X					2 Zerks
22	Steering Sector	MPG	X					1 Zerk
23	Steering Tie-Rod End	MPG	X					4 Zerks
24	Wheel Bearings, Rear	WBG					12	Clean & Repack
25	Winch(es)	MPL		X			12	Check @250, Change @12 Mo.
26	Wire Rope	2-X	X					Spray, Brush or Soak*
27	Wire Rope Retainers	SIL	X					

* See Procedures in the Manual

LUBE SYMBOLS

HO - Approved Hydraulic Fluids - See Page 3-21
 EO - Engine Oil - See Specs in Engine Manual
 MPG - Multi-Purpose Gun Grease
 MPL - Multi-Purpose Gear Lube - SAE 80W-90
 OGG - Open Gear Grease, Such as Mobilkote S
 SIL - Silicone Lube - Aerosol with Concentrating Tube
 WBG - Wheel Bearing Grease
 2-X - AMOVIS #2-x

FLUID VOLUMES

Brake Reservoir - 1 Pt.
 Engine Coolant - 3 Gal.
 Engine Oil (Nissan) - 1 Gal.
 Fuel Tank - 13.5 Gal.
 Hoist - 2 Pts.
 Hyd Tank - 14 Gal.
 Hyd System Total - 18 Gal.
 Torque Hubs Total - 2 Pts.
 Winch, Aux. Front - 8 Oz.

HOIST CABLE INSTALLATION AND INSPECTION

The following steps will assure that the wire rope winds smoothly and evenly on the hoist, and will yield greater safety and longer cable life:

Refer to **Section 1** of this manual for complete replacement rope specifications.

1. If possible, the cable should be rolled off a storage spool and straightened out on the ground in line with the boom. If the ground is not clean or the space is too limited, the cable can be wound directly from the storage spool onto the hoist, but the spool must rotate in the same direction as the hoist.
2. Check the seizings on the ends of the cable and replace them if they are missing or damaged.
3. Install the cable over the boom tip sheave and route it through the cable retainer loops to the hoist drum.
4. Position the hoist drum with the cable anchor on top.
5. Insert the cable through the anchor slot and wrap it around the anchor wedge. The end of the cable should extend past the wedge by about one inch.
6. Slide the cable and wedge into the drum socket and pull firmly on the free end of the cable to set the wedge. Seat the wedge securely with a brass or rawhide mallet.

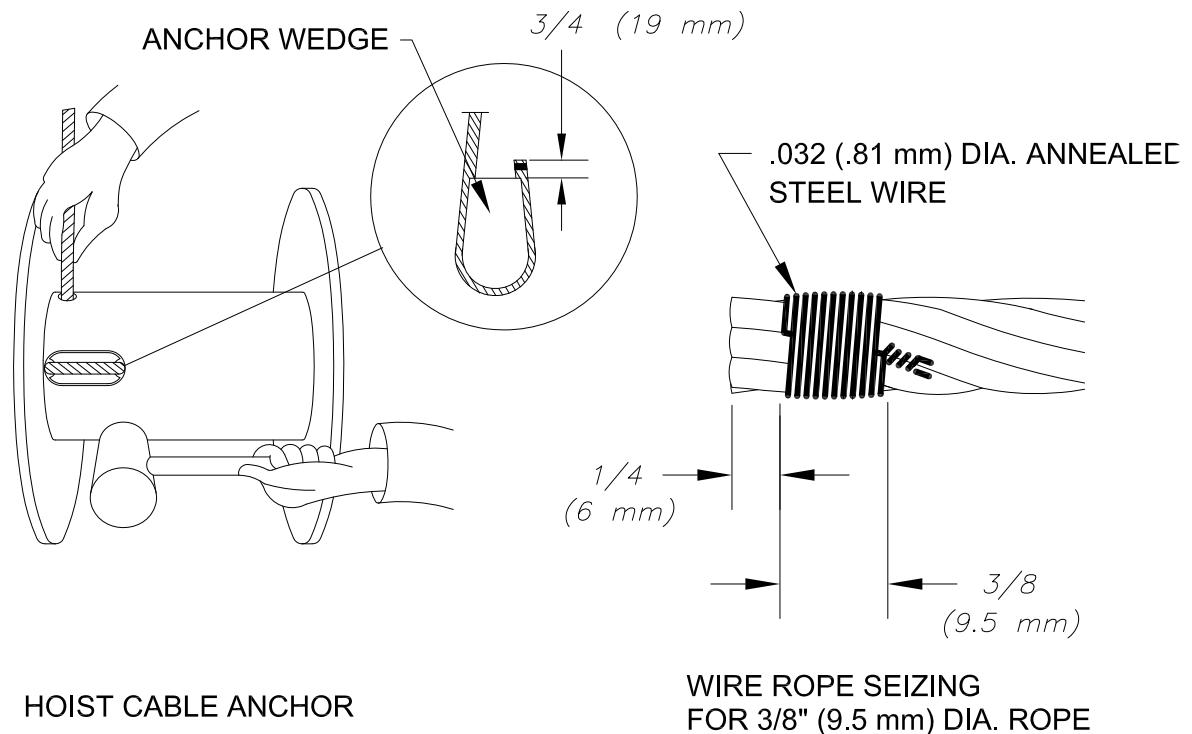

7. Slowly rotate the hoist while applying tension on the cable in front of the boom. Wear heavy leather gloves and wrap rags around the cable to wipe off any dirt from the cable. Keep hands away from the sheaves and hoist drum while the cable is moving.
8. After two turns of the hoist drum, stop the hoist and push the cable tightly against the flange of the drum with a wooden or rubber mallet.
9. Slowly rotate the drum until the first layer of cable is on the drum. If any gaps between the rope appear, stop the hoist and tap the cable toward the flange. There must be no gaps.
10. After the first layer is on the drum, the hoist may be turned a little faster until the remainder of the cable is installed.
11. Leave about 15 feet (5 m) of cable on the ground to install the sheave block. See the *Operation* Section for instructions on reeving and wedge socket attachment.
12. Install the cable retainer pins and cotters in the tip sheave plates.
13. For the cable break in, lower the outriggers and attach a load of about 1,000 pounds (500 kg). Extend the boom fully. Position the load at a 6-foot (2 m) load radius over the right-hand side of the crane. Hoist and lower the load three times and check winding of the rope on the hoist.
14. Attach about 3,000 pounds (1400 kg) and repeat. Be sure that the cable winds evenly on the hoist.
15. If the cable appears to twist too much, remove the sheave block and rewind the cable on the drum as in Steps 7-11.
16. Never lift more than the rated load on the Capacity Chart for the parts of line and type of wire rope being used.
17. Lubricate the cable as recommended in the *Wire Rope Lubrication* section. Inspect, maintain and replace the cable in accordance with ASME B30.5, Section 5-2.4.

JIC SCHEMATIC

IC-35-2G JIC SCHEMATIC

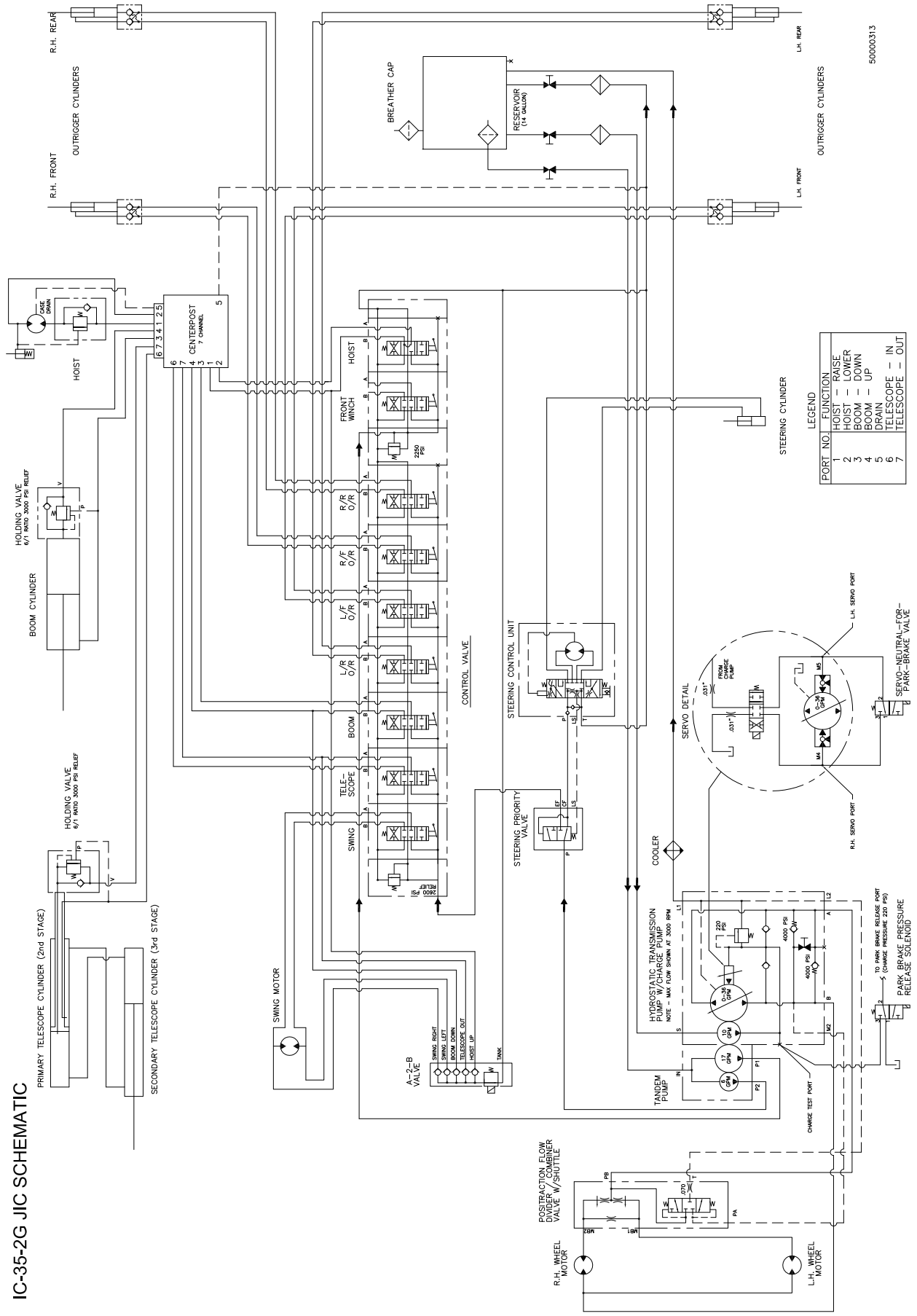

PORT NO.	FUNCTION
1	HOIST - RAISE
2	HOIST - LOWER
3	BOOM - DOWN
4	BOOM - UP
5	TELESCOPE - IN
6	TELESCOPE - OUT
7	

50000313

JIC SCHEMATIC METRIC

IC-35-2GCE JIC SCHEMATIC

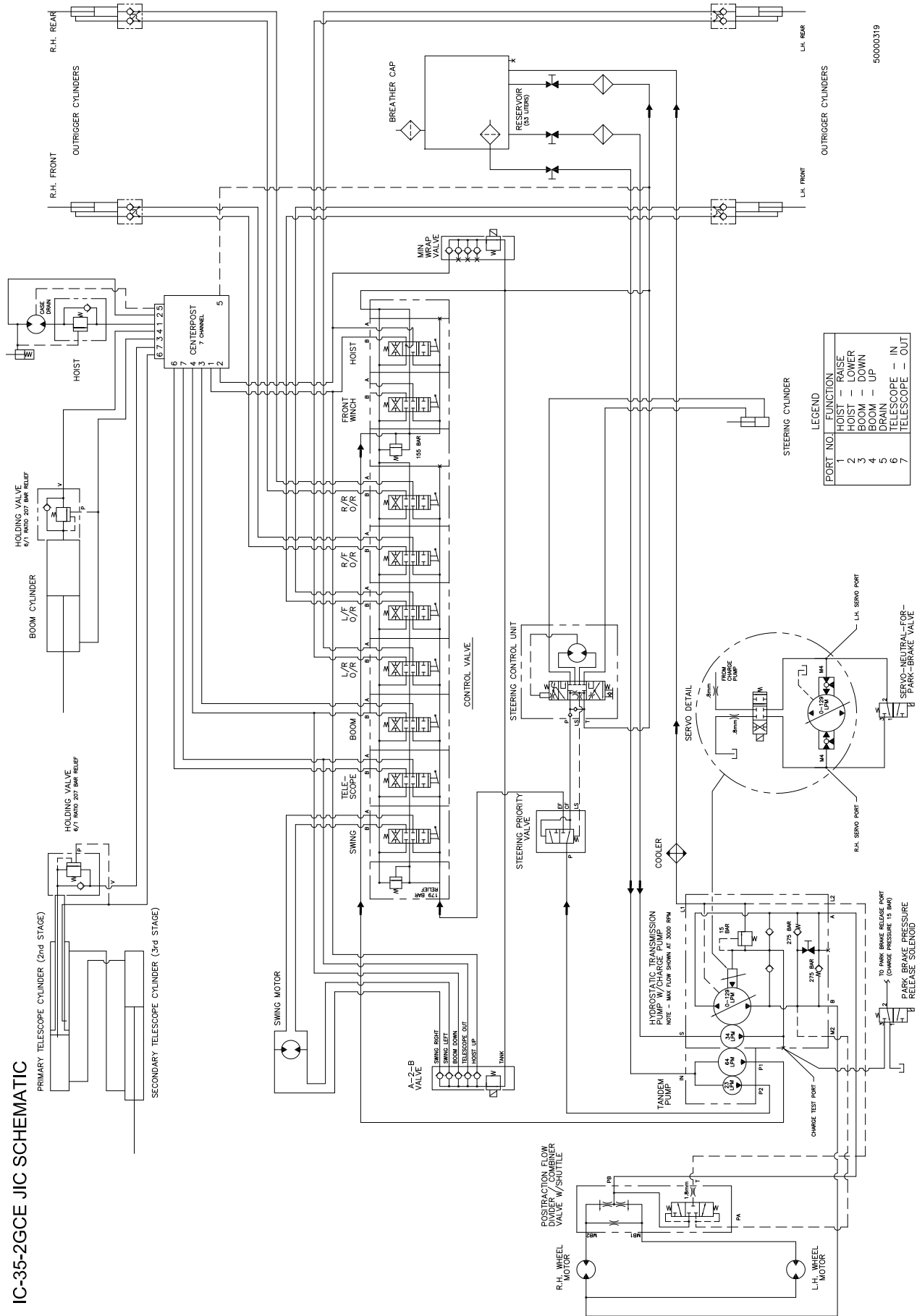

PORT NO.	FUNCTION
1	HOIST - RAISE
2	HOIST - LOWER
3	BOOM - DOWN
4	BOOM - UP
5	DRAIN
6	TELESCOPE - IN
7	TELESCOPE - OUT

50000319

HYDRAULIC SYSTEM

The IC-35 hydraulic system consists of three subsystems, driven by a triple pump. The 34 gpm (129 L/min) piston pump powers the propulsion system. The 6 gpm (23 L/min) gear pump supplies the hydrostatic steering function, and the boom and outrigger functions. The hoist and optional front winch are powered by the 17 gpm (64 L/min) pump.

The boom, outrigger and hoist functions are controlled by a single valve assembly with two inlet ports. The 6 gpm (23 L/min) pump flow enters the left-hand port and supplies the swing, boom, telescope and outrigger sections. The 17 gpm (64 L/min) pump flow enters the mid-inlet port to supply the hoist. Adjustment procedures for the crane hydraulic functions are given on page 3-27.

The schematic of the hydraulic system is shown on the page 3-13. The steering system and propulsion systems are also shown in diagrams on the following pages.

STEERING SYSTEM

The IC-35 steering system is a load-sensing, demand-type system that takes only as much flow as is needed when steering, and directs the excess flow to the control valve for boom and outrigger functions. The priority flow-control valve is in the line between the 6 gpm (23 L/min) pump section and control valve.

Oil from the 6 gpm (23 L/min) section of the pump goes into the priority valve at port "P." When no steering is required, the entire flow goes through the priority valve and leaves through port "EF" to the crane valve. The crane operating speed is not affected, since there is no loss of volume passing through the priority valve.

When the steering wheel is turned, the load-sensing line signals the priority valve to divert the required amount of oil to the steering control unit to meet the steering system requirements. The excess oil, not required for steering, flows to the crane control valve as usual. Since the amount of oil required for steering is usually a small portion of the pump output, the crane control valve is always operational while the unit is being steered. Crane operation speed is reduced such a slight amount, it is usually not noticed.

The steering control unit is non-load reactive. This means that bumps, curbs, and obstacles cannot change the steering angle and are not felt in the steering wheel. It also means that the wheels do not recenter when the steering wheel is released. The steering wheel must be turned back to center at the end of a turn.

There is a check valve in the pressure line between the priority valve and the steering control unit. This prevents pressure in the steering cylinders from venting back into the pressure line when the pressure is low. This eliminates steering wheel kickback when the steering wheel is released.

The steering system pressure relief valve inside the priority valve is set at 1250 PSI (86 bar) at the factory and should not need adjustment.

STEERING SYSTEM

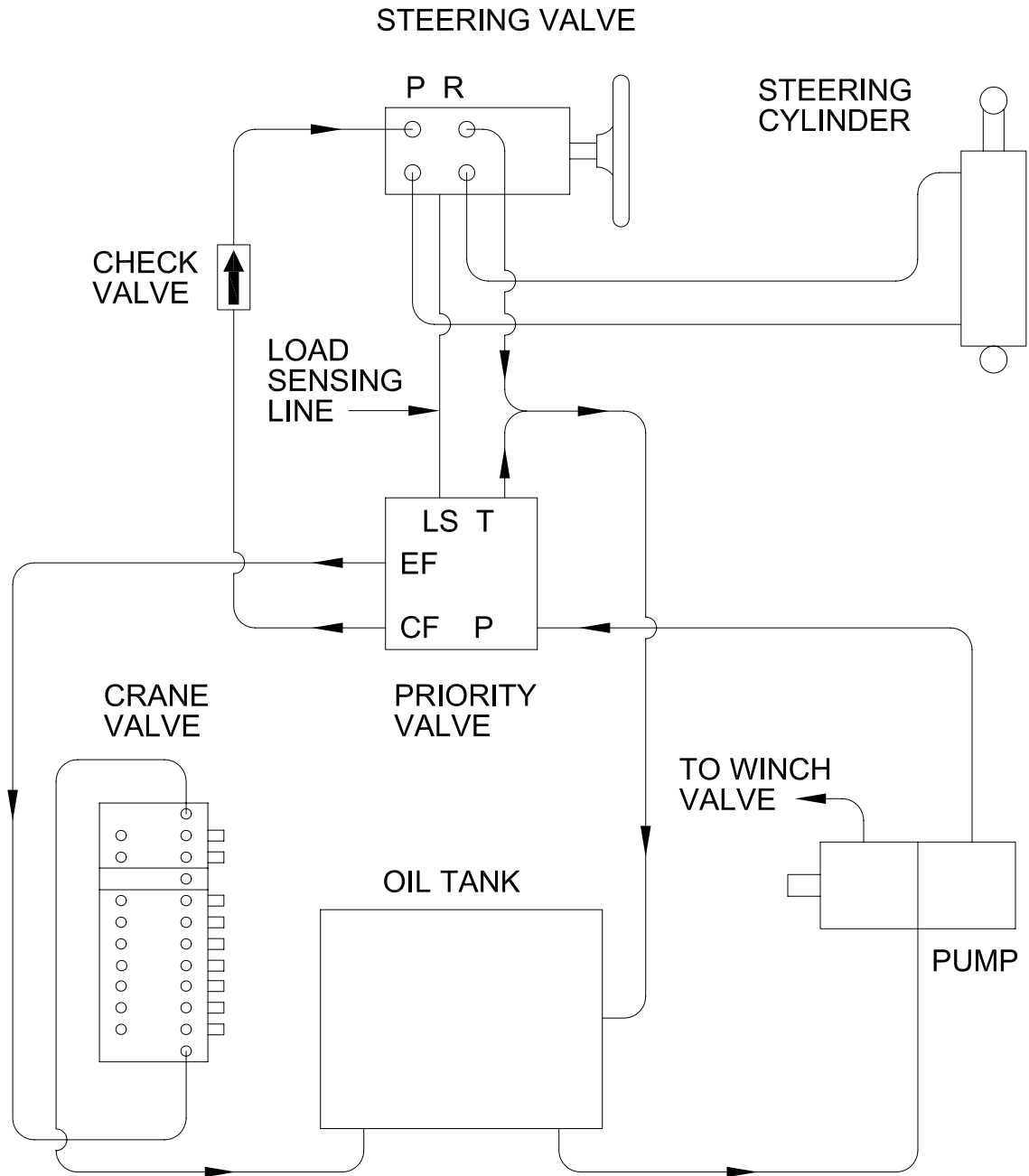

PROPULSION SYSTEM

The propulsion system is a closed-loop hydrostatic transmission. The variable volume piston pump is driveline driven from the engine crankshaft. The pump can deliver up to 34 gpm (129 L/min) or 4,000 PSI (276 bar) to the wheel drive motors. The flow from the wheel drive motors returns directly to the pump inlet, not the reservoir. The built-in charge pump maintains approximately 220 PSI (15 bar) of pressure to the intake side of the piston pump whenever the engine is running. Excess flow from the 9 gpm (34 L/min) charge pump combines with case drain flow and goes through the cooler and returns to tank.

When the transmission control switch in the operator compartment is in FORWARD, and the accelerator pedal is depressed, the pump starts delivering oil to the wheel drive motors for forward travel. When the accelerator is released, the pump blocks the flow and the wheel drive motors stop. If this is done on level ground, the crane will stop and stand still. If this is done on an incline, the crane will stop, but then creep down the incline, due to oil leaking through the wheel drive motors. ALWAYS apply the parking brake when the crane is stopped. When parking on a slope, also set the outriggers or place wheel chocks on the downhill side of the wheels.

A positraction flow divider is located in the line between the pump and drive motors. When a wheel is lifted off the ground, is on ice, or for any reason starts to spin, it will momentarily take more oil than the wheel that has traction. When this happens, a spool inside the positraction valve will shift and restrict the high flow to the spinning wheel, forcing flow to the wheel with traction. If the unit stops moving, the engine speed will have to be increased to resume travel.

The crane is equipped with an oil cooler that will allow it to operate properly when the ambient temperature is slightly over 100°F (38°C). An oil temperature gauge is provided just ahead of the steering wheel. The sensor for this gauge is located in the return line to the oil tank. If this gauge reads above 200°F (93°C), the unit should be shut down and the reason for the excessive temperature located and corrected. The fins on the oil cooler and engine radiator may be dirty and need cleaning.

The transmission speed is controlled by an electronic circuit that senses engine speed and signals the transmission pump to deliver a proportional flow of oil to the wheel drive motors. There is a manual operator lever on the control coil of the pump for testing.

A manual bypass valve is built into the piston pump. It appears like a shaft with a cross hole in it on the side of the pump. If the machine cannot run under its own power, it can be towed for very short distances at 5 mph (8 km/h) or less by turning the bypass valve counterclockwise 4 turns. It must be turned back again as far as possible to run normally.

CAUTION: The crane will roll freely down inclines with the bypass valve open. Keep the valve closed except when towing, and the crane is secured to the tow vehicle. An operator must be in the crane to operate the brakes.

IC-35 PROPULSION SYSTEM

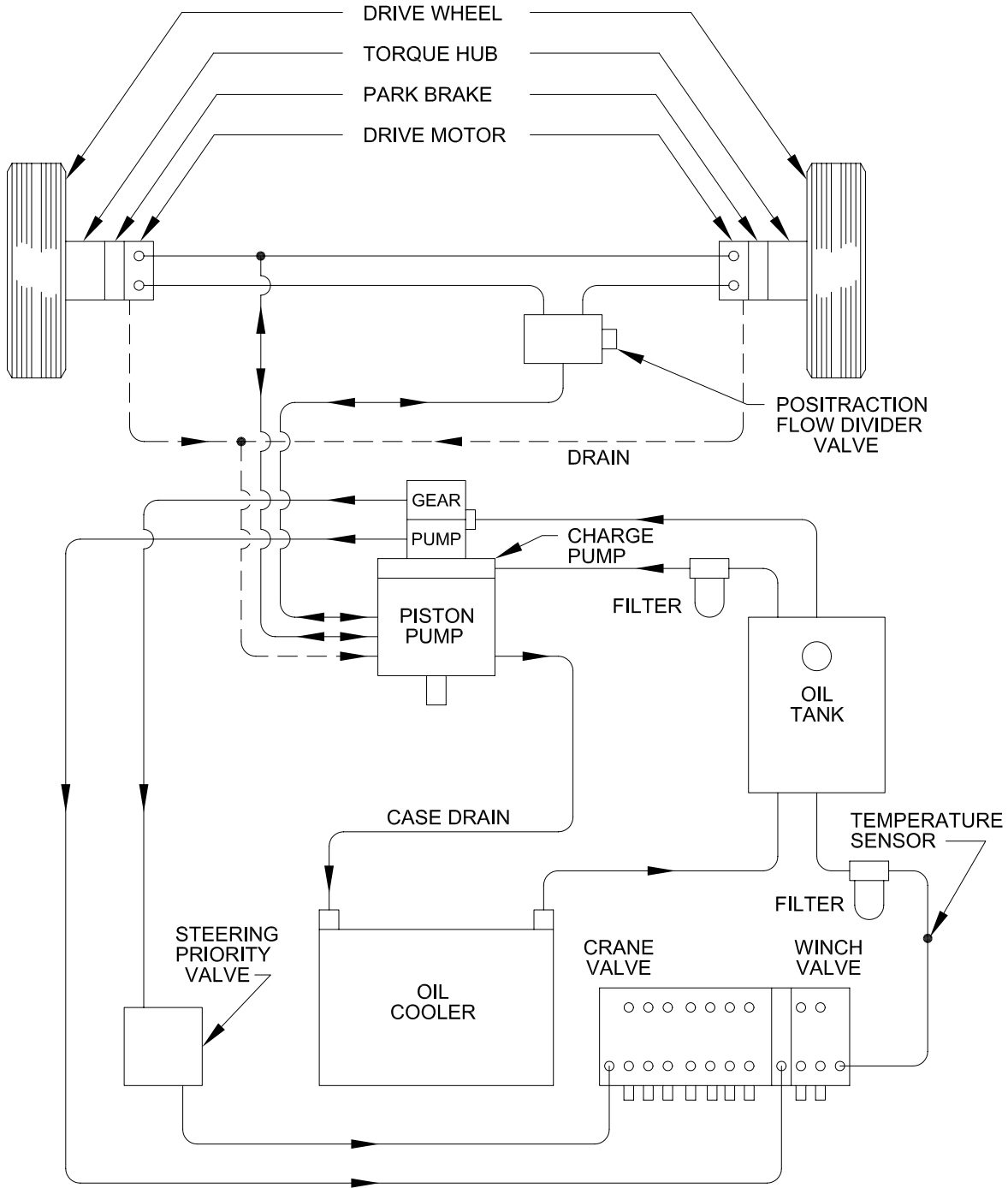

START-UP PROCEDURE -- PISTON PUMP

When initially starting a new or rebuilt transmission pump, it is extremely important that the start-up procedure be followed. It prevents damaging the unit that might occur if the system is not properly purged and charged with oil before start-up.

1. After the propulsion components have been properly installed, fill pump housing at least half full with new hydraulic fluid as specified on page 3-23. Connect all hydraulic lines and check to be sure they are tight.
2. Check the wiring connections to the pump control.
3. Fill the reservoir with approved hydraulic fluid that is new and clean. Install a 0 to 300 PSI (0 to 20 bar) gauge in the charge pressure port. The port is the highest port on top of the pump and has a #6 elbow with a ¼-inch hose that connects with the brake release valve. This may be disconnected, or a tee may be inserted. See figure below.
4. Gasoline or LP Engines: Remove the coil wire and turn the engine over for 15 seconds. Diesel Engines: Shut off the fuel flow to the injectors and turn the engine over for 15 seconds. This procedure enables the charge pump to pick up the oil before start-up.
5. Replace the coil wire or return the fuel flow to the injectors. Keep the transmission control switch in the neutral position, start the engine and run it at a low idle. The charge pump should immediately pick up oil and fill the system. If there is no indication of fill in 30 seconds (gauge in charge pressure port of the pump should register about 220 PSI (15 bar)), stop engine and determine the cause.

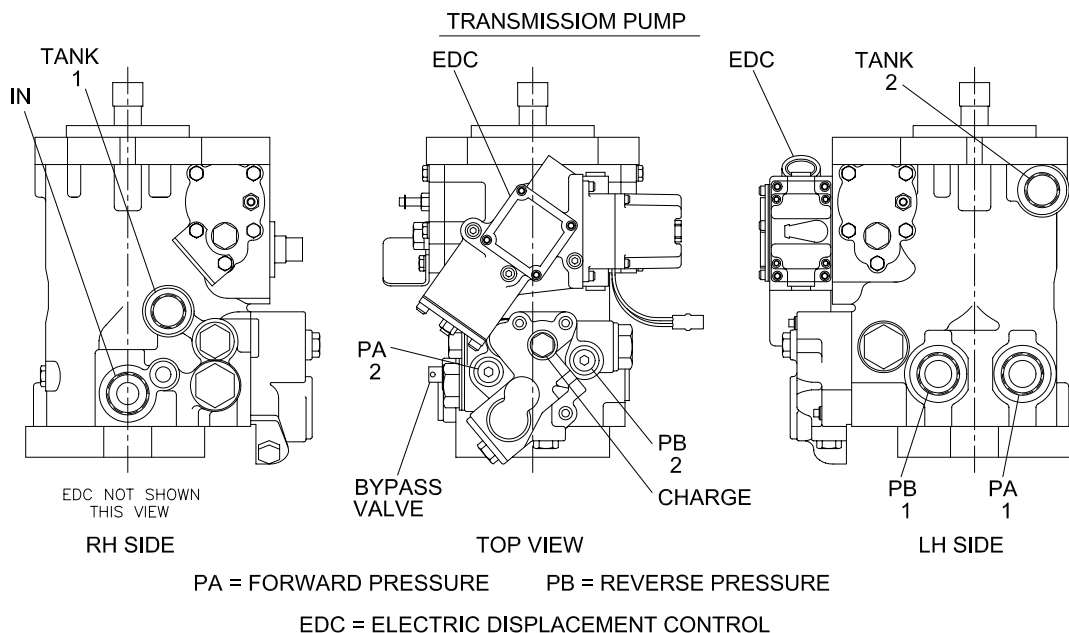

6. After the system shows signs of filling, run it in neutral and low idle for 5 minutes. Then extend the outriggers so that drive wheels can spin freely. Reconnect the brake release valve if disconnected in step 3. Place the control switch in the FORWARD position and slowly push the accelerator until the wheels turn slowly. Run for 5 minutes and repeat in REVERSE direction. Then increase to full throttle for one minute in each direction.
7. Check fluid level in the reservoir and fill to the proper level. Check all line connections for leaks and tighten if necessary.

IC-35 PISTON PUMP TROUBLESHOOTING

TROUBLE	CAUSES	REMEDIES
1. System will not operate in either direction.	A. Brake switch tripped	Release brake switch.
	B. Oil supply low	Check oil level, fill.
	C. Oil filter clogged	Replace filter element.
	D. Oil too heavy	Use proper viscosity oil.
	E. Bypass valve open	Close bypass valve.
	F. Bad electrical connection	Check all related connections.
	G. Circuit breaker open	Fix short, overload or breaker.
	H. Defective switch	Replace switch.
	I. Defective RPM sensor	Fix or replace sensor.
	J. Defective controller circuit	Replace controller circuit.
	K. Defective pump solenoid	Replace pump solenoid.
	L. Defective brake release solenoid	Fix or replace solenoid or wiring.
	M. Low charge pressure--below 200 PSI	See below: N, O, P, Q.
	N. Charge pump relief valve damaged	Remove relief valve parts. Examine parts and seat. Replace damaged parts.
	O. Damaged internal charge check valve	Disassemble and determine if check valve is faulty.
P. Charge pump key sheared	Inspect charge pump for damage & replace key.	
Q. Charge pump worn or scored or damaged	Remove parts and examine. Replace defective parts. If severe scoring is indicated, remove complete pump unit, disassemble and inspect for damage.*	
	R. Drive coupling broken	Inspect coupling for sheared spline.
	S. Forward or reverse relief valve stuck open	Remove relief valve. Clean or replace.
2. Pump is noisy.	A. Air in system	Fill oil reservoir. Check and fix suction line leaks.
	B. Clogged filter	Replace filter element.
	C. Internal pump or motor wear or damage	Disassemble, inspect and repair.*
3. Sluggish response to acceleration or deceleration	A. Air in system	See Steps 1-B, 1-D, 2-A.
	B. Low charge pressure	See Step 1-L.
	C. Loose bypass valve	Close bypass valve.
	D. Defective brake release solenoid	Fix or replace solenoid wiring.
	E. Internal pump or motor wear or damage	Disassemble, inspect, and repair.
	F. Reliefe valve dirty and damped	Remove, clean, and replace.

* Pump should be disassembled only by experienced hydraulic pump repair personnel, preferably at a Sundstrand Service Center.

CARE OF HYDRAULIC OIL

The hydraulic system contains many highly pressurized, precision components. To protect these, it is very important to keep the hydraulic oil clean, at proper temperature, within the oil specification, and to the proper fill level.

The IC-35 is equipped with a 100-mesh suction strainer, a 10-micron suction filter, a breather filter, a 10-micron, return-line filter and a 14-gallon (53 L) tank. The filters must be changed after the first 100 engine hours to eliminate the contaminants generated during run-in. Thereafter, they are to be changed at every 500 hour maintenance interval.

The filters are located under the deck cover. Clean the filter and the surrounding parts with steam or pressure washer before changing, to prevent dirt from falling into the clean oil tube. To minimize oil loss, close the shutoff valves under the tank. Be sure shutoff valves are fully opened before starting engine.

Remove the filter elements and catch the hydraulic oil in a clean container. Pour the remaining oil out of the old elements into the clean container and inspect the oil for water and excessive contaminants. If water is found, the oil should be changed in the reservoir and purged out of the cylinders. If excessive particles are found, the source should be located and fixed, and the oil should be purged.

Lubricate each new element seal and install the new elements. Open the shutoff valves. Run the engine and check for any leaking around the seals.

The hydraulic oil should be changed every 1000 hours or once a year, whichever is sooner. Wash the oil tank and filters before changing the oil. Retract the telescope, boom lift and outrigger cylinders. Leave the shutoff valves open and remove the drain plug. Catch the oil and dispose of it properly. Clean the breather element in the fill cap with solvent and compressed air. Clean out the tank with solvent and compressed air.

Replace the filters as described previously and refill the tank with new hydraulic oil that meets the specifications in the following table. Start the engine and run it at low idle for 15 minutes to filter the new oil. Then cycle all of the hydraulic cylinders at low idle and low pressure. Add hydraulic oil to the dipstick level mark, if necessary, with cylinders retracted.

APPROVED HYDRAULIC FLUIDS

WARM CLIMATE:

MOBIL AW-68
MOBIL DTE-26
CONOCO SUPER 68
TEXACO HD68

COOL CLIMATE:

MOBIL DTE-13/UNIV. ATF
TEXAMATIC TYPE F
PARADENE AW22
PRESSURFLO 22

CAUTION

Never add kerosene or other "thinners" to hydraulic oil. These fluids have low aniline points and consequently will cause rapid deterioration of certain packings and seals in the hydraulic system.

CAUTION

Serious damage to the pumps will result if they are run with the shutoff valves closed or with insufficient oil level in the reservoir.

Observe the operation of the machine. If the oil is too cold, the machine will be sluggish and should be warmed up further before sustained hard work is attempted. If the oil is too hot, leakage will increase, pump efficiency will go down, and moving parts will not be properly lubricated. If operating temperature is excessive, rapid deterioration of the oil will result and moving parts and seals will wear more quickly. The cause of the excess heat should be determined and corrected. Oil temperature should never exceed 200°F (93°C).

PURGING THE HYDRAULIC SYSTEM

If excessive water or other contamination is found in the hydraulic oil, the source should be found and fixed, and the oil should be changed. However, there will still be contaminated oil in the hydraulic cylinders. This oil should be purged by the following procedure:

1. Drain the reservoir, open the three gate valves under the reservoir and remove the two filter elements and the strainer.
2. Disconnect the following hoses: The four hoses at the reservoir, the return hose at the inlet of the smaller filter, the case drain hose at the hydrostatic transmission piston pump, the two pressure hoses at the double gear pump, and the two pressure hoses at the right-hand wheel motor.
3. Allow the oil to drain from the hoses and be careful to prevent dirt from getting in the hoses.
4. Blow out the oil cooler with compressed air, through the hoses attached to it.

5. Clean the reservoir and strainer, and replace the filter elements and hoses, except the return hose at the inlet of the smaller filter, and the case drain hose at the hydrostatic pump.
6. Attach a ¾-inch I.D. return hose at the hydrostatic pump case drain port and run it into a waste oil sump or barrel. Also run the return hose disconnected from the smaller filter into the waste oil sump or barrel. Do not plug these hoses.
7. Close the small gate valve under the reservoir and plug the case drain hose that is disconnected from the hydrostatic transmission pump. Leave the two large gate valves open.
8. Fill the reservoir with clean oil. Do not start the engine or move any controls until the proper point in this procedure. If the piston pump has been removed and replaced or repaired, follow the start-up procedure on page 3-19.
9. Monitor the oil level and do not allow it to fall below 5 inches (127 mm) from the top of the fill neck during this procedure.
10. Run the engine at low idle during this procedure to minimize oil loss and the possibility of pump damage from cavitation due to low oil level.
11. Start the engine and run at low idle for about 10 seconds after flow starts from both return lines into waste oil sump. This should purge the pressure and return lines. Stop the engine.
12. Remove the extra hose from the piston pump case drain, reconnect the regular case drain line and fill the reservoir.
13. Leave the return hose disconnected from the small filter and leave it in the waste oil sump.
14. Run the engine at low idle and turn the steering wheel fully to the right, then fully to the left, and then back to straight. Stop engine.
15. Be sure the outriggers are all clear. Push both outrigger levers fully forward and run engine until the outriggers are fully extended. Stop the engine.
16. Release the levers.
17. Reconnect the return hose. Fill the reservoir and be sure all shutoff valves are open. Run the engine at low idle for 15 minutes to filter the oil.
18. With the front wheels off the ground, set the transmission control switch to FORWARD and push the accelerator slowly until both wheels are turning slowly.
19. Run both wheels slowly, for 5 minutes. Then switch to REVERSE and run both wheels slowly in reverse for 5 minutes. Run the wheels at full speed in both directions for 1 minute.

20. Position the crane so that the boom may later be fully topped up, rotated and extended. Do not operate these functions until the proper step.
21. Close the small gate valve in the return line and disconnect the return hose from the return filter inlet again. Run the hose into the waste oil sump. Shutoff valves in the suction lines must be open.
22. Pull the BOOM RAISE lever fully back in the raise position and start the engine. Run at low idle until the boom is fully topped up, then stop engine quickly.
23. Pull the SWING lever fully. Run the engine for 3 seconds and stop engine.
24. Release SWING lever, push HOIST lever to full LOWER position and run engine for 7 seconds, then stop engine.
25. Fill hydraulic reservoir.
26. Remove the hook from the load line and pull load line out of the boom tip.
27. Push TELESCOPE lever fully forward in the EXTEND position. Run the engine until the boom extends fully, then stop engine.
28. Reconnect the return hose. Be sure all shutoff valves are open.
29. Retract the boom and fill the reservoir.
30. Run engine and cycle all of the cylinders in and out several times.

BLEEDING THE BRAKES

The brake module on the end of each torque hub has a pedal-operated function and a spring-applied pressure released parking brake. Each portion has a bleed screw on the module. The upper bleed screw is for the pedal-operated system and the lower one is for the pressure-released system. A system should be bled whenever a line in that system has been disconnected.

To bleed the pressure-released section, run the engine to pressurize it and slowly loosen the lower bleed screw until oil flows from the bleed screw. Be careful to avoid oil spraying into your face or other parts of your body. After air has escaped, close the bleed screw and repeat on the other side of the axle. Test brake for proper release.

To bleed the pedal-operated section, depress pedal and open the upper bleed screw. Close the screw and allow pedal to return. Repeat on each brake until pedal is firm. Apply brakes firmly four times and repeat the process once more. Keep reservoir full of hydraulic oil during bleeding.

Once a year bleed the pedal-operated brakes to force new oil into the brake lines and cavities.

HYDRAULIC SEALS

WARNING

Do not check for hydraulic leaks with hands. If a mist of hydraulic oil is noticed around a line or component, use cardboard or other material to check for location of leak. High pressure fluid leaking from a small hole, can be almost invisible, yet have enough force to penetrate the skin. If injured by escaping fluid, see a doctor at once. Serious reaction or infection can occur.

All hydraulic fittings and hose connections should be kept tight to prevent loss of fluid from the system and unnecessary dripping from the machine. Most hydraulic fittings on the IC-35 crane use o-ring seals, and if tightening the fitting fails to stop the leak, the o-ring should be replaced.

Notes:

1. When installing an o-ring fitting with an adjustable nut and washer, be sure to back off the nut, washer and o-ring as far as possible before threading the fitting into the port. Then turn the fitting into the port as far as possible with fingers and turn it backward until it is oriented properly. Torque the nut with a wrench, while holding the fitting with a wrench.
2. Lubricate all seals before assembling.
3. Take care not to over tighten pipe threads.
4. Do not use Teflon tape to seal pipe treads. Loctite-type (anaerobic) sealant is preferred.

Leaks in component parts, such as pumps, valves and motors, that cannot be stopped by tightening bolts, can usually be stopped by replacing the seals in the component. Seal and packing replacement is the only maintenance which owners should attempt on component parts, unless they have a well-equipped shop with mechanics trained in hydraulic component overhaul.

Leakage in the pump suction line may not cause oil to appear externally, but may allow air to enter the line during operation. The air entrained in the oil will cause pumps to be noisy, and if allowed to continue, can damage the pump. If a pump becomes noisy, immediately check the fluid level in the reservoir and be sure all suction fittings are tight. If noise continues, squirt hydraulic fluid on the suction connections. Listen for a change in the noise and watch for oil being sucked into a small opening in the connection. When the reservoir is full, the shutoff valve is open and all suction connections are tight, most pump noises will disappear. If they do not, a worn or faulty pump is indicated. On a routine basis, all hoses should be checked for wear, deterioration, and physical damage. Defective hoses should be replaced for maximum economy for the user.

CONTROL VALVE ADJUSTMENTS

The crane control valve has two relief valves to protect the hydraulic components. The relief valves are adjustable and should be checked and set as follows:

1. Boom and outrigger circuits 2,600 PSI (179 bar) at full flow.
2. Hoist circuit 2,250 PSI (155 bar) at full flow.

BOOM AND OUTRIGGER CIRCUITS:

Remove the 3/8-inch tube cap from the test fitting on the left-hand side of the control valve and install a 3,000 PSI (200 bar) test gauge. To obtain full flow reading, run pump at full speed and actuate BOOM control lever to LOWER position, and hold until maximum reading is made. If a pressure of 2,600 PSI (179 bar) is not possible, check the following:

1. Low oil level in the reservoir.
2. Clogged suction filter or shut-off valve not fully opened.
3. Valve spool linkage not allowing control valve to fully open. Valve spool should move 5/16-inch (8 mm) each way from neutral.
4. Adjust relief valve by removing cap on end of relief cartridge, and turning socket head screw clockwise to increase pressure or counter-clockwise to lower pressure.
5. Foreign particle in pilot-operated relief.
6. Broken mechanical connection to the pump shaft.
7. Worn or defective hydraulic pump.

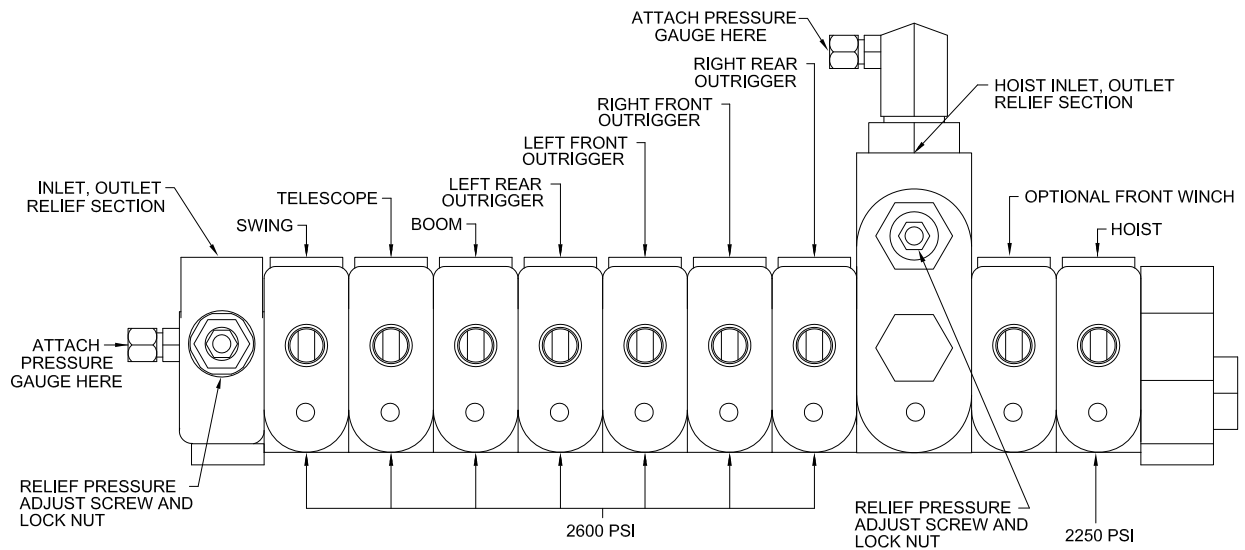

HOIST CIRCUIT:

The relief pressure for the hoist valve can be adjusted similarly to the boom circuit. Connect a 3,000 PSI (200 bar) gauge to the test fitting on the mid-inlet section of the valve. Disconnect both hoses at hoist motor and install plugs. Do not connect hoses together. Operate hoist control in either direction. Run engine at full throttle. Adjust relief valve to 2250 PSI (155 bar) at full flow.

BOOM CYLINDER HOLDING VALVE

A holding valve is built into the base of the boom lift cylinder barrel. This valve is designed to hold the boom in position should loss of power or pressure line failure occur.

To check the boom lift cylinder holding valve, set the outriggers, place the boom in the horizontal position over the front of the crane and raise rated load about one foot above the ground using the boom lift cylinder (not the hoist). An example of rated load for the IC-35-2G is 4,150 pounds (1830 kg) at an 8-foot (2.5 m) load radius, with outriggers extended and the boom over the front. Turn the engine off and move the BOOM lever to the LOWER position. If the boom moves down, adjust the holding valve.

WARNING

Before working on the holding valves or plumbing to the boom cylinders, always relieve trapped pressure by lowering the boom fully, turning off the engine, and cycling the BOOM and TELESCOPE lever.

To adjust the holding valve, loosen the jam nut on the adjusting screw and turn the screw counterclockwise one-half turn and retest. Repeat until unpowered boom movement stops. Retighten the jam nuts. If adjusting the valve does not help, the cylinder may have internal leakage or the valve may be malfunctioning.

EXTENSION CYLINDER HOLDING VALVE

A holding valve is directly connected to the base of the primary extension cylinder rod. The valve is designed to hold the boom in position should loss of power or pressure line failure occur.

The holding valve should be checked with the boom elevated to the maximum angle and the boom extended to a 4-foot (1.2 m) load radius. An 8,000-pound (3630 kg) load on a two-part line is required for this test. Use the hoist to lift this load about 6 inches above the ground. The radius of the test load should be within the rating on the capacity chart. Use great care to prevent the load from hitting the crane.

Turn the engine off and pull the TELESCOPE lever to the RETRACT position. If the boom retracts, the valve should be adjusted.

To adjust the holding valve, loosen the lock nut on the adjusting screw and turn the screw clockwise until unpowered movement stops. Retighten the lock nut to hold the proper adjustment.

ENGINE MAINTENANCE

AIR CLEANER SERVICE:

Clean out the dust cup every 50 hours. Loosen the clamps around the cup and housing and remove the cup. Dump dust out of cup. Clean gasket and sealing surfaces with a damp cloth. Replace cup gasket if it shows signs of damage. Replace cup with arrows pointing up and tighten clamp.

Clean the intake cap screen every 50 hours, and perform a thorough inspection of the air intake pipes and joints.

Clean the filter element every 250 hours or every 3 months, whichever comes sooner and replace the element every 500 hours or 6 months. Remove and clean the dust cup and gasket, and the intake cap. Remove the wing nut on the element and gently remove the element. Bumping the element during removal may cause dirt to fall into the clean air tube. Clean the inside of the housing carefully with a damp cloth. To clean the element, use a compressed air blower nozzle with less than 100 PSI (7 bar) and blow air from the inside of the element. Shake dust off of the outside of the element. Make sure the gaskets and element fit properly and reassemble, being careful not to allow any dust into the intake pipe.

Do not remove an element just for inspection. This may do more harm than good. You cannot judge the element condition by its appearance. If you think the filter may need service, remove it and replace or clean it before reassembling air cleaner.

Conditions where more dirt than usual is in the air, especially soot, will make more frequent service necessary. If there is a significant amount of dust in the dust cup when it is cleaned every 50 hours, clean the element every 100 hours and replace it every 200 hours--or more frequently in extremely dusty conditions. Excessive exhaust smoke or loss of power may indicate a plugged filter.

COOLING SYSTEM:

Check the level of coolant in the radiator overflow tank daily. Add a mixture of antifreeze and distilled water to the overflow tank, as required, to maintain the coolant level. Check the radiator fins for dirt or debris daily and wash the fins with a pressure or steam cleaner every 50 hours, or as required. Check the antifreeze protection level every 500 hours. Every two years, flush the cooling system and replace the thermostat and coolant. Pressure test the system as specified by the engine manufacturer.

SPARE PARTS LIST:

A spare parts list (including oil filter, fuel filter, etc.) may be found in the Parts Manual under *Engine Installation*. Replace engine parts only with genuine OEM parts as required by EPA regulations.

MAJOR ENGINE SERVICING OR OVERHAUL:

Major servicing or overhaul is beyond the scope of this manual. Consult authorized engine service manual or rely on an authorized engine service center.

MECHANICAL ADJUSTMENTS

FASTENERS:

All fasteners in the IC-35 should be checked, and retightened if required, as a part of the preventive maintenance program. Particular attention should be given to the axle, wheel and hub mounting bolts, pump mounting bolts, rotation bearing bolts, rotation gearbox bolts and hoist bolts. All bolts used in assembly are heat-treated Grade 5, except the bolts attaching the rotation bearing to the mainframe and turret, which are Grade 8 socket heads. The torque chart on the next page can be used on all bolts.

ROTATION GEARBOX:

The rotation gearbox assembly is attached to the chassis top plate by four capscrews. It is held in proper engagement with the external teeth on the bull gear by two jackscrews in front of the gearbox. It is further restrained from torsional movement by four bolts at the sides of the gearbox. Proper adjustment exists when there is .010-inch (0.254 mm) backlash between the pinion and bull gear teeth. If adjustment is required, loosen the gearbox mounting bolts and the side bolts. Tighten the two front jackscrews until proper adjustment is obtained. Tighten the mounting bolts and the side bolts. Lock jackscrews and bolts into position.



WHEEL BEARING ADJUSTMENTS:

Wheel bearing adjustment must be maintained at all times. Adjustment is made each time the bearings are repacked (annually). Wheel bearings are adjusted by the adjusting nut. This nut should be tightened until only a slight drag is felt when rotating the wheel.

WHEEL ALIGNMENT:

Toe-in, which is the setting of the steering wheels so they are closer together at the front than at the rear, is adjusted by lengthening or shortening the tie rods. Proper toe-in for the rear wheels is zero.

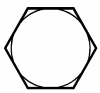
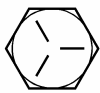
TORQUE DATA

BOLT GRADE	SAE GRADE 1 OR 2	SAE GRADE 5	SAE GRADE 8
MARKING			
MATERIAL	LOW CARBON	MEDIUM CARBON STEEL Q & T	MEDIUM CARBON ALLOY STEEL Q & T
MINIMUM TENSILE STRENGTH	64,000 PSI (441 MPa)	120,000 PSI (827 MPa)	150,000 PSI (1034 MPa)
BOLT SIZE	RECOMMENDED TORQUE VALUES FT-LBS (N·m)		
1/4	5 (6,7)	7 (9,5)	10.5 (14)
5/16	9 (12)	14 (19)	22 (30)
3/8	15 (20)	25 (34)	37 (50)
7/16	24 (32,5)	40 (54)	60 (81)
1/2	37 (50)	60 (81)	92 (125)
9/16	53 (72)	88 (119)	132 (179)
5/8	74 (100)	120 (163)	180 (244)
3/4	120 (163)	200 (271)	296 (401)
7/8	190 (258)	302 (409)	473 (641)
1	282 (382)	466 (632)	714 (968)



THE FOLLOWING RULES APPLY TO THE CHART:

1. Consult manufacturers' specific recommendations when available.
2. The chart may be used with coarse and fine thread fasteners lightly lubricated.
3. Increase torque by 20% when multiple tooth (shakeproof) lockwashers are used.
4. The torque values are given in foot-pounds (N·m).
5. Inch-pounds equivalent may be obtained by multiplying by 12

IC-35-2G WIRING DIAGRAM (GAS)

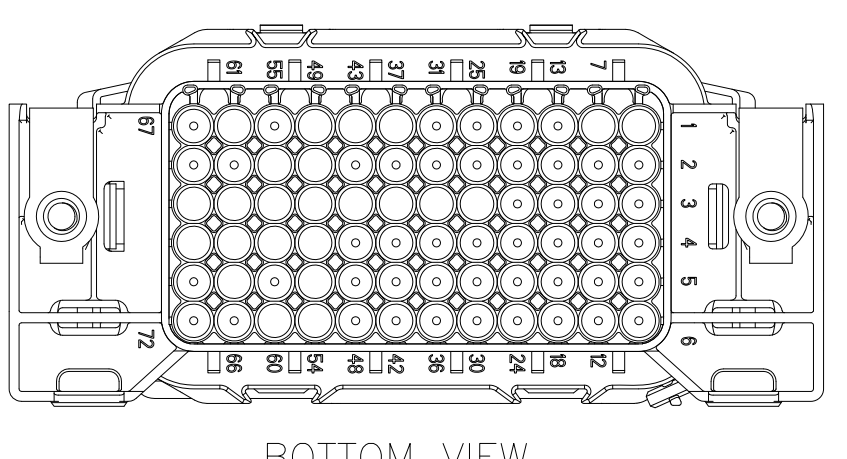
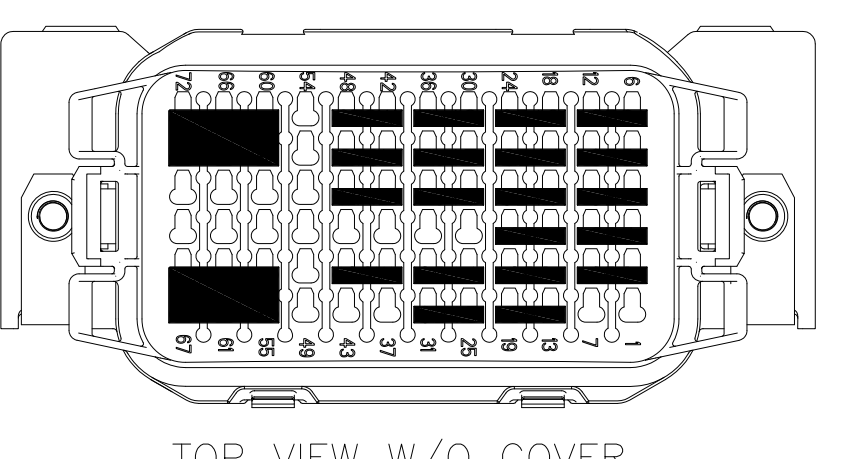
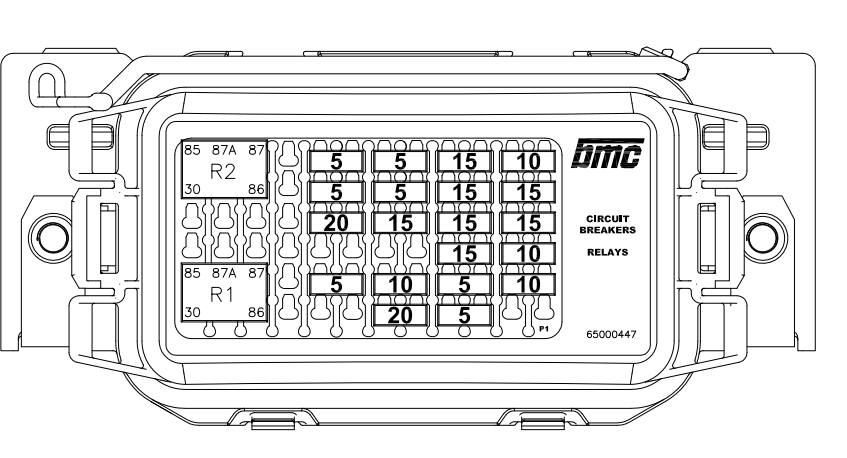
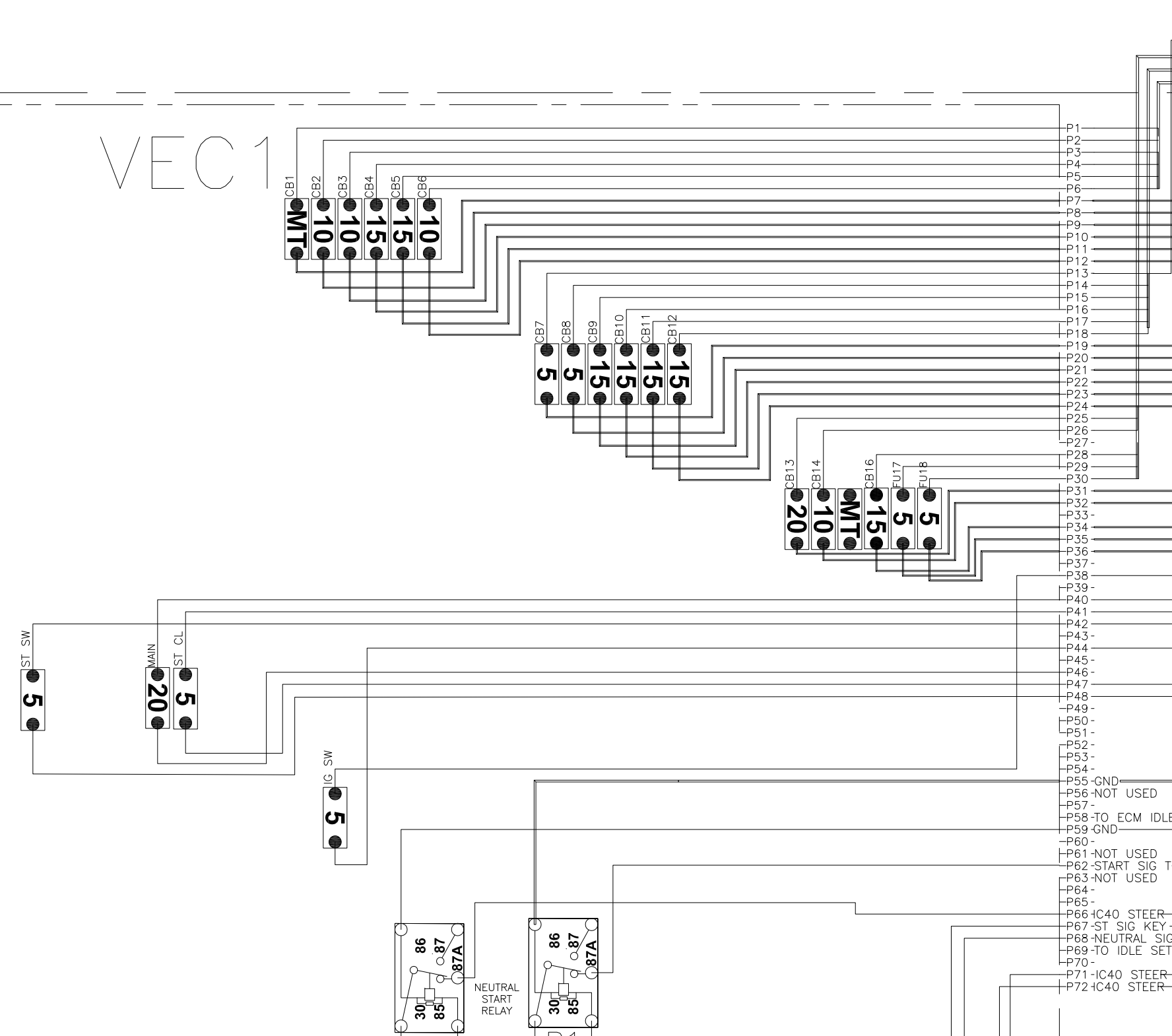
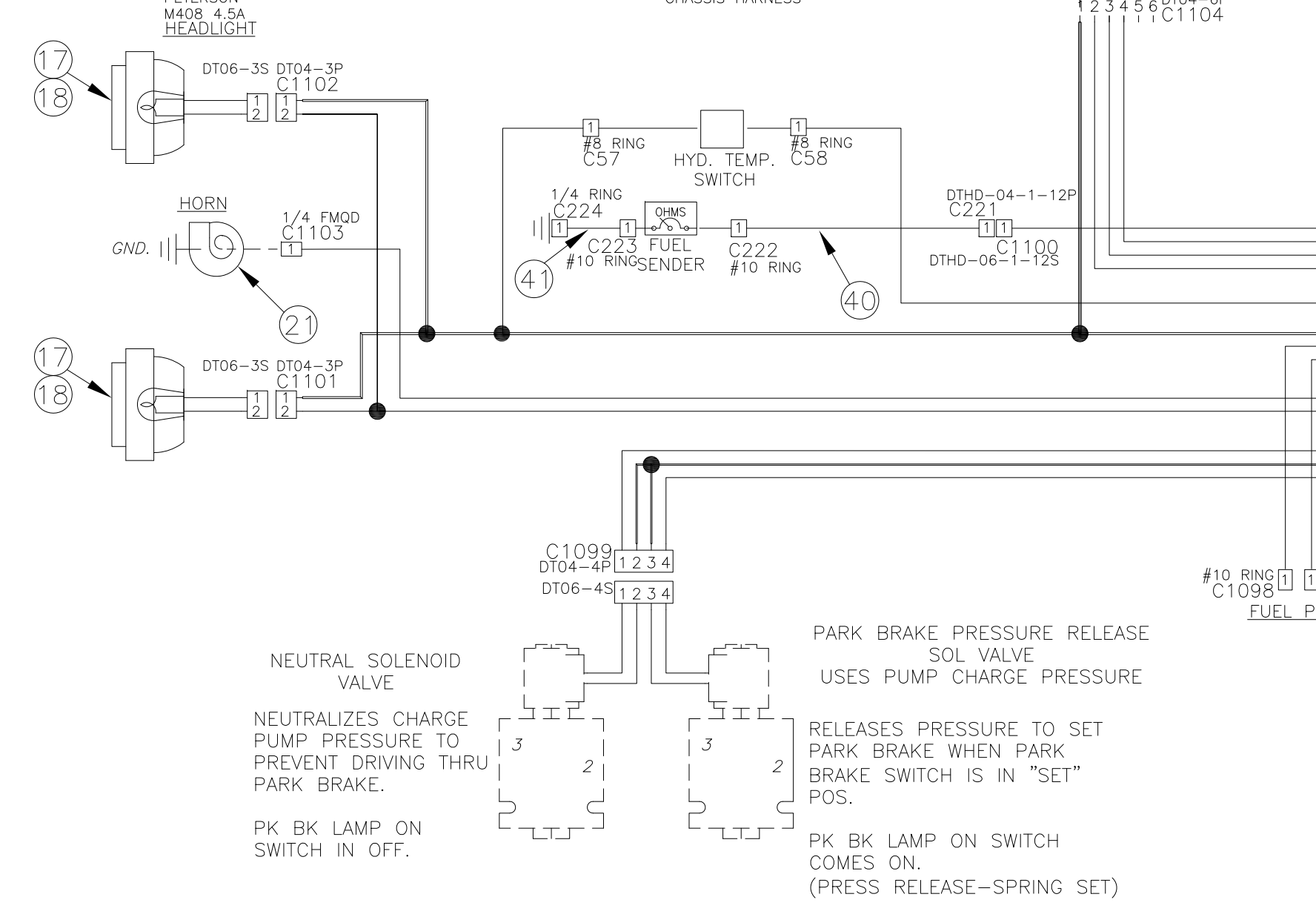
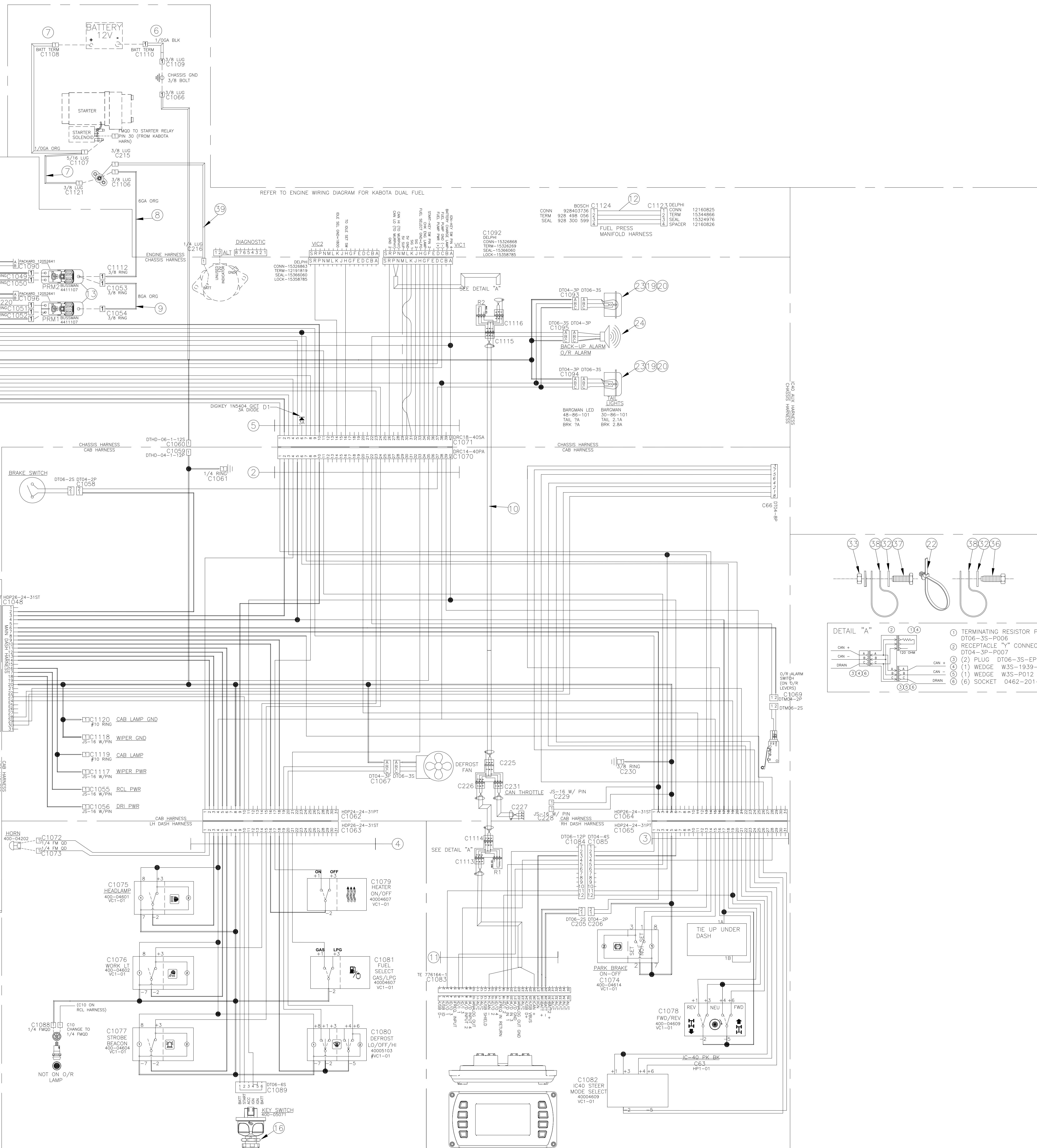
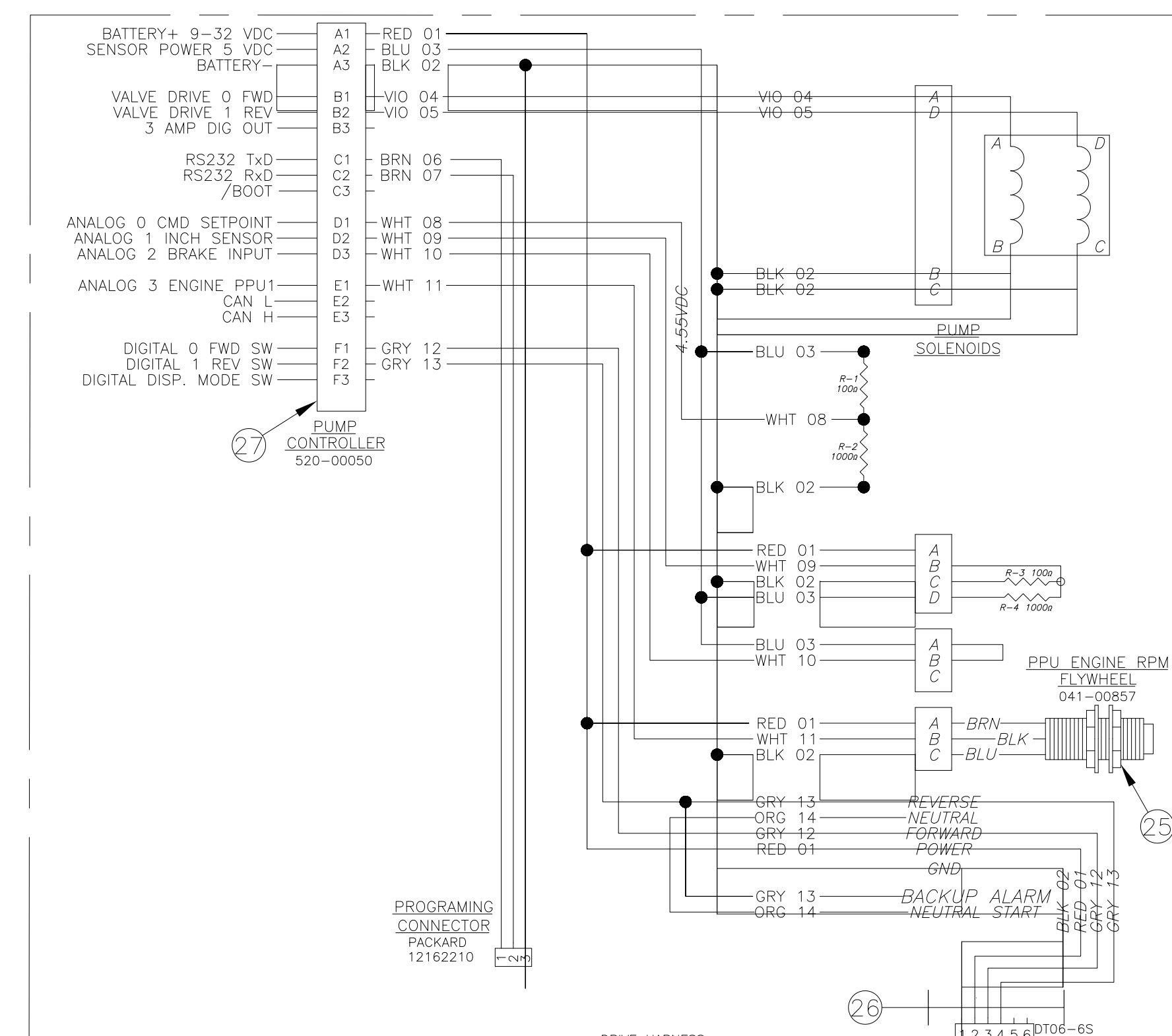

TYPE	POS	AMP	CIRCUIT FUNCTION
	1		MT
CB	2	10	BRAKE SWITCH (LAMPS)
CB	3	10	PARK BRAKE SOLENOIDS
CB	4	15	FWD/REV SW
CB	5	15	12V TO ECM
CB	6	10	BACKUP ALARM
CB	7	5	MURPHY DISPLAY POWER
CB	8	5	CHK/STOP END LAMP PWR
CB	9	15	DEFROST FAN
CB	10	15	HEATER FAN
CB	11	15	STROBE/BEACON
CB	12	15	WORK LIGHTS
CB	13	20	HEADLAMPS/MARKERS
CB	14	10	HORN
FU	15		MT
FU	16	15	WIPER/CAB LT
FU	17	5	RCL POWER
FU	18	5	DIR POWER
FU	19		MT
STSW	20	5	START SWITCH
	21		MT
STCL	22	5	START COIL
MAIN	23	20	MAIN SWITCH
IGNW	24	5	IGNITION SWITCH

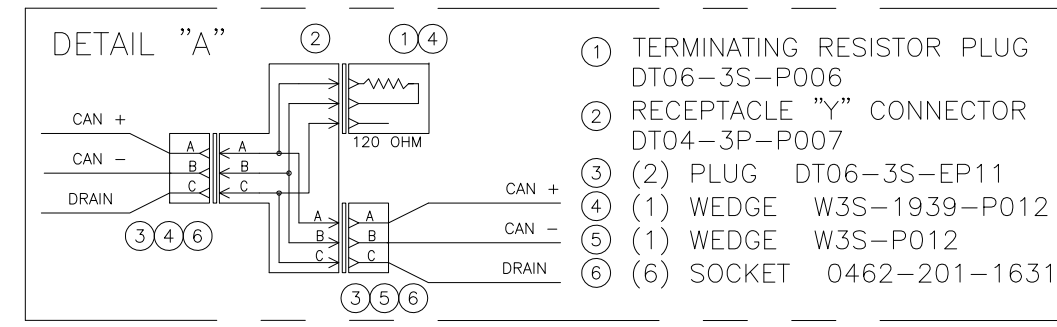

IC-35-2G WIRING DIAGRAM (DIESEL)

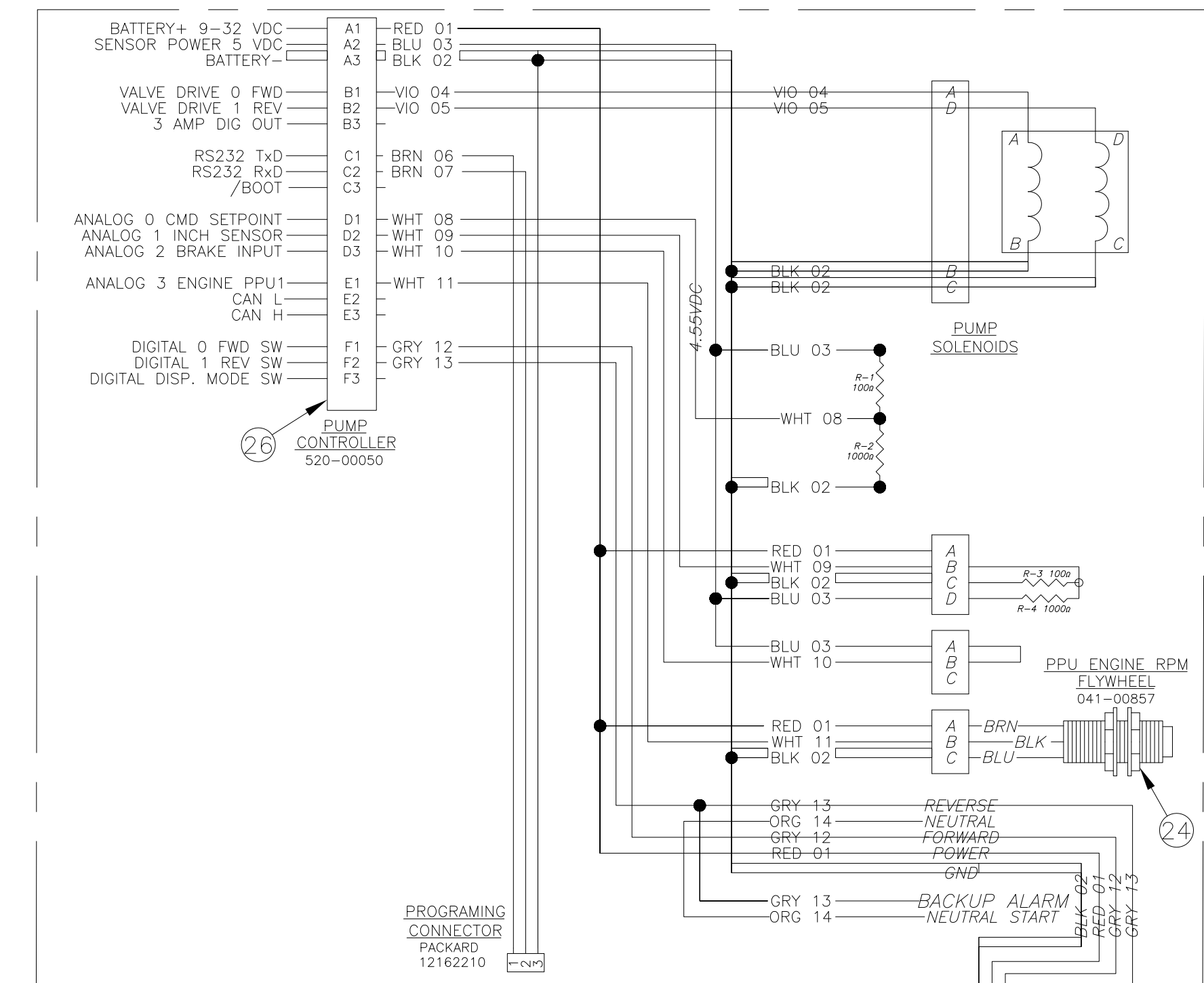
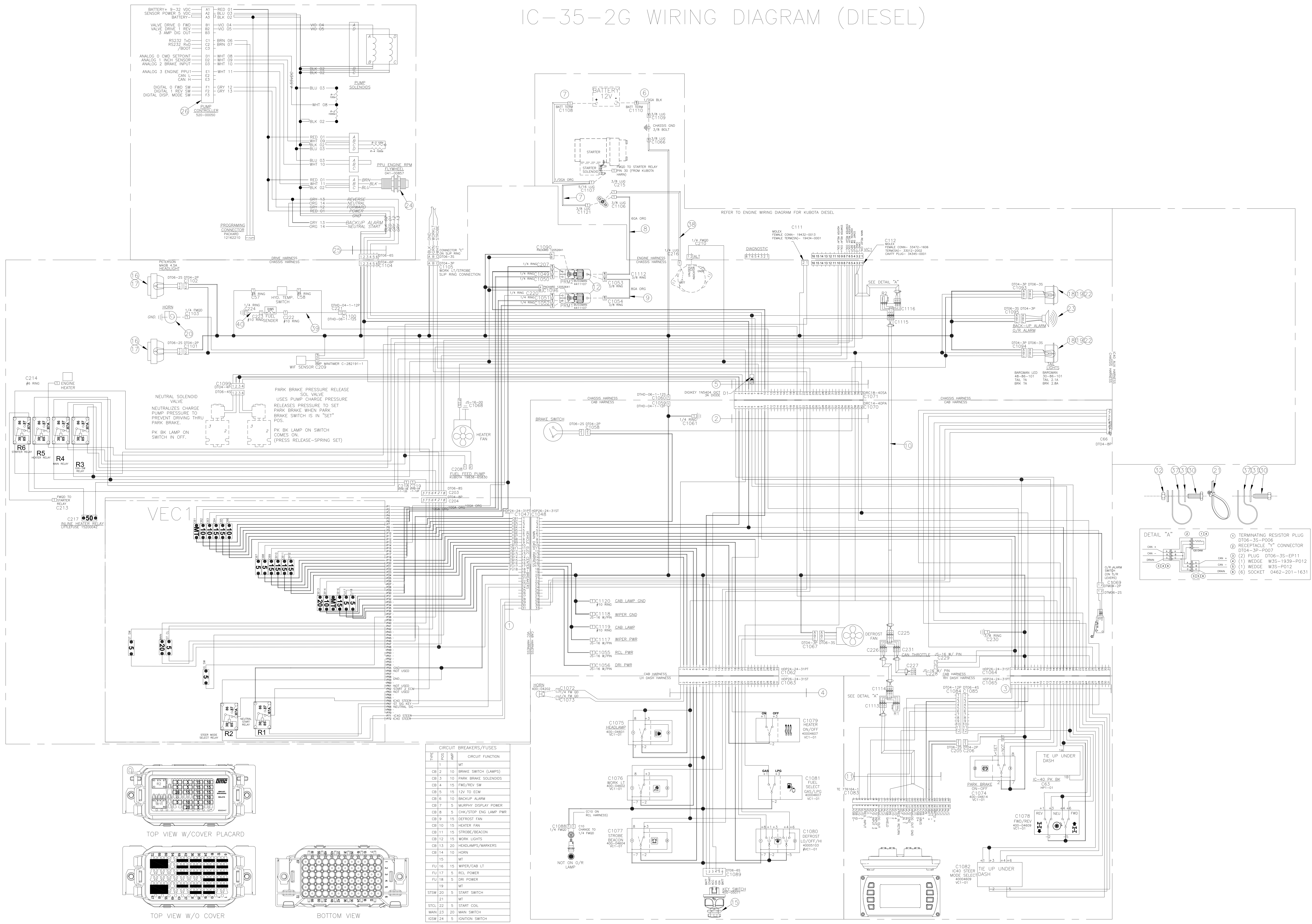

CIRCUIT BREAKERS/FUSES

TYPE	WGS	AMP	CIRCUIT FUNCTION
1	MT		
CB 2	10		BRAKE SWITCH (LAMPS)
CB 3	10		PARK BRAKE SOLENOIDS
CB 4	15		FWD/REV SW
CB 5	15		12V TO ECM
CB 6	10		BACKUP ALARM
CB 7	5		MURPHY DISPLAY POWER
CB 8	5		CHK/STOP ENG LAMP PWR
CB 9	15		DEFROST FAN
CB 10	15		HEATER FAN
CB 11	15		STROBE/BEACON
CB 12	15		WORK LIGHTS
CB 13	20		HEADLAMPS/MARKERS
CB 14	10		HORN
15	MT		
FU 16	15		WPPER/CAB LT
FU 17	5		RCL POWER
FU 18	5		DRI POWER
19	MT		
STSW 20	5		START SWITCH
21	MT		
STCL 22	5		START SOIL
MAN 23	20		MARK SWITCH
IGSW 24	5		IGNITION SWITCH

