

PRINTED IN USA
P/N 990-30227

COPYRIGHT© 2017
BRODERSON MFG. CORP.
LENEXA, KANSAS 66215

OPERATION AND MAINTENANCE MANUAL IC-40-D

OWNER: _____

SOLD AND SERVICED BY: _____

MODEL NO. _____ SERIAL NO. _____

BRODERSON MANUFACTURING CORP.

STATEMENT OF WARRANTY FOR MOBILE CRANES

Broderson Manufacturing Corp. ("BMC") warrants its products to be free from defects in material or workmanship at the date of shipment from BMC. This warranty shall be effective only when validated by the return to BMC of its standard form of Warranty Validation Certificate (Attachment A), duly completed and signed by the original purchaser from BMC and any subsequent purchaser who buys a BMC product as a new product, and then only as to defects reported to BMC in writing within 1 year or 2000 hours, whichever occurs first, from the date a product is placed in service, as evidenced by such warranty validation certificate. **THIS WARRANTY APPLIES TO ALL PARTS OF BMC'S PRODUCTS EXCEPT ENGINES, DRIVE TRAINS, HYDRAULIC SYSTEM COMPONENTS, TIRES, OR ACCESSORY EQUIPMENT, WITH RESPECT TO WHICH BMC MAKES NO WARRANTY OF MERCHANTABILITY OR FITNESS FOR A PARTICULAR PURPOSE AND NO OTHER WARRANTY OF ANY KIND, EXPRESS OR IMPLIED;** the sole warranties, if any, with respect thereto being those made by the respective manufacturers thereof.

THE SOLE REMEDY FOR BREACH BY BMC OF THIS WARRANTY SHALL BE THE REPLACEMENT OF ANY PARTS OF ITS PRODUCTS WHICH WERE DEFECTIVE AT THE DATE OF SHIPMENT OR, IF (AND ONLY IF) REPLACEMENT OF DEFECTIVE PARTS IS IMPOSSIBLE OR IS DEEMED BY BMC TO BE IMPRACTICAL, REPLACEMENT OF THE ENTIRE PRODUCT OR, AT BMC'S OPTION, REFUND OF THE PURCHASE PRICE. The replacement remedies include labor in connection with the removal of defective parts and the installation of their replacements, as well as the cost of delivery and transportation of defective products or parts and the replacements thereof. The sole purpose of these remedies is to provide the purchaser with free replacement of defective parts or, in the limited circumstances specified, replacement of the entire product or a refund of the purchase price. These exclusive remedies shall not be deemed to have failed of their essential purpose so long as BMC is willing and able to replace defective parts or the entire product or to refund the purchase price. The remedies herein provided shall be available only if BMC is given reasonable access to the product, including all allegedly defective parts, promptly after the defect is discovered. BMC shall have the right to return any allegedly defective parts to its plant or any other location selected by it, for inspection and testing to determine whether they were defective at the date of shipment, prior to replacement thereof.

The warranty herein made is extended only to the original purchaser from BMC and any subsequent purchaser who buys a BMC product as a new product. **WITHOUT LIMITING THE GENERALITY OF THE FOREGOING, BMC EXPRESSLY DISCLAIMS THAT THE WARRANTY MADE HEREIN EXTENDS TO A PERSON WHO RENTS OR LEASES ANY BMC PRODUCT OR WHO PURCHASES ANY BMC PRODUCT AS A USED PRODUCT.** For purposes hereof, a BMC product shall conclusively be deemed "used" after the expiration of twelve (12) months from its placement in service, as evidenced by a duly completed and signed warranty validation certificate actually received by Broderson, or after such earlier time as it has been operated for more than one hundred (100) hours. This warranty shall not apply to ordinary wear and tear; negligence; acts of God; vandalism; abuse; misuse; neglect; accident or causes beyond the reasonable control of BMC, including without limitation fires, freezing, floods and other natural disasters; overloading; unauthorized altered, modified or changed products or parts; products or parts that have been improperly adjusted; or the Purchaser's neglect, negligence or willful damage; any products or parts not provided by BMC; any products or parts which have been repaired outside of BMC or an authorized distributor facility ; unless authorized in writing by BMC; or damages caused by failure to follow the maintenance procedures outlined in the applicable service manual or in technical bulletins issued by BMC.

BMC does not warrant any of its products to meet any state, local or municipal law, ordinance, code, rule or regulation. The purchaser must assume the responsibility for maintaining and operating the products which are the subject of this warranty in compliance with such of the foregoing as may be applicable, and BMC shall not be liable for the purchaser's failure to meet such responsibility.

THE WARRANTY HEREIN MADE IS IN LIEU OF ANY OTHER WARRANTY, EXPRESS OR IMPLIED. BMC MAKES NO WARRANTY OF MERCHANTABILITY OR FITNESS FOR A PARTICULAR PURPOSE, OR ANY OTHER EXPRESS OR IMPLIED WARRANTY OF ANY KIND, TO ANY PURCHASER, LESSEE OR RENTER OF NEW OR USED BMC PRODUCTS OR ANY OTHER PERSON WHATSOEVER. NO PERSON IS AUTHORIZED TO ACT ON BEHALF OF BMC IN MODIFYING THE WARRANTY HEREIN MADE OR IN MAKING ANY ADDITIONAL OR OTHER WARRANTY.

IN NO EVENT SHALL BMC BE LIABLE FOR INCIDENTAL OR CONSEQUENTIAL DAMAGES OF ANY KIND WHATSOEVER. THIS EXCLUSION OF INCIDENTAL AND CONSEQUENTIAL DAMAGES IS INTENDED TO BE INDEPENDENT OF ALL OTHER PROVISIONS OF THIS STATEMENT OF WARRANTY AND SHALL BE GIVEN FULL EFFECT NOTWITHSTANDING THE UNENFORCEABILITY OR FAILURE OF THE ESSENTIAL PURPOSE OF ANY OTHER PROVISION OF THIS STATEMENT OF WARRANTY.

THE FOREGOING DISCLAIMERS OF WARRANTIES AND DISCLAIMER OF LIABILITY FOR INCIDENTAL OR CONSEQUENTIAL DAMAGES SHALL BE EFFECTIVE REGARDLESS OF WHETHER THE EXPRESS WARRANTY CONTAINED HEREIN BECOMES EFFECTIVE AS PROVIDED IN THE FIRST PARAGRAPH HEREOF.

TABLE OF CONTENTS

SECTION 1	DESCRIPTION and SPECIFICATIONS	
	Introduction.....	1-1
	Dimensions and Orientation IC-40-2D.....	1-2
	Turning Dimensions IC-40-2D.....	1-3
	Description and Specifications.....	1-4
SECTION 2	OPERATION	
	Safety Rules.....	2-1
	Instruments and Controls.....	2-8
	Control Functions.....	2-9
	3-Mode-Steering Functions.....	2-9
	Sequence of Operation.....	2-10
	Driving the Vehicle.....	2-10
	Operating the Crane.....	2-11
	Normal Gauge Readings.....	2-11
	Rated Capacity Limiter.....	2-12
	Crane Capacity.....	2-13
	Crane Capacity Chart Definitions and Rules.....	2-14
	Crane Capacity Example.....	2-15
	Crane Capacity Chart IC-40-2D.....	2-16
	Crane Capacity Chart IC-40-2D Metric.....	2-17
	Sheave Block and Downhaul.....	2-18
	Two-Part-Line Reeving.....	2-19
	Safety Devices.....	2-20
	Optional Equipment Operation.....	2-21
	Boom Extension.....	2-21
	Front Auxiliary Winch.....	2-22
	Capacity Example for Boom Extension.....	2-23
	Pintle Hooks.....	2-24
	Switch Indicator Symbols.....	2-25
SECTION 3	MAINTENANCE	
	Safety Rules.....	3-1
	Inspection and Testing Checklists.....	3-3
	Maintenance Checklist.....	3-5
	Lubrication.....	3-7
	Rotation Bearing.....	3-7
	Torque Hub Lubrication.....	3-7
	Wire Rope.....	3-7
	Lubrication Chart and Schedule.....	3-8
	Hoist Cable Installation and Inspection.....	3-10
	Hydraulic System Description.....	3-14
	JIC Schematic.....	3-12
	JIC Schematic Metric.....	3-13
	Steering System.....	3-14
	Propulsion System.....	3-16

SECTION 3 MAINTENANCE (continued)

Hydraulic System Maintenance.....	3-18
Transmission Start-Up Procedure.....	3-18
Transmission Troubleshooting.....	3-19
Care of Hydraulic Oil.....	3-20
Hydraulic Oil Specifications.....	3-21
Purging the Hydraulic System.....	3-21
Hydraulic Seals.....	3-24
Hydraulic System Adjustments.....	3-25
Control Valves.....	3-25
Boom Cylinder Holding Valve.....	3-26
Extension Cylinder Holding Valve.....	3-26
Engine Maintenance.....	3-27
Air Cleaner Service.....	3-27
Cooling System.....	3-27
Spare Parts List.....	3-27
Major Engine Servicing.....	3-27
Mechanical Adjustments.....	3-28
Fasteners.....	3-28
Rotation Gearbox.....	3-28
Wheel Bearings.....	3-28
Wheel Alignment.....	3-28
Torque Data.....	3-29

BRODERSON MANUFACTURING CORP.

IC-40-2D INDUSTRIAL CRANE

INTRODUCTION

The Broderson IC-40-2D was designed and built to provide safe, dependable, and efficient crane service. This we assure by our testing and quality control procedures. To properly utilize the full potential of the equipment, the following customer controlled conditions must exist:

1. The operator must understand the equipment.
2. The operator must know the operating characteristics.
3. The operator must observe the safety rules.
4. The equipment must be given proper maintenance.

This manual was written to provide information required for these conditions. The recommendations for periodic inspection, test, and maintenance are minimum standards for safe and economical performance.

When ordering parts: the unit serial number, unit model number, part number, part description, and quantity must be provided.

This unit must not be altered or modified without written factory approval.

To reorder this manual, ask for IC-40-2D Operation and Maintenance Manual Part Number 99030227. Contact your Broderson service representative at:

Broderson Manufacturing Corp.
14741 W. 106th St.
Lenexa, Kansas 66215 USA
913-888-0606

NOTICE

If this crane becomes involved in an accident, please call Broderson Manufacturing Corp. at 913-888-0606, and ask for the Legal Department or the Service Manager. Also, please notify your Broderson dealer.

DIMENSIONS AND ORIENTATION IC-40-2D

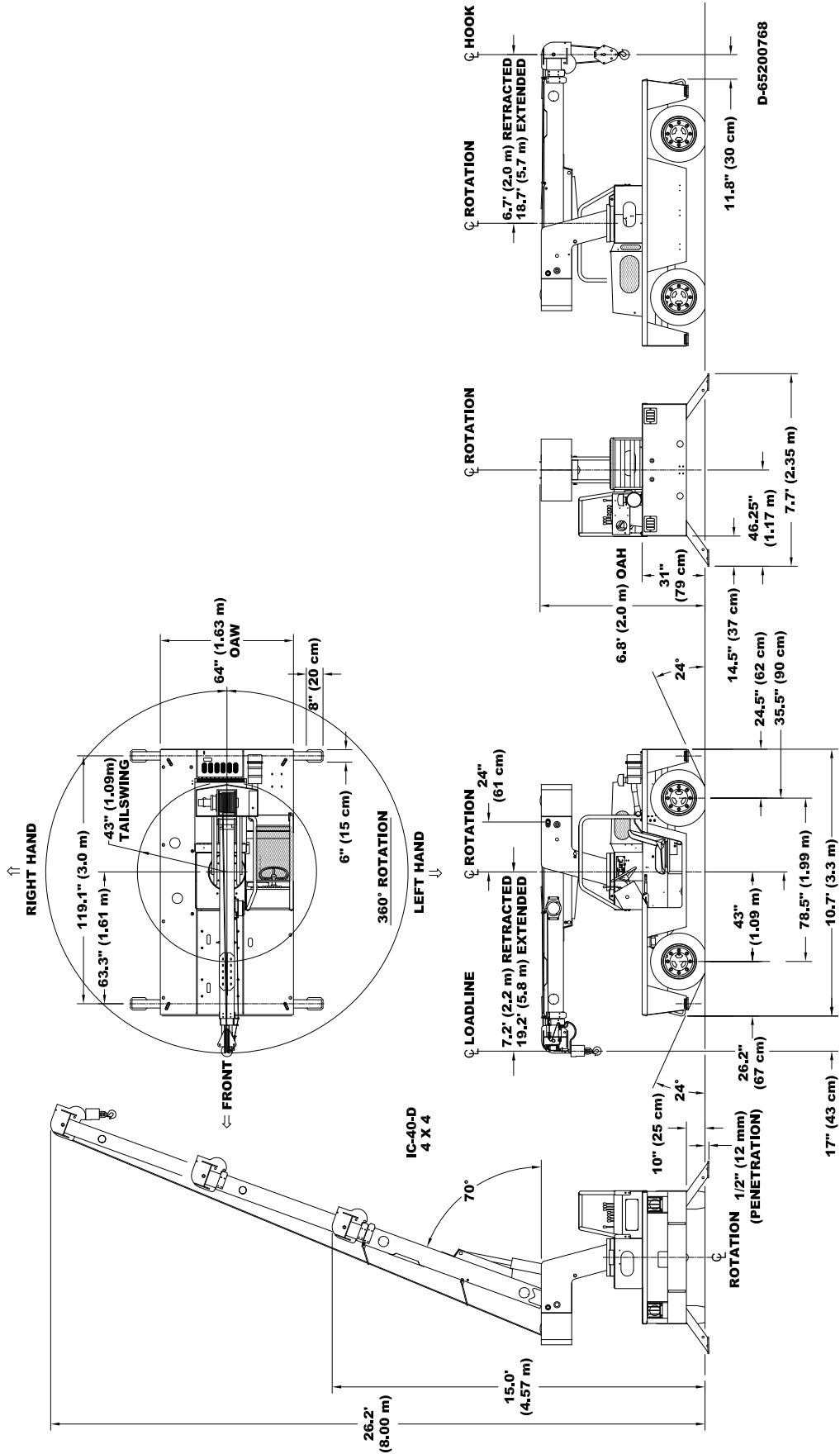

TURNING DIMENSIONS

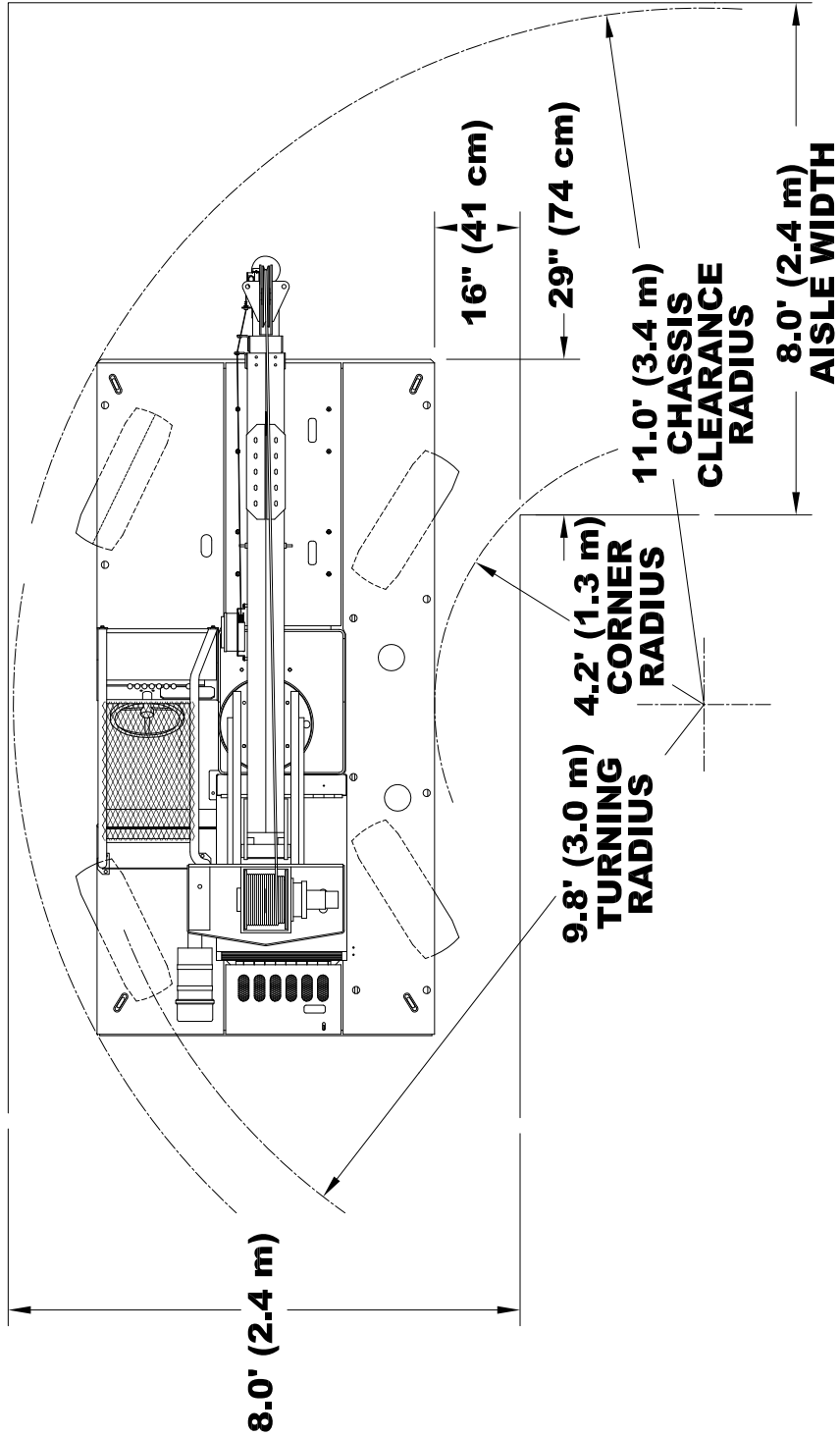

SECTION 1

DESCRIPTION AND SPECIFICATIONS

BMC's IC-40-2D is a self-propelled, industrial crane designed for in-plant lifting and material handling applications. It has the special features of low height, narrow width, short length, cargo deck, four-wheel steer, and four-wheel drive. The basic unit consists of a chassis and a hydraulic boom assembly. The chassis includes a frame, four hydraulic outriggers, an engine, a variable speed, hydrostatic transmission, and two drive axles with power steering. The boom assembly includes a hydraulic-powered continuous rotation turret, a three-section telescopic boom, a hydraulic boom-elevating cylinder, hydraulic boom extension cylinders, and a hydraulic-powered hoist. A Rated Capacity Limiter is standard.

IC-40-2D:

This model includes a 3-section hydraulically extended boom with capacity of 9,000 pounds (4080 kg) at a 4-foot (1.2 m) load radius. It has a horizontal reach of 19.2 feet (5.8 m), and a vertical reach of 26.2 feet (8.0 m). Hoist is located on back of turret.

GENERAL:

Length:	
Chassis	10.7 feet (3.3 m)
Overall	12.2 feet (3.7 m)
Width:	64 inches (1.63 m)
Height:	
Deck	31 inches (79 cm)
Overall	6.8 feet (2.0 m)
Wheelbase:	78.5 inches (1.99 m)
Ground Clearance:	
Chassis	10 inches (25 cm)
Minimum (Axle)	8 inches (20 cm)
Angle of Approach:	24 °
Angle of Departure:	24°
Turning Radius: (Minimum)	9.8 feet (3.0 m)
Aisle Width: 90° Turn (Min.)	8.0 feet (2.4 m)
Travel Speed: (Max.)	10 MPH (16 km/h)
Outriggers:	
Spread	7.7 feet (2.35 m)
Penetration	0.5 inches (12 mm)

Weight Distribution: (Base Machine)	
Front Axle	4210 pounds (1910 kg)
Rear Axle	4710 pounds (2140 kg)
Total	8920 pounds (4050 kg)
Tire Footprint Area:	40 square inches (260 cm ²), each
Outrigger Footprint Area:	48 square inches (310 cm ²), each
Drawbar Pull:	2000 pounds (910 kg)
Gradeability:	24% (13°)
<i>Calculations based on gasoline engine.</i>	
Grade Limit:	15 %
Boom Movement:	
Rotation	Continuous
Elevation	70°
Extension	12 feet (3.65 m)
Tail swing	43 inches (1.09 m)
Boom Speeds:	
Rotation	360° in 33 seconds (1.4 RPM)
Elevation	17 seconds
Extension	32 seconds
Sheave Height:	
Without Jib	26.3 feet (8.0 m)
With Jib	33.5 feet (10.2 m)
Horizontal Reach:	
Without Jib	19.2 feet (5.8 m), C/L Rotation
With Jib	27.2 feet (8.3 m), C/L Rotation

Engine:**Standard Gasoline:****Kubota 1.6L, EFI Dual Fuel, EPA Tier 2 Certified:**

Kubota WG1605-GL-E3 gasoline engine complete with multi-port electronic fuel injection, dual fuel, and engine management system. Water-cooled, 4-cylinder, 94 CID (1.6 L), 3.11-inch (79 mm) bore, 3.09-inch (78.4 mm) stroke, 57.0 HP (32.6 kW) at governed speed of 2600 rpm. Maximum torque, 88.7 ft-lbs (120.2 Nm) at 2400 RPM. 70-amp alternator, 13.5-gallon (51 L) gas tank, and 33 lb (15 kg) LPG tank.

Optional Engines and Accessories:**Kubota, Diesel, 1.8L, EPA Tier 4 Final Certified:**

Kubota D1803-CR-TIE4B diesel engine. Water-cooled, 3-cylinder, turbocharged and inter-cooled, 111 CID (1.8 L), 3.43-inch (87 mm) bore, 4.04-inch (102 mm) stroke. 49.6 HP (37.0 kW) at governed speed of 2700 RPM. Maximum torque 111.0 ft-lbs (150.5 N-m) at 1600 RPM. 12V, 60-amp alternator. Net weight: 432 pounds (196 kg).

Hydrostatic Transmission Pump:**Standard:**

Sauer-Danfoss piston type, 2.8 CID (45 mL) per revolution, direct driven from engine crankshaft. Maximum flow 34 GPM (129 L/min). Maximum pressure-4000 PSI (275 bar). Electro-hydraulic servo and electronic, automotive type controller.

Front Axle:**Standard:**

Planetary drive/steer axle with an overall 16.15/1 ratio. Differential is limited slip. Axle is rigidly mounted to frame.

Rear Axle:**Standard:**

Planetary drive/steer axle with an overall 16.15/1 ratio. Differential is limited slip. Axle oscillates 1.5° in either direction.

Steering:**Standard:**

Full-hydraulic steering unit controls a steering cylinder attached to each axle. Limited steering, if engine dies. Rear axle is the primary steer. An electric switch in the operator's compartment is used to select rear-wheel steering, four-wheel round steering, or crab steering. Electronic sensors and control box automatically align the steering when a new mode is selected.

Brakes:**Standard:**

Primary braking from hydrostatic transmission. Foot-actuated wet-disc brakes in each axle for additional braking in some conditions. Lever-actuated parking brake to hold crane when not being driven.

Tires:**Standard:**

28x9-15 pneumatic tires, 12 PR. Pressurized to 120 PSI (830 kPa) for crane rated loads.

Optional Tires:**Foam Filling of Tires:**

Standard tires, foam filled to prevent flats. Net Weight: 390 pounds (177 kg)

Solid Non-Marking Tires:

Solid tires, non-marking compound. Not for use on rough concrete surfaces or off road. Net Weight: 300 pounds (136 kg)

Spare Tire & Wheel:

28x9-15 pneumatic tires, 12-PR. Net Weight: 140 pounds (63 kg)

Chassis:**Standard:****Cargo Deck:**

29-square-foot (2.7 m²) area. A maximum of 6000 pounds (2720 kg) may be carried on the deck when centered over, or to the rear of the front axle. Nine stake pockets are provided in deck, and nine, 1-inch (25 mm) diameter pipe stakes.

Outriggers:

Four hydraulic outriggers with box beam construction. Independent controls for each. Hydraulic cylinders are equipped with direct connected holding valves. Pad dimensions are 6 inches (15 cm) by 8 inches (20 cm).

Lifting Rings:

Includes four lift rings. One at each corner of the chassis for attaching and lifting sling cables.

Front Pulling Eye:

Heavy eye in front bumper provides for attachment of hook block, so main winch line can be used for pulling loads at or near floor level.

Headlight and Taillight Grilles:

Consists of welded steel protective grilles for headlights and taillights. Easily removable or swung out of way for replacing bulbs.

Optional Chassis Accessories:**Auxiliary Winch:**

Optional worm gear winch mounted behind front bumper, with a single lever control at the operator's console. Hydraulic powered to provide bare-drum line pull of 3000 pounds (1360 kg), at 20 feet-per-minute (6 m/min). Winch drum is 3.5 inches (89 mm) in diameter by 6.2 inches (159 mm) long. The winch includes 80 feet (24.3 m) of 5/16-inch (7.94mm) wire rope, hook, and four-way roller guide. Net Weight: 120 pounds (55 kg)

Pintle Hook:

T-60-A Holland pintle hook mounted on rear frame member. Rated for 2000 pounds (910 kg) tongue weight. Net Weight: 7 pounds (3 kg)

Lifting Sling:

Sling to attach to lifting rings. Net Weight: 20 pounds(9 kg)

Rear View Mirrors:

One right-hand and one left-hand mirror, 6-inch (152 mm) diameter, mounted on deck stakes. Pivot out of way when contacted by obstacle at side of deck. Net Weight: 12 pounds (6 kg)

Operator's Compartment:**Standard:**

Operator control station provides one-position access to all chassis and crane functions. Includes adjustable operator's seat and retracting seat belt.

Drum Rotation Indicator:

Provides tactile feedback to operator when hoist drum is rotating. Feedback device attached to hoist control handle. Feedback is proportional to hoist speed.

Operator's Compartment Accessories:**All Weather Cab:**

Consists of rigid mounted canopy section and removable hinged door with safety glass. Rugged canopy structure with laminated glass front and top. Door is equipped with a keyed lock to protect operator's station. Cab door adds 2 inches (5 cm) of crane width on operator's side. Includes heater with 2-speed fan and 12V electric windshield wiper. Includes sliding window in the door, and one fold out window in rear to provide flow-through ventilation. Defroster fan and dome light included. Net Weight: 180 pounds (82 kg)

Cab Heater:

Heater with two-speed fan for units without All Weather Cab. Net Weight: 15 pounds (7 kg)

Operator Guard:

Tubular steel weldment with heavy expanded steel mesh top bolts over operator's compartment. Net Weight: 55 pounds (25 kg)

Operator Guard Cover:

Vinyl cover with windows to go over operator guard for inclement weather operations. Net Weight: 12 pounds (6 kg)

Floormat:

Ribbed vinyl mat with foam backing for operator comfort.

Electrical System:**Standard:****Electrical Group:**

12V DC.

Battery:

Group 24 with 550 CCA rating.

Lighting Group:

Consists of 2 headlights and taillights, and a 12V horn activated by button on instrument panel.

Display:

Located at operator's station and includes fuel gauge, voltmeter, oil pressure, water temperature and hydraulic oil temperature gauges. Hour meter records hours only during actual engine operation.

Outrigger Alarm System:

112-decibel alarm with alternating two-tone sound is actuated by a switch when the OUTRIGGER DOWN controls are operated.

Back-up Alarm:

Provides pulsating 97-decibel sound from solid-state alarm when ignition is ON and transmission is in REVERSE.

Optional Electrical Accessories:**Strobe Lights:**

Two yellow strobe lights mounted on turret for high visibility. Flash 60-120 times per minute. Draw 0.5 amps each. Includes operator-controlled switch.

Boom Work Lights:

Two work lights, one on the side of the boom to light the boom tip, and one on the side of the turret to light the ground under the boom tip. Includes switch at operator's station. Net Weight: 10 pounds (5 kg)

Hydraulic System:**Standard:**

Tandem pump mounted to rear end of hydrostatic piston pump, which is driven by the engine crankshaft. Delivers 6 GPM (23 L/min) at 2600 PSI (179 bar) for boom circuits and 17 GPM (64 L/min) at 2250 PSI (155 bar) for hoist circuit. System protected by relief valves and two, 10-micron filters. Hydraulic reservoir with a 14-gallon (53 L) capacity.

Boom Assembly:**Standard:**

Three-section, high-strength steel construction, equipped with bearing pads for efficient support and extension. Double-acting hydraulic cylinders extend boom sections. The primary extension cylinder and the double-acting boom elevation cylinder are equipped with direct connected holding valves. Boom angle indicator provided on the side of boom.

Main Hoist:**Standard:**

Turret mounted, planetary gear hoist is hydraulically powered to provide bare-drum line pull of 5000 pounds (2270 kg) and a line speed of 86 ft/min (26 m/min).

Main Hoist Rope:

Main hoist rope is 3/8" (10 mm) in diameter, Warrington-Seale construction, 6x36 classification, EEIP grade, IWRC core, RRL lay, minimum breaking strength 16,600 lbs (74 kN), 85' (26 m) long. Weight per foot is 0.3 lbs (0.5 kg per m). **Note that rope weight is not included in load calculations.**

Boom Swing:**Standard:**

Heavy-duty ball bearing rotation gear with external teeth support the boom. Rotation is powered by hydraulic motor and worm gear drive. 360° continuous rotation.

Boom Attachments:**Standard:****Anti-Two-Block Device:**

Has electric solenoid dump valve, which prevents damage to hoist rope and machine components from accidentally pulling load hook against boom tip. This valve will dump HOIST RAISE, TELESCOPE EXTEND, BOOM LOWER, SWING LEFT, and SWING RIGHT circuits. No other circuits are affected. These circuits are returned to normal operations by operating the HOIST LOWER or the TELESCOPE RETRACT control. This system uses a trip arm to activate switch.

Downhaul and Sheave Block:

Includes downhaul weight and hook for single-part-line. Downhaul and hook assembly weight is 40 pounds (18 kg). Downhaul is designed to clamp dead end of rope. Also includes sheave block for 2-parting line for lifts over 4000 pounds (1800 kg). Seven-inch (18 cm) OD sheave is grooved for 3/8" (10 mm) wire rope. Sheave block weight is 60 pounds (27 kg). Both attachments are specially designed to actuate the anti-two-block system.

Rated Capacity Limiter:

Operator's aid that warns operator of impending overload with audible and visual signals. Has read-outs for load, boom angle, boom length, and load radius. In the event of an overload, dumps the following boom functions: HOIST RAISE, TELESCOPE EXTEND, BOOM LOWER, SWING LEFT, and SWING RIGHT. These circuits are returned to normal by lowering the load to a safe resting place with hoist, or by retracting or raising boom to a shorter load radius. Key-operated, momentary override switch located under the dashboard.

Optional Boom Attachments:

Boom Extension, 8-Foot (2.4 m):

Provides 8 feet (2.4 m) of additional length for lifting loads with load line. Boom extension may be stowed along side base boom section when not in use. Tip sheave, attaching brackets, and pins included. Deduct 100 pounds (45 kg) from Capacity Chart when boom extension is in stowed position. Includes switch and trip arm for Anti-Two-Block system. Net Weight: 130 pounds (59 kg)

Boom Extension, 8-Foot (2.4 m), Offset:

Same as standard boom except has three settings: 0° (in-line), 15° offset, and 30° offset. Net Weight: 150 pounds (68 kg)

Searcher Hook:

2000-pound (900 kg) capacity. Swivel hook with spring latch hangs from support structure, projecting outward from boom tip. Net Weight: 30 pounds (14 kg)

***Specifications subject to change without notice.**

OPERATION SECTION

SAFETY RULES

GENERAL:

1. Since the manufacturer has no direct control over machine application and operation, conformance with good safety practice is the responsibility of the user and his operating personnel.

2.

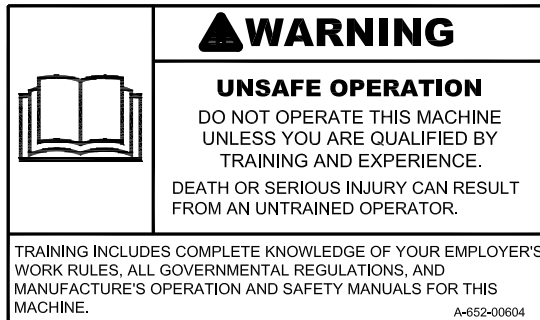

3.



4. The operator shall be responsible for those operations under his direct control. Whenever there is any doubt as to safety, the operator shall have the authority to stop and refuse to handle loads until safety has been assured.
5. The operator shall not engage in any practice which will divert his attention while actually operating the crane.
6. Do not run the engine in an enclosed area, or indoors without adequate ventilation.
8. This list of rules is only a supplement to all federal, state, and local safety rules that may apply.

CRANE CONDITION:

1. Before beginning operation each day, thoroughly inspect the entire crane to be sure it is in safe operating condition.
2. Inspect load hoist rope and wedge socket daily. We recommend rope inspection, replacement and maintenance in accordance with ASME B30.5, Sec. 5-2.4.

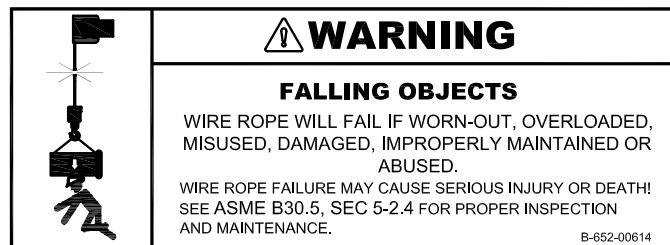

3. Keep operator's compartment and decks free of mud and grease.
4. If crane is equipped with a cab, keep all window glass clean. Keep gauges clean.
5. Tools, lubricants, or rags on the crane should be kept in a secured toolbox.
6. Do not use ether for starting. Ether is highly flammable and can be ignited by the intake manifold heater grid, causing engine damage or operator injury.

7.

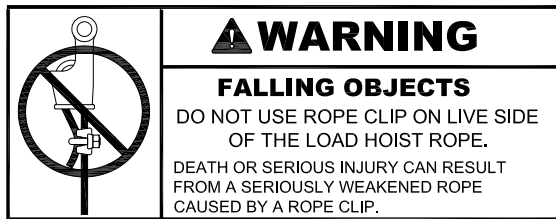

8.

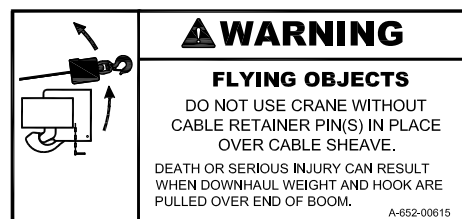

9. The Rated Capacity Limiter must be checked before each shift and after each setup for the proper operating configuration on the display. It must be inspected before each shift and tested with a known load at least once a month as described in the RCL operation manual.

LIFTING:

1. Always refer to Crane Capacity Chart in operator's compartment before handling load. Do not exceed load ratings. Under some conditions, the standard capacity ratings cannot be recommended and must be adjusted downward to compensate for special hazards. These include: weak supporting ground, wind, hazardous surroundings, operator inexperience, etc. The weight of the load should always be known.

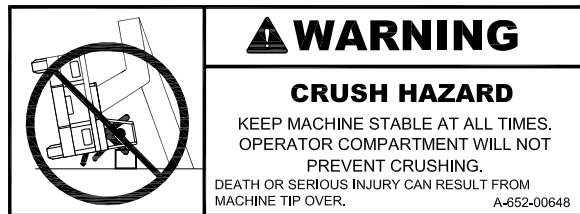

2. Be careful to prevent load swinging. A swinging load can cause instability or loss of control of the load. Be aware that the Anti-Two-Block System and the Rated Capacity Limiter can cause sudden stopping of boom movement, which can cause the load to swing. Swing the boom slowly whenever these systems might stop the boom.

3. Do not allow anyone to put any part of his body under a load. The load may lower or fall if there are damaged parts in the crane. Also, the load may drop a short distance due to thermal contraction of the hydraulic oil in the cylinders.

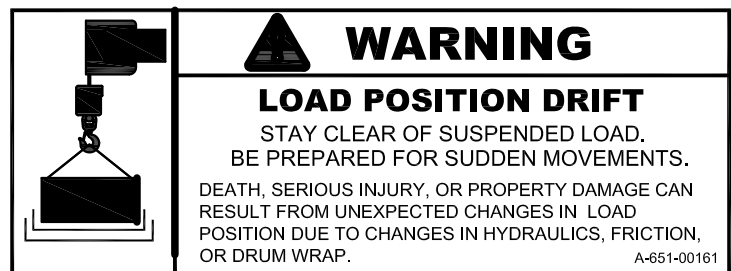

4. Do not use crane to drag loads sideways.

- 5.

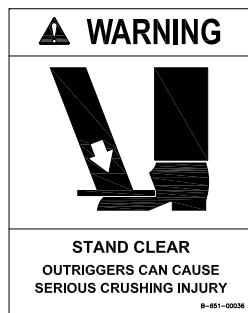

- 6.

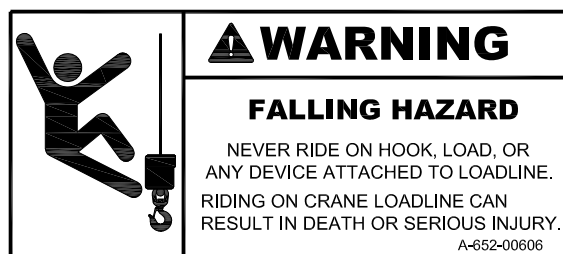

7. Level the crane before lifting. A small incline will significantly reduce the capacity. Use appropriate cribbing under the outriggers for leveling. All outriggers must be fully extended and tires must clear the ground to use the ON OUTRIGGERS ratings.

8. Always use outriggers, if possible. If you must lift on rubber, keep the load as close to the ground as possible to prevent tip-over. Move the load very slowly and use tag lines to prevent load swinging.

9. Crane may tip at less than rated loads if the surface is uncompacted or wet dirt, soft soil with frozen crust, thin or cracked pavement, or surface near a hole or ledge. Always use adequate outrigger floats and/or cribbing. See page 2-14.

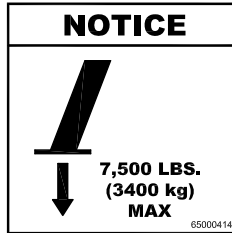

10. The operator shall not leave the controls while the load is suspended.
11. Always use adequate parts of load hoist line for lifting heavy loads.
12. Always be sure the rope is properly seated and wound evenly on hoist drum.
13. Keep hands away from load hoist rope when hoist is being operated.
14. Be sure at least three wraps of rope are left on the hoist drum to ensure against rope pulling out of its anchor.
15. Never wrap the hoist rope around a load. Always use approved rigging.
16. Avoid pinch points such as between a rotating turret and the cab, in access holes of a telescoping boom, or between the two-block mechanism.

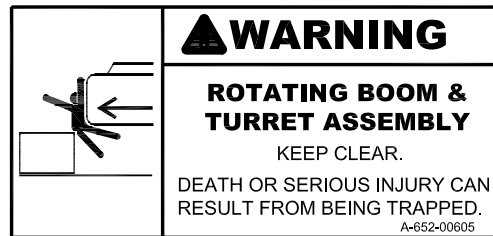
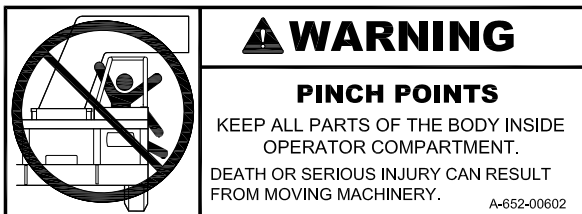

CAUTION

Keep hands out of Anti-Two-Block mechanism. Serious injury can result from moving parts.

- 17. Avoid two-blocking.
 - A. Stop raising hoist line before downhaul or hook block strikes boom tip plates.
 - B. Pay out hoist line while extending boom.
 - C. Maintain clearance between downhaul weight or hook block and boom tip while booming down.

DANGER

Two-blocking will abruptly stop boom lowering and boom swing as well as hoist and extend. If the boom is moving fast, this will cause the load to bounce or swing, which could cause loss of control of load or tipping.

- 18. The amount of counterweight supplied with this crane should never be changed. Unauthorized addition of counterweight in the field to increase lifting ability constitutes a safety hazard.
- 19. Always keep crane boom at least 10 feet (3.0 m) away from electric power lines. (See chart on side of turntable for boom clearance).

REQUIRED CLEARANCE FOR NORMAL VOLTAGE IN OPERATION NEAR HIGH VOLTAGE POWER LINES AND OPERATION IN TRANSIT WITH NO LOAD AND BOOM OR MAST LOWERED

Normal Voltage, kV (Phase to Phase)	Minimum Required Clearance	
	ft	(m)
Operation Near High Voltage Power Lines		
to 50	10	(3.05)
Over 50 to 200	15	(4.60)
Over 200 to 350	20	(6.10)
Over 350 to 500	25	(7.62)
Over 500 to 750	35	(10.67)
Over 750 to 1000	45	(13.72)
Operation in Transit With No Load and Boom or Mast Lowered		
to 0.75	4	(1.22)
Over 0.75 to 50	6	(1.83)
Over 50 to 345	10	(3.05)
Over 345 to 750	16	(4.87)
Over 750 to 1000	20	(6.10)

REF. ASME/ANSI B30.5 - 1989 B-651-00097

- 20. If boom should accidentally contact a power line, keep ground personnel away from crane. Stay in the crane until the power source is de-energized. Move the crane away from electrical hazard if this does not cause new hazards. If it is absolutely necessary to leave the crane, **jump** clear of the crane with both feet together. Hop away from the crane with feet together, as well. The ground surface may be energized.
- 21. Do not operate outside during thunderstorms. Avoid all lightning strike opportunities.

22. Crane has four lifting rings, one at each corner of load deck, for lifting the crane. Use proper slings and rigging methods to keep the load balanced during the lift. Do not lift by the boom. Proper lifting and securing practices are the responsibility of the rigger in charge.

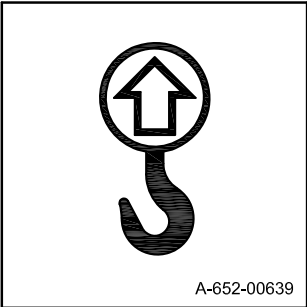

23. When transporting the crane, be sure it is properly secured to the vehicle. Utilize the tie-down anchors as indicated on the crane to stabilize the load and prevent shifting during transport. Use caution to not over-tighten the chains and binders when securing the crane to the transport vehicle. Proper securement and prudent shipping practices are the responsibility of the carrier.

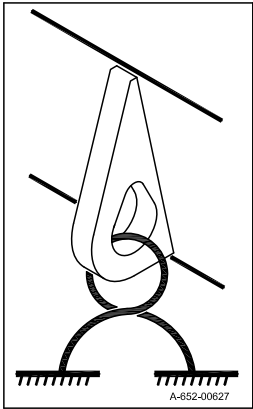
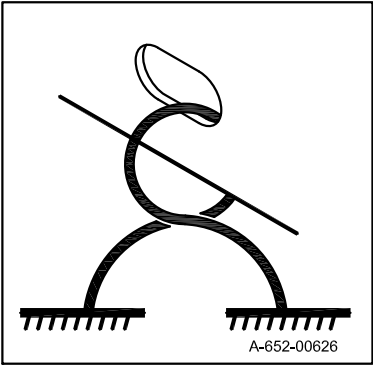

TRAVEL:

1. For Pick and Carry operation: Traveling with suspended loads involves so many variables, such as ground conditions, boom length, and vehicle acceleration, that it is impossible to devise a single standard rating procedure with any assurance of safety. For such operations, the user must evaluate prevailing conditions and determine safe practices using precautions, such as the following:
 - A. The boom shall be centered over front axle.
 - B. Use shortest boom practical.
 - C. Carry load as close to ground as practical.
 - D. Reduce travel speed to suit conditions (2 MPH (3 km/h) maximum).
 - E. Maintain specified tire pressures.
 - F. Avoid sudden starts and stops.
 - G. Provide tag or restraint lines to snub swinging of the load.
 - H. Hand-held tag lines should be nonconductive.
 - I. Do not carry heavy boom loads and deck loads at the same time.
 - J. Do not pick and carry with boom extension installed.
 - K. Do not exceed the OVER FRONT, ON RUBBER capacity.
2. When raising the boom or moving the unit with boom elevated, be sure there is adequate overhead clearance for boom.
3. For carrying loads on decks:
 - A. Boom must be retracted, centered, and lowered as close as possible.
 - B. 2 MPH (3km/h) maximum road speed. Reduce speed below 2 MPH (3km/h) to properly match condition of road surface and deck load stability.
 - C. Remove load hook from load before traveling.
4. Cranes with rear steering require close watch because of *tail swing* when the chassis is turned in tight quarters.
- 5.



6. Every effort has been made to make the BMC Industrial Crane a stable vehicle. However, with the rigid front axle and the unsprung oscillating rear axle suspension, the operator must take care to control the vehicle speed to be compatible with conditions of rough roads or uneven terrain.
7. When this crane is to be parked on a grade, set parking brake and block wheels or extend outriggers fully.

8. Shut off engine before refueling, and remove fuel cap slowly. Vapor pressure in tank can cause a burst of fuel and vapor when the cap is removed. Always refuel with proper fuel and into proper tank.
- 9 Know your visibility limitations. Loads being carried on the deck or hanging on the hook can add further limitations to visibility during travel. Always use a signal person when in doubt.

OPERATION

INSTRUMENTS AND CONTROLS

The Broderson IC-40 instrument panel is equipped with a display screen showing electrical system amperage, fuel level, oil pressure, water temperature, hydraulic oil temperature, and engine hours. Also included, is a bubble level, to level the machine.

The IC-40 is equipped with a lighting package, including an on-off switch, two headlights, and two taillights. A horn button is located on the instrument panel.

The ignition switch is key-operated and has OFF, RUN and START positions. The ignition switch should always be turned off and the key removed when the vehicle is left unattended.

The hydrostatic transmission control switch is also located on the right instrument panel. It has FORWARD, NEUTRAL, and REVERSE positions. The speed of the transmission is controlled by the engine speed, which is controlled with the accelerator pedal. The standard four-wheel drive is a full time system and cannot be disengaged.

A neutral safety switch in starter circuit prevents starting engine with the transmission engaged. The control lever must be in neutral to start engine.

A pedal-activated brake is provided to hold the machine on slopes. Normal braking is provided by the hydrostatic transmission when the accelerator pedal is released. The brake pedal actuates disc brakes inside the hubs. The parking brake is applied by a lever on the dash.

Three-mode steering is standard. Rear steer, four-wheel round steer, and crab steer can be selected with a switch on the dashboard. The steering wheel is directly mounted to the steering control unit of the all hydraulic power steering system. The system will provide limited steering even if the engine stops running.

The Rated Capacity Limiter display and input panel are mounted on the dashboard. Instructions are in the RCL Operation Manual and additional information is in the *Operating the Crane* section, the *Crane Capacity* section, and the *Maintenance Section* of this manual.

CONTROL FUNCTIONS

The controls for operating the outriggers, boom swing, boom elevation, boom telescope, and hoist are located on the control panel. The handles are directly connected to the four-way hydraulic control valves. The placards adjacent to these handles identify the function controlled and the movement resulting from each handle actuation.

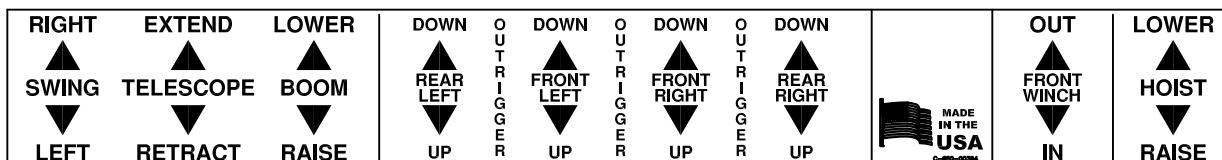

Swing: Pulling back on the lever will rotate the boom to the operator's left. Pushing forward will rotate it to the operator's right.

Boom: Pulling back will raise the boom. Pushing forward will lower it.

Telescope: Pulling back on the lever will retract the boom. Pushing forward will extend the boom.

Hoist: Pulling back on the lever will raise the hook. Pushing forward will lower the hook.

Outriggers: The four outriggers may be operated simultaneously or individually. Special attention must be given to avoid hitting personnel or obstacles.

The boom and hoist controls may be used for simultaneous operation to achieve combinations of movements. Some controls must be used together. For instance, the boom telescope and the hoist controls must be used together to maintain clearance between boom and load line hook.

Avoid holding a control lever in the open position after the function has reached the end of its travel. This will impose unnecessary stresses on the components and heat the hydraulic system.

THREE-MODE STEERING FUNCTIONS

The IC-40-2D is equipped with three-mode steering: four-wheel round steering can be used for making tight turns, two-wheel rear steering should be used for traveling long distances, and crab steering can be used for maneuvering in tight places. A switch on the dashboard sets the mode. Electronic sensors and controls automatically align the wheels when a new mode is selected, as the wheels are steered past the centered position.

SEQUENCE OF OPERATION

DRIVING THE VEHICLE

The following procedure is recommended for driving the vehicle to the job site:

1. Perform the daily inspection and test. (See Page 3-4)
2. Apply park brake.
3. Leave hydrostatic transmission switch in neutral.
4. Start engine and allow a warming period. (If equipped with Safety Shutdown System, depress reset button while starting, and for a few seconds after.)
5. Set up the Rated Capacity Limiter configuration while warming the engine.
6. Stow boom over front.
7. Pull hoist line snug.
8. Retract outriggers.
9. Step on the brake pedal.
10. Turn parking brake off.
11. Place transmission switch in FORWARD or REVERSE.
12. Release brake and press on accelerator pedal gradually until movement starts. There is a built-in delay after pedal movement, before the vehicle moves.
13. Slow down when making turns.
14. Release accelerator pedal gradually to slow down and stop.
15. Step on brake pedal for abrupt stop.
16. Set park brake and outriggers or wheel chocks to park.

WARNING

Engine exhaust contains carbon monoxide, a poisonous gas that is invisible and odorless. Breathing engine exhaust fumes can cause death or serious illness. Do not run the engine in enclosed areas without adequate ventilation.

To start the engine, the transmission switch must be in NEUTRAL. The switch should always be kept in neutral except for travel. Step on the brake before switching to FORWARD or REVERSE. Then release the brake and push the accelerator pedal to begin travel. Motion begins at about 1500 RPM engine speed. (Idle speed is about 700 RPM & maximum speed is about 2500 RPM for the gas engine, and 2600 RPM for diesel.)

The hydrostatic transmission will normally stop the crane on a grade -- but some oil will slip through the wheel drive motors and allow the crane to creep. ALWAYS apply parking brake when operating the crane, or leaving the crane unattended. Also, extend the outriggers if possible. Remember the hydrostatic transmission is NOT a parking brake.

On level surfaces, the brake pedal is not required for normal stopping. On slopes, the operator may have to coordinate the brake and the accelerator to make smooth starts and stops. Emergency stops can be made more quickly by stepping on the brake pedal. This combines hydrostatic braking with the action of the disc brakes. Operating both accelerator and brake pedal with the right foot is preferred. Using the left foot on the brake pedal while simultaneously using the right foot on the accelerator will allow the engine to over-speed.

WARNING

Abrupt braking from stepping on the foot brake at travel speeds may cause loss of control of a load on the hook or on the deck. The operator should anticipate stops, and slowly let up on the accelerator pedal to make *smooth* stops.

DANGER

Like other mobile cranes, the IC-40 will tip over more readily than some types of vehicles. The operator should always control the vehicle speed to be compatible with terrain or road conditions.

OPERATING THE CRANE

The following procedure is recommended for placing the crane in operation:

1. Perform daily inspection and test. (See Page 3-4)
2. Apply park brake.
3. Leave transmission control switch in neutral.
4. Start engine and allow a warming period at low RPM.
5. Set up the Rated Capacity Limiter configuration while warming up the engine.
6. Move accelerator pedal between medium and full speed.
7. Set all outriggers fully down on firm, level surface. Use timber or steel plate cribbing under outrigger shoes, as needed, on soft ground. Outriggers must remain set during all crane operations except for *Pick and Carry*.
8. Meter the controls when beginning or terminating movement to prevent sudden starting or stopping. This imposes undue shock loads on the equipment, especially when handling heavy loads. The control should be slightly actuated to begin movement and then slowly increased to desired speed. The accelerator may be depressed fully for maximum operating speed.
9. Release accelerator during idle time.

NORMAL GAUGE READINGS

Engine Coolant Temperature - Allow engine to warm up to 100° F (38° C) before operating crane. Stop engine if temperature exceeds 220° F (104° C) degrees.

Engine Oil Pressure - Stop engine if oil pressure does not exceed 10 PSI (0.7 bar) at low idle. Pressure varies with engine RPM.

Transmission Temperature - Normal operating temperature is in the range of 75° to 200° F (24° C to 93° C). If the reading on the gauge which starts at 100° F (38° C) exceeds 200° F (93° C), shut down the unit and determine the cause of excessive heating.

Level Indicator- Do not operate crane if it is not level.

Fuel - Do not allow fuel tank to become empty. The engine will be difficult to restart and may require *bleeding* of diesel injectors. Keep tank full when idle to prevent condensation in tank.

WARNING

Vapors can be formed inside a fuel tank and cause a buildup of pressure that can result in a sudden expulsion of gasoline and gasoline vapors from the filler neck when the fuel cap is removed from a hot tank. Remove cap slowly. Fuel spray may cause injury.

RATED CAPACITY LIMITER (RCL)

A Rated Capacity Limiter is installed on the crane to assist the operator in estimating loads and measuring load radii. Please read the *RCL Operation Manual* for complete instructions on operation of the system. Following, are some additional operating tips.

Always be aware that the RCL can stop boom movement at capacity load conditions and in two-blocking conditions. Use good judgment in controlling the speed of boom movements, to prevent shock loads and swinging loads.

If the RCL system stops the crane movement there are various remedies that may be used to restart operation. If the hook is two-blocked, it should be lowered using the HOIST control, if safe. The BOOM RAISE and TELESCOPE RETRACT may also be used if this is safer. In some unusual circumstances it may be necessary to swing the boom before lowering the load. If you are sure this will not cause an overload, you can turn the override key that is under the left instrument panel, and swing the boom to a safer position.

If the load is the maximum for the load line or attachment, the load should be set down in a safe place using the HOIST LOWER control, and the load or attachment changed. TELESCOPE RETRACT may also be used, and SWING may be used, if safe, as described in the preceding paragraph. **DO NOT** use the BOOM RAISE control as this may increase the overload.

If the load is at the maximum allowable load radius, the boom can be raised or retracted to a safe radius, or the load may be lowered to a safe place using the HOIST control. If the boom extension is at its angle limit, the boom must be raised or the load hoisted down.

If the boom is fully lowered until it stops, (about 0°) the RCL will show an overload condition because the boom lift pressure sensors cannot read a useful pressure in this condition. To remedy this, raise the boom slightly. On the other hand, if the boom is fully raised (about 70°), the RCL may show an overload condition because the pressure in the boom lift cylinder is sensed to be an overload. To correct this condition, the override key may be turned & held, and the boom lowered just slightly. Then check for other conditions before lowering further.

If there is a malfunction of the RCL or Anti-Two-Block system that causes loss of boom movement and cannot be remedied by the procedures above, the override key switch under the dashboard may be required to move the boom.

W A R N I N G

We recommend the emergency override switch be used with discretion. Improper or careless use of this switch can cause damage to the crane and endanger people and property. The operator who uses the switch in an emergency should use good judgment.

There is a light on the dashboard to warn that one or more outriggers is not fully extended when using the ON OUTRIGGERS setup on the RCL. Check the light daily (when the outriggers are down and when there is no load on the hook) by raising and lowering each outrigger about three inches. The light should come on when an outrigger is up.

CRANE CAPACITY

Before lifting loads, the operator must read the **Crane Capacity Chart** and adhere to the load capacities and radii of handling given. The information provided on this chart is based on stability, structural strength, and hydraulic capacity.

To operate the crane safely, the operator must know the weight of the load and handling devices, and the radius of the lifting operation. The crane must not be loaded beyond the specifications of the capacity chart, except for test purposes as provided in *ASME B30.5 Section 5-2.2*. The person responsible for the lift must be sure that the load does not exceed the crane ratings at any radius, at which the load may be during the entire lifting operation. The weights of the hooks, blocks, downhaul weights, slings, and other handling devices must be added with the load.

The **Rated Capacity Limiter** on the crane is intended to assist the operator in estimating loads & measuring load radii, and to alert the operator to impending overload conditions. The use of the Rated Capacity Limiter does not replace the requirements of the preceding paragraph. Verified weights and measured radii must take precedence over the Rated Capacity Limiter readings. Please read the *RCL Operation Manual*.

The Rated Capacity Limiter displays a load, load radius, and boom angle that are obtained from electronic calculations using readings from pressure, length, and angle sensors. These readings cannot be exact and should be treated as estimates. In general, the smaller the load and the higher the boom angle, the larger the percent of error. The electronic and mechanical components cannot be 100% fail-safe. Do not consider the system as a substitute for good judgment, training, experience, or accepted, safe operating practices. The operator is solely responsible for operation of the crane. Setting the Rated Capacity Limiter for the configuration of the crane is necessary before starting a lift. If incorrectly set, the system will not alert the operator to an impending overload, possibly resulting in the loss of life or destruction of property.

If the Rated Capacity Limiter is inoperative or malfunctioning, repair or recalibration of the unit must be done as soon as reasonably possible. Also, the person responsible for lifts must establish procedures for determining load weights & radii, and conduct the lifts according to the second paragraph above.

The Rated Capacity Limiter is designed to stop crane functions that could cause an overload or two-blocking. These are: BOOM LOWER, TELESCOPE EXTEND, HOIST, RAISE, SWING LEFT and SWING RIGHT. Great care must be exercised when handling a load near capacity or near a two-blocking condition. If the boom is being lowered or swung, the load will tend to swing if the Rated Capacity Limiter stops the boom movement. If the load is moving too fast, the sudden stopping by the system can cause dangerous load swinging, which can cause death or injury to personnel or property damage by impact with the load, or by the crane tipping.

WARNING

The Rated Capacity Limiter can suddenly stop the BOOM LOWER and SWING functions, causing the load to bounce or swing. Use great care when handling a load near capacity limits or near a two-blocking condition.

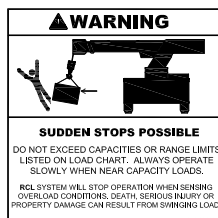

CRANE CAPACITY CHART DEFINITIONS AND RULES:

The load radius is the horizontal distance from the centerline of boom rotation (the center of the turntable when it is level), to the vertical load line, with the load suspended. Because of deflections of the boom and carrier, the load radius increases when a load is hoisted from its resting place. The load radius may be measured with a measuring tape. If the desired load radius falls between two load radii on the chart, it is recommended to use the load radius with the lower capacity, and not try to interpolate between the numbers.

Load capacity ratings on this equipment are given on the basis that operations are to be conducted on firm & level terrain, and in a safe environment. These capacity ratings are reduced in proportion to the deviation from the prescribed conditions. Any unfavorable environmental condition, such as soft, sloping or uneven terrain, high wind, or hazardous surroundings, constitutes a deviation.

The main boom capacities are given in direct relation to the radius at which the load is being handled. Boom extension capacities depend on the boom angle, as well as the load radius. The capacities shown on the capacity chart are the maximum allowable at the indicated radius. The greatest load that may be handled by the BMC **IC-40** is 9000 pounds (4080 kg), but only at a 4-foot (1.2 m) radius, and on outriggers. All variances of loads and radii of handling are shown on the crane capacity chart. A metal chart is attached near the operator's seat, and a laminated chart is included in the literature compartment for the express purpose of informing the operator when a load can or cannot be safely handled. The capacities shown in the 360° ROTATION columns of the capacity chart apply to the entire 360° rotation of the boom and are maximum allowable at the indicated radius. The capacities OVER FRONT are limited as follows:

- On Outriggers:** Boom rotation is limited to an arc of 15° either side of the crane centerline.
- On Rubber:** Boom rotation is limited to the boom centered over front. *Pick and Carry* operations are limited to the boom centered over front.

Note that the 360° ROTATION capacities at some load radii are much less than the OVER FRONT capacities. The least stable position of the boom is over the side of the crane. Use great care when swinging a load from the front or rear of the crane, toward the side of the crane. The load must be known in order to assure that the crane will not tip.

NOTICE

Under certain load conditions, torsion induced in the chassis can cause it to twist. This may result in an opposite-side outrigger or tire lifting free from the supporting surface. This is most likely to occur when the boom is positioned over one corner of the machine. The condition does not indicate a loss of stability when working within the limits of the capacity chart. Provided the crane capacity has not been exceeded, operation may continue without restriction.

CAUTION

A capacity load may be carried on the boom, or a capacity load may be carried on the deck. DO NOT carry capacity deck loads and capacity boom loads at the same time.

CAUTION

The capacities of this crane are based on all outriggers being **FULLY EXTENDED** to a firm, level surface. The crane may tip at less than capacity loads if operated in the following manner:

- A. Outriggers only partially extended and resting on curbing, shoring, etc. If the outriggers are not all the way **DOWN**, they are not all the way **OUT**.
- B. Outriggers extended to a surface that appears to be firm, but is unable to support the outrigger pad at full rated loads. Examples of this type surface are:
 - 1. Thin or cracked blacktop or concrete.
 - 2. Dirt that appears dry and firm on top, but is moist or unpacked beneath the surface.
 - 3. Dirt with a frozen but thin crust.
- C. Crane operated on a hill or sloping surface. Crane will tip at less than rated capacity when load is lifted on downhill side.

CAPACITY EXAMPLE

Refer to the IC-40-2D Capacity Chart on the following page. A load weighing 4600 pounds (2090 kg) is to be lifted onto the deck of the crane for transport to a new location. The closest we can get to the load is at a 6-foot (1.83 m) load radius over the side. We see on the chart that 4500 pounds (2040 kg) is the maximum load on a one-part line, so the sheave block is required. The charts show the weight of the standard sheave block to be 60 pounds (27 kg). The rigger says that two slings are required, weighing a total of 40 pounds (18 kg). The total load is $4600+60+40=4700$ (2135 kg).

Looking at the 360° ROTATION, ON RUBBER column we see that the load is too heavy for this condition. The OVER THE FRONT, ON RUBBER column shows that we can lift 5100 pounds (2250 kg) at a 6-foot (2.0 m) load radius. However, we cannot get that close to the load, so the load cannot be lifted this way. This leaves the ON OUTRIGGERS columns. The outriggers should always be used whenever possible anyway. We see that we can lift up to 5850 pounds (2400 kg) at a 6-foot (2.0 m) load radius, either over the front or over the side. Checking the chart again, we see that the load is within the deck load limit of 6000 pounds (2720 kg). **Note:** The travel speed with the load must be limited to 2 mph (3 km/h), or less if conditions dictate.

WARNING

The Rated Capacity Limiter can suddenly stop the **BOOM LOWER** and **SWING** functions, causing the load to bounce or swing. Use great care when handling a load near capacity limits or near a two-blocking condition.

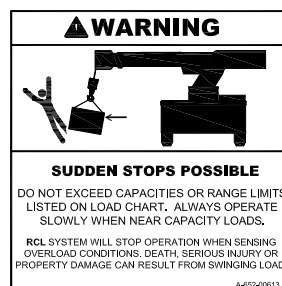

CRANE CAPACITY CHART FOR IC-40-2D

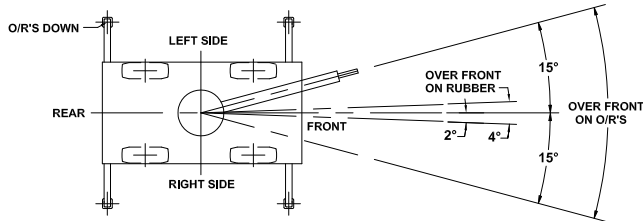
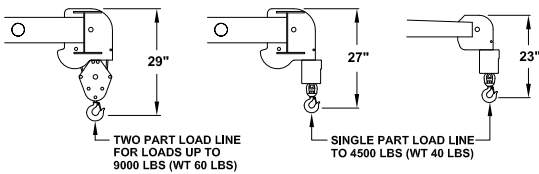
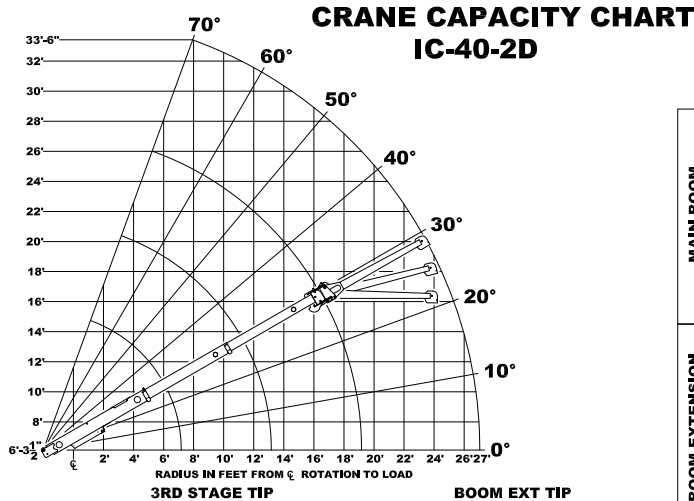

LOAD RADIUS IS THE HORIZONTAL DISTANCE FROM THE CENTER OF ROTATION OF THE UNLOADED CRANE TO THE VERTICAL LOAD LINE WITH THE LOAD APPLIED.

LOAD HOOKS, DOWNHAUL WEIGHTS, HOOK BLOCKS, AND OTHER LOAD HANDLING DEVICES EXCEPT HOIST ROPE SHALL BE CONSIDERED PART OF THE LOAD.

PICK AND CARRY WITH THE SHORTEST PRACTICAL BOOM, CENTERED OVER THE FRONT. OPERATE WITH THE BOOM AS LOW AS POSSIBLE, WITH THE LOAD CLOSE TO THE GROUND. PICK AND CARRY CAPACITIES ARE FOR SMOOTH, LEVEL PAVED SURFACE.

DECK LOAD 6000 LBS MAX, CENTERED BETWEEN WHEELS, WITH NO BOOM LOAD. DECK LOADS MUST BE CENTERED BEHIND THE FRONT AXLE. SPEED MUST BE LESS THAN 2 MPH. MAXIMUM TRAVEL 200 FT. IN 30 MINUTES.

CAPACITIES APPLY TO OPERATION ON FIRM LEVEL SURFACE

LOAD RADIUS FEET	MAIN BOOM OR EXTENSION CAPACITIES IN POUNDS							
	360° ROTATION		OVER FRONT					
	ON RUBBER	ON OUTRIGGERS	ON RUBBER	ON OUTRIGGERS				
4	7000	8500	7200	9000				
5	5000	7000	6000	7000				
6	3700	5850	5300	5850				
8	2300	4150	4150	4150				
10	1450	3400	3200	3400				
12	1050	2850	2400	2850				
14	900	2350	1900	2450				
16	750	1900	1600	2150				
18	650	1600	1300	1950				
19	600	1450	1150	1850				
20	550	1450	1150	1600				
22	450	1250	1000	1450				
24	400	1050	850	1300				
26	350	850	750	1150				
27	300	750	650	1100				
8-FOOT BOOM EXTENSION - STRAIGHT OR OFFSET								
EXTENSION MAIN BOOM ANGLE								
ANGLE	0°	10°	20°	30°	40°	50°	60°	70°
* 0°	1100	1200	1300	1450	1600	1850	2300	3500
* 15°	—	—	1100	1250	1350	1500	1700	2050
* 30°	—	—	—	1100	1200	1300	1450	1600

+ USE 0° FOR STRAIGHT BOOM EXTENSION.
* USE 0°, 15° OR 30° FOR OFFSET BOOM EXTENSION.

EXCEEDING CAPACITY RATINGS OR APPLYING SIDE LOADS TO THE BOOM OR BOOM EXTENSION IS MISUSE, IS HAZARDOUS, AND VOIDS WARRANTY.

CAUTION: BOOM EXTENSION LOADS MUST NOT EXCEED MAIN BOOM CAPACITY. DEDUCT 100 LBS. FROM CAPACITY WHEN BOOM EXTENSION STOWED ON BASE BOOM. DO NOT PICK & CARRY WITH LOADS ON BOOM EXTENSION. ENSURE ANTI-TWO-BLOCK SWITCH IS FUNCTIONAL AFTER DEPLOYING OR STOWING BOOM EXTENSION.

CAPACITIES ON OUTRIGGERS ARE 85% OF TIPPING LOADS. CAPACITIES ON RUBBER ARE 75% OF TIPPING LOADS. CAPACITIES BELOW BOLD LINE ARE LIMITED BY TIPPING. OTHER CAPACITIES ARE LIMITED BY STRUCTURAL OR HYDRAULIC CAPABILITIES.

BOOMS ON THIS UNIT ARE ALL STEEL AND HAVE NO LINE VOLTAGE RATING.

THE LOAD LINE ON THIS UNIT MUST BE 3/8 DIA. 6X36 EEIP RRL IWRC WIRE ROPE (OR EQUIVALENT) WITH A MINIMUM BREAKING STRENGTH OF 16,600 LBS. 85 FEET LONG.

OPERATION:

1. READ AND UNDERSTAND OWNERS MANUAL BEFORE OPERATING THIS CRANE.
2. CHECK LEVEL OF ENGINE OIL AND HYDRAULIC OIL DAILY.
3. CHECK UNIT FOR VISIBLE DEFECTS DAILY.
4. EXTEND OUTRIGGERS FULLY IF POSSIBLE. IF NOT, USE "ON RUBBER" CHART.
5. AVOID QUICK STARTS AND STOPS WHEN OPERATING OR DRIVING CRANE.

TIRE PRESSURE: 120 PSI FOR 28 X 9-15 12PR, 28 X 9-15 14PR.

MAXIMUM HYDRAULIC PRESSURE 2600 PSI.

MODEL NO. SERIAL NO. DATE OF MFR.

IC-40-2D		
-----------------	--	--

**BRODERSON MANUFACTURING CORP.
LENEXA, KANSAS**

65401043

CRANE CAPACITY CHART FOR IC-40-2D METRIC

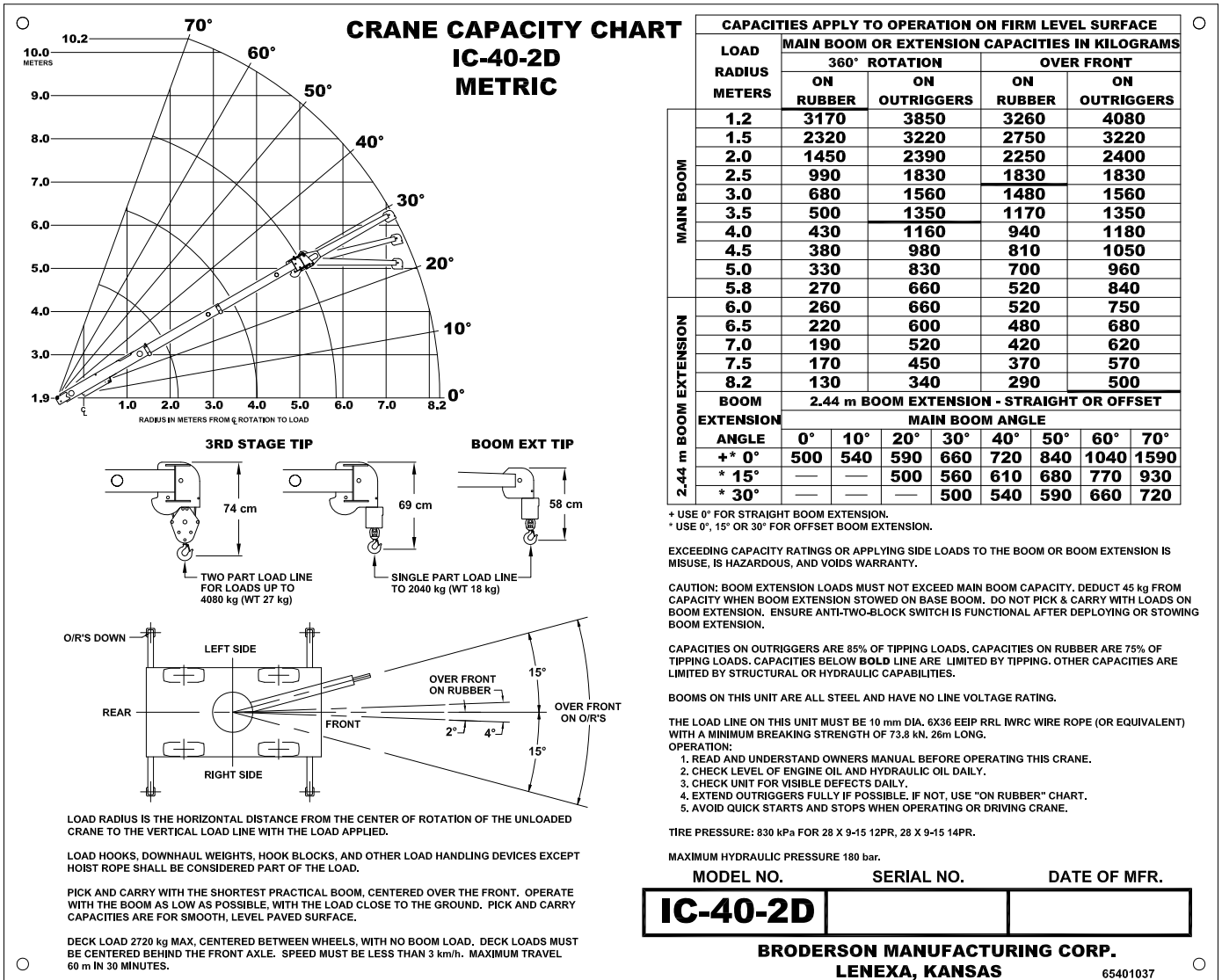

SHEAVE BLOCK AND DOWNHAUL WEIGHT

The capacity chart shows the approved hoist rope arrangements. The downhaul weight and sheave blocks supplied by Broderson are specially designed to operate the anti-two-block system. Other blocks or downhauls may bypass this system and create a dangerous condition. Notice the load limit for each hoist rope arrangement.

The keeper pins that pass through the sheave plates must be locked in place with cotters to hold the line on the sheaves. The load line must pass through the center of the downhaul, through the wedge socket, and the dead end clamped in the block, as shown in the figure below.

WIRE ROPE INSTALLATION

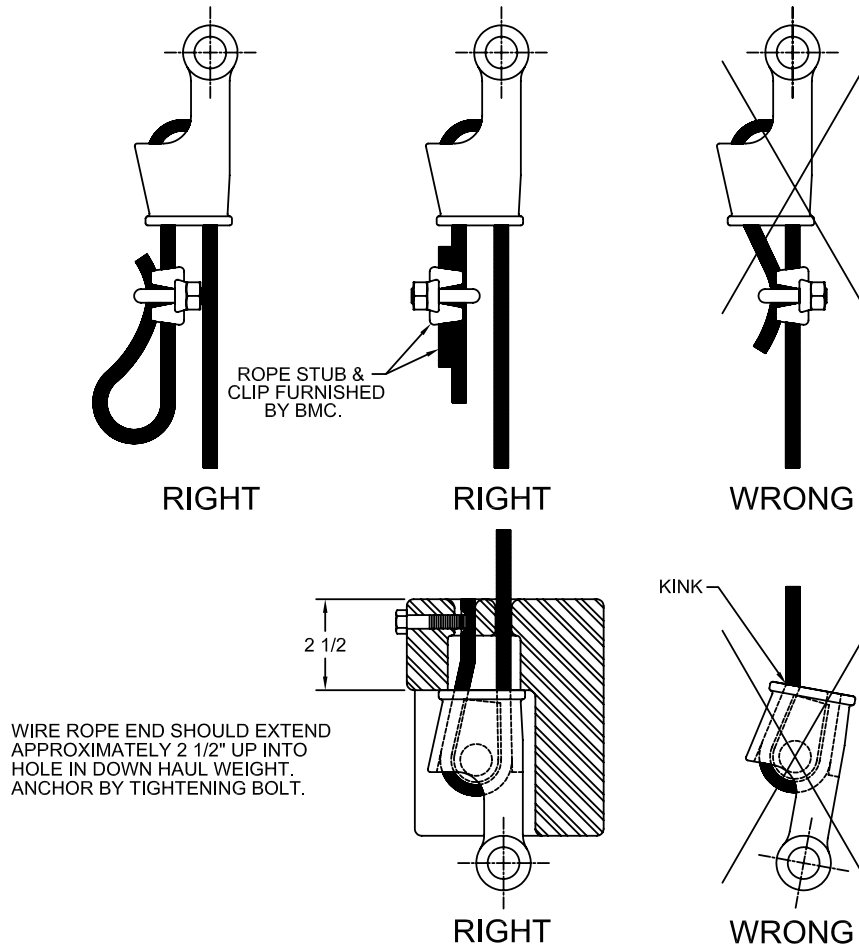

When resting the downhaul or sheave block on the ground for changing it, use the following procedure to prevent fouling the load line on the hoist. Raise the boom about 5 feet (1.5 m) and lower the hoist until the hook nearly touches the ground. Then lay the hook on the ground by lowering the boom, not the hoist.

TWO-PART LINE REEVING

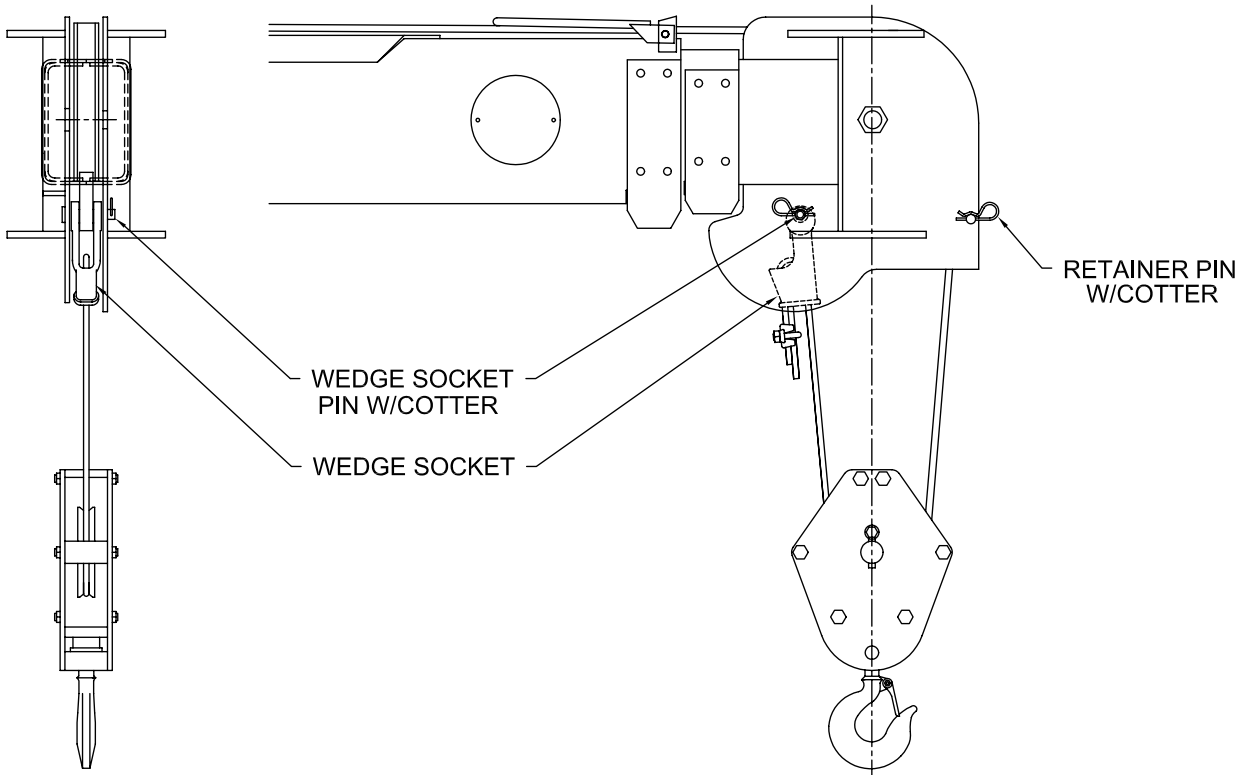

	WARNING
	FALLING OBJECTS DO NOT USE ROPE CLIP ON LIVE SIDE OF THE LOAD HOIST ROPE. DEATH OR SERIOUS INJURY CAN RESULT FROM A SERIOUSLY WEAKENED ROPE CAUSED BY A ROPE CLIP.

For loads above 4500 pounds (2040 kg), the sheave block must be used. The wedge socket should be pinned to the boom sheave plates, as shown in the figure. The dead end of the rope in the wedge socket should be clamped, as shown in the figure. The clamp must not be used on the live part of the rope. This will seriously weaken the rope by metal fatigue over a number of cycles. The sheave block should hang straight, and the top of the block should meet the boom sheave plates squarely when pulled up snugly.

SAFETY DEVICES

There are safety devices on the **IC-40** to maintain control of a load in case of power or hydraulic line failure, or human error. The operator should understand the function and operation of these devices so that a continual check on their performance can be made.

OUTRIGGER CYLINDER CHECK VALVE:

A double-acting check valve is flange-mounted on each of the outrigger cylinders. This valve holds the outrigger in the extended position should power or hydraulic line failure occur. This valve has no adjustment. If an outrigger creeps up while supporting a load, there is an internal leak in the valve or in the outrigger piston seal. In either case, maintenance is required.

BOOM ELEVATION CYLINDER HOLDING VALVE:

A single-acting holding valve is built into the cylinder barrel. This valve holds the boom in the elevated position should power or hydraulic pressure line failure occur. This valve is adjustable to hold the desired load. If the boom creeps down with loads to maximum capacity, this valve should be adjusted. If adjustment fails to correct the problem, there is an internal leak in a holding valve or a hydraulic cylinder. Refer to the maintenance instructions.

BOOM EXTENSION CYLINDER HOLDING VALVE:

A single-acting holding valve is flange-mounted to the cylinder rod end. This valve holds the cylinder in the extended position should power or hydraulic pressure line failure occur. This valve is adjustable to hold the desired load. If the boom creeps in under load, this valve should be adjusted. If adjustment fails to correct the problem, there is an internal leak in the holding valve or the hydraulic cylinder. Refer to the maintenance instructions.

HOIST BRAKE AND HOLDING VALVE:

The hoist has an automatic brake in the gearbox and a holding valve mounted directly on the hoist motor to hold the load. A clutch in the gearbox allows the winch to turn freely in the RAISE direction. The brake is pilot-released in the LOWER direction, and should allow smooth stops of a load on the hoist.

ANTI-TWO-BLOCK DEVICE:

The anti-two-block device prevents damage to hoist rope or machine components from accidentally pulling load hook against boom tip. There is a pivot arm at the boom tip that is moved upward by the load hook as it approaches the boom tip. An electric switch connected to a hydraulic solenoid valve dumps the HOIST RAISE, TELESCOPE EXTEND, BOOM LOWER, SWING LEFT, and SWING RIGHT circuits. No other circuits are affected. These circuits are returned to normal operation by operating the HOIST LOWER, TELESCOPE RETRACT, or BOOM RAISE control.

An emergency override switch is provided so the boom can be operated in case of system failure. This key-operated switch is located under the instrument panel.

WARNING

We recommend the emergency override switch be used with discretion. Improper or careless use of this switch can cause damage to the crane and endanger people and property. The operator who uses this key in an emergency should use good judgment.

WARNING

Even though the crane is equipped with an anti-two-block device, we strongly recommend that the operator always watch the downhaul and stop lifting before two-blocking occurs. Two-blocking can break the load hoist rope and let the load fall. This could cause death or serious injury.

OPTIONAL EQUIPMENT

INSTALLING BOOM EXTENSION ON TIP OF BOOM:

1. Set the outriggers.
2. Raise and extend boom 20 feet (6 m) above the ground, paying out load line until hook is just above ground.
3. Position boom over front, lower and retract boom leaving the load line on the ground.
4. If the sheave block is installed, remove it.
5. Remove load line from tip sheaves and lay over opposite side of stored boom extension.
6. Make sure the front stow pin is in place and both sets of attach pins are removed from the lugs.
7. Remove the rear stow pin and swing the boom extension away from the rear end of the boom until the attaching inner lugs mesh on the near side of the boom.
8. Insert the attach pins in these inner lugs and retain them with the hairpin cotters.
9. Remove the front stow pin and swing the boom extension around to the front until the outer lugs mesh.
10. Insert the attach pins in their outer lugs and retain them with hairpin cotters. To insert pin, it may be necessary to rock boom extension.
11. Replace the rear stow pin & front stow pin in their brackets for storage, and insert their hairpin cotters.
12. Lay the load line over the main boom and extension tip sheaves and insert the cable retainer pins and cotters.
13. Install the downhaul weight, wedge socket and swivel hook on the load line if they are not already installed.
14. Disconnect the Anti-Two-Block wiring cable from the switch on the main boom tip and connect it to the cable connector on the boom extension base.
15. Check the Anti-Two-Block System for proper operation.
16. Store the Boom Extension in reverse order.
17. Lay the load line back in the boom tip sheaves and insert both retainer pins & cotters.
18. Replace all of the pins in their lugs for storage and insert their hairpin cotters.
19. Install the sheave block on the load line, if desired.

SETTING THE OFFSET ANGLE ON THE OFFSETTABLE BOOM EXTENSION:

1. The boom extension must be installed on the main boom tip & the load line, downhaul weight & wedge socket installed on the boom extension, and secured with all of the retainer pins.
2. Draw the load line taut with the hoist by pulling the downhaul weight against the bottom of the tip sheave plates while holding the Anti-Two-Block override switch under the control panel.

WARNING

Be careful not to operate the TELESCOPE lever while overriding the Anti- Two-Block system. This may break the load line and allow the boom extension and downhaul weight to fall, causing death or serious injury to personnel.

3. Remove the offset index pin from the boom extension knuckle. To loosen the pin, it may be necessary to rock the boom extension tip up and down manually while maintaining the proper tension in the load line.
4. Lower or raise the load line with the hoist until the 0, 15, or 30 degree offset holes align in the knuckle.
5. Insert the index pin in the knuckle and retain it with the hairpin cotter.

STOWING THE OFFSETTABLE BOOM EXTENSION:

1. If the boom extension is offset to 15 or 30 degrees, return it to the zero offset position as described above.
2. Reverse the procedure described in steps 7 through 14 in the Boom Extension installation procedure on previous page.

FRONT AUXILIARY WINCH:

The front auxiliary winch is mounted behind the front bumper and is controlled from the operator compartment. The winch, with the 5/16-inch (7.9 mm) wire rope (10,500-lb (47 kn) breaking strength), and 2-ton (1810 kg) hook, has a single-part-line capacity of 3000 pounds (1360 kg). A pulling eye is provided below the winch for 2-parting the line with a sheave block, allowing 6000-lb (2720 kg) pulls. (An additional sheave block is not provided with this option.).

The front auxiliary winch is designed for the following uses:

1. As a tag line for restraining loads on the boom load line during *Pick and Carry* operation.
2. To drag loads on the ground to a position where they may be safely lifted with the boom.
3. To pull the crane out of mud or other obstacles.
4. To pull a smaller vehicle that is stuck.

WARNING

The front winch is not designed for lifting personnel or loads. Observe the following safety rules:

1. Never lift or carry personnel with the winch and wire rope.
2. Do not allow anyone to stand near or under the load being moved.
3. Be sure the cable is securely anchored in the drum and that at least 5 wraps of rope remain on the drum to ensure against the rope pulling out of its anchor.
4. Stand clear of a loaded winch cable. If it breaks, it can be very dangerous.
5. Keep hands clear of the winch and any sheaves that the cable passes over when the winch is being operated.



CAPACITY EXAMPLES FOR BOOM EXTENSION

The MAIN BOOM and BOOM EXTENSION capacity charts must both be considered when using the boom extension. The smaller capacity specified by the two charts must be used. Refer to the IC-40-2D Capacity Chart on page 2-16 and 2-17 for the following examples:

In this first example the boom is elevated to 30° over the side of the crane. The boom extension is offset to 15°, and the load radius is 14 feet (4 m). The outriggers are fully extended on concrete pavement and the crane is level. The column for 360° ROTATION, ON OUTRIGGERS shows the capacity at the 14-foot (4 m) load radius to be 2350 pounds (1160 kg). The column for 8-FOOT (2.4 METER) BOOM EXTENSION - STRAIGHT OR OFFSET, MAIN BOOM ANGLE 30° shows the capacity at the 15° boom extension angle to be 1250 pounds (560 kg). Since 1250 pounds (560 kg) is less than 2350 pounds (1160 kg), the load (including the downhaul weight and slings) must be limited to 1250 pounds (560 kg).

In the second example the boom is elevated to 45° over the side of the crane. The boom extension is offset to 0°, and the load radius is 26 feet (7.5 m). The outriggers are fully extended on concrete pavement and the crane is level. The column for 360° ROTATION, ON OUTRIGGERS shows the capacity at the 26-foot (7.5 m) load radius to be 850 pounds (450 kg). The column for 8-FOOT (2.4 METER) BOOM EXTENSION - STRAIGHT OR OFFSET, MAIN BOOM ANGLE 10° shows the capacity at the 0° boom extension angle to be 1200 pounds (540 kg). Since 850 pounds (450 kg) is less than 1200 pounds (540 kg), the load must be limited to 850 pounds (450 kg).

PINTLE HOOKS:

Available Pintle Hooks allow the crane to tow other disabled vehicles and trailers, and drag loads.

























1. Limit the vertical load to about 1000 pounds (450 kg) and the horizontal pull to about 5000 pounds (2270 kg).
2. Exceeding the capacities can damage the drive train.
3. Use slow and smooth motions to avoid shock loads or overrunning loads. Make sure other vehicle is occupied and controlling the vehicle being towed.





























Pintle Hooks also allow the crane to be towed for short distances.

1. Use appropriately sized straps or chains.
2. Bypass transmission, as described on page 3-16. Utilize an Operator to activate brakes as needed and steer the crane while being towed.
3. Do not exceed a towing speed of 5 MPH (8 km/h).

SWITCH AND INDICATOR SYMBOLS ON BMC CRANES

The following list shows the symbols used to label switches and indicators on BMC cranes. Most symbols are derived from the ISO 3767-1:1998(E) standard. Not all symbols will be included on your BMC crane.

	On/Start		Windshield washer switch
	Off/Stop		Windshield defroster switch
	Battery not charging		Heater switch
	Hour meter		Air conditioner switch
	Read operator's manual		Ventilation fan switch
	Sound level notification		Parking brake is set
	Headlights (main/high beam)		4-wheel (round) steer
	Work light		Rear-wheel steer
	Hazard lights		Crab steer
	Rotating beacon or strobe lights		2-wheel drive
	Turn signals left/right		4-wheel drive
	Windshield wiper switch		Steering wheel tilt

	Tire pressure		Engine oil pressure low
	Lift point		Engine coolant fill location
	Tie-down point		Engine coolant temperature high
	Transmission oil fill location		Engine coolant low level mark
	Transmission oil pressure		Engine air filter restriction indicator
	Transmission oil temperature		Engine start
	Brake fluid fill location		Engine idle set
	Hydraulic oil low-level mark		Check engine
	Hydraulic oil filter restriction indicator		Stop engine
	Hydraulic temperature gauge		Wait to start/ engine preheat/ grid heater/ glow plug switch
	Hydraulic oil temperature high		Gas fuel only
	Hydraulic oil pressure gauge OR hydraulic oil pressure low		Diesel fuel only
	Positive polarity		Fuel level gauge
	Negative polarity		Drain

MAINTENANCE

SAFETY RULES

1. Lower load and boom, shutdown engine, remove key, and put it in a safe place. Place warnings on the ignition switch and crane controls to prevent unauthorized starting or movement during maintenance. Disconnect battery when disabling crane. Disconnect battery, RCL, and engine electronic module (gas engine only) when welding on crane.
2. Relieve hydraulic pressure when working on hydraulic parts by cycling the controls with the engine shut down.
3. Allow fluids and parts to cool before working on them.
4. Read maintenance instructions before beginning work.
5. Do not check for hydraulic leaks with hands. If a mist of hydraulic oil is noticed around a line or component, use cardboard or other material to check for location of leaks. High pressure fluid leaking from a small hole, can be almost invisible, yet have enough force to penetrate the skin. If injured by escaping fluid, see a doctor at once. Serious reaction or infection can occur.
6. Wear safety glasses and shoes.
7. Do not wear loose-fitting or torn clothing.
8. Remove rings and other jewelry.
9. Wear heavy leather gloves when working on wire rope.
10. Keep fingers, clothing, and hair away from moving parts.



11. To prevent falls, clean areas of crane that are stepped on for access to crane parts. Wear slip resistant footwear.
12. Avoid placing body parts in pinch point areas. Use tools that extend through the pinch points when possible. Block the moving parts securely when it is necessary to work in pinch points.
13. When inflating or adding air to a tire, place a tire cage over the tire and use a clip-on inflater chuck with an extension hose that will permit standing behind the tire tread when inflating.
14. Do not work on any machine that is supported only by jacks or a hoist. Always use adequate blocks or jack stands.

15. If it is necessary to work on the boom or outriggers in an unstowed condition, block them to prevent them from dropping unexpectedly.
16. Use a hoist when lifting components that weigh 50 pounds (23 kg) or more. Follow all hoist and rigging safety rules.
17. Do not use lower grade fasteners if replacements are necessary.
18. When reinstalling wiring or plumbing after repairs, be sure that it will not be damaged by rubbing against sharp, rough, or hot surfaces and/or edges.
19. Never use a rope clip on live side of the load hoist rope. This will seriously weaken the rope. Death or serious injury can result from the use of a rope clip on the hoist rope.
20. Replace any instruction or warning placards that are lost or damaged or not readable.
21. Always replace all guards and covers after working on the crane.
22. After working on the hydraulic system, remove air from the lines and cylinders involved by cycling them full stroke with the engine running until the functions operate smoothly.
23. When welding on the crane or on anything connected to the crane by wire rope or other conducting link, disconnect the battery, the Rated Capacity Limiter display & computer, and the engine electronic control module (gas engine only). When welding on the boom or turntable assembly, remove the cable reel and any other electronic components bolted to these assemblies.
24. When using pressure spray to clean the crane, cover all electronic components with sheets of plastic to protect them from spray.
25. Do not allow antifreeze to contact skin. Rinse off spills immediately with plenty of water. Antifreeze is highly toxic if ingested.
26. Always disconnect negative cable first and refasten last to prevent accidental short through chassis components.

CAUTION

Even with low voltage electrical systems, severe arcing can occur. Electrical shock or component damage can result from contact with energized conductors. Use caution when working with any electrical device.

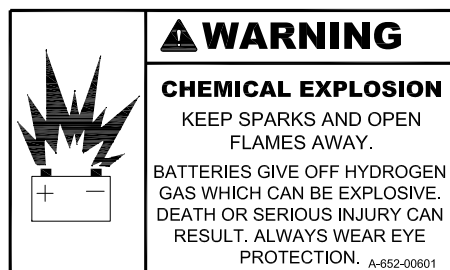

MAINTENANCE

The Broderson IC-40 Industrial Crane will perform better and longer if a program of inspection, lubrication, adjustment, and general preventive maintenance is followed. We recommend the following schedule:

NEW UNIT INSPECTION AND TEST

The following inspection and test should be made before placing the unit on the job. This will ensure that no damage or loss of operating capability occurred during shipment.

1. Check for physical damage.
2. Check for leaks at fittings and drips under chassis.
3. Check radiator coolant level.
4. Check engine oil level.
5. Check hydraulic oil reservoir level.
6. Check fuel tank level.
7. Check tire pressure.
8. Check for loose pins, bolts, and retainers.
9. Operate foot brake. Check for operation.
10. Operate park brake. Check for operation and warning light.
11. Operate throttle. Check for operation.
12. Start engine.
13. Check oil pressure.
14. Check volt meter.
15. Check power steering for operation.
16. Check transmission control switch and accelerator pedal for operation.
17. Check lights for operation.
18. Test drive unit and check for normal operation.
19. Check operation of hydraulic outriggers.
20. Check boom swing.
21. Check boom elevation.
22. Check boom extension (pay out hoist cable during power extension).
23. Perform cable break-in procedure. (see page 3-10)
24. Check Anti-Two-Block system for proper operation and cutout of boom functions.
25. Perform a load test according to the Rated Capacity Limiter Operation Manual.
26. Check the outrigger warning light for proper operation as described on page 2-12.
27. Check that Drum Rotation Indicator is functioning.

WARNING

When the Rated Capacity Limiter is inoperative or malfunctioning, it must be repaired as soon as reasonably possible. When a lift must be made without a properly functioning RCL, the designated lift supervisor must establish procedures for determining load weights and load radii and conducting the lift safely.

OPERATOR INSPECTION AND TEST

An operator, in the course of normal operation, should make certain observations, inspections, and tests to assure that the unit is ready and able to perform safely.

Daily:

1. Check radiator coolant level.
2. Check engine oil level.
3. Check general condition of tires.
4. Visually inspect for loose pins and physical damage.
5. Check fuel level.
6. Check engine oil pressure.
7. Check engine coolant temperature.
8. Check battery charging voltage.
9. Check hydrostatic transmission temperature.
10. Check hydrostatic transmission control switch and accelerator operation.
11. Check parking brake operation.
12. Check power steering operation.
13. Observe chassis for normal driving operation.
14. Observe boom operation for normal power and speed.
15. Check load line and hooks for damage.
16. Check condition of sheaves and load line retainers.
17. Check hydraulic oil level.
18. Check Anti-Two-Block system for proper operation.
19. Check back-up alarm for proper operation.
20. Check operation of Rated Capacity Limiter according to the RCL User Manual.
21. Check hydraulic hoses, particularly those that flex during crane operation.
22. Check the outrigger warning light for proper operation as described on page 2-12.
23. Check that Drum Rotation Indicator for proper operation.

Weekly:

1. Check tire pressure -- 120 PSI (830 kPa).
2. Visually inspect wheel nuts.
3. Check lights.
4. Check power steering lines for damage.
5. Check operation of horn.
6. Check operation of hoist brake for smoothness.
7. Check outrigger holding valves for operation.
8. Check boom cylinder holding valve for operation.
9. Check boom telescope cylinder holding valve for operation.
10. Check swing gears for looseness or backlash.
11. Check operation of windshield wipers (if equipped).
12. Make sure boom extension (if equipped) is properly pinned with retainers in place.
13. Clean all glass (if equipped) and check for cracks.
14. Drain water separator (diesel only)

WARNING

Vapor can form inside a fuel tank and cause a buildup of pressure. This can result in a sudden expulsion of gasoline and vapor from the filler neck when the gas cap is removed from a hot tank. Remove cap slowly. Fuel spray may cause injury.

IC-40 MAINTENANCE CHECKLIST

Refer to the component maintenance section of this manual and to the engine operator's manual for complete instructions.

50-HOUR INTERVAL:

1. 50-hour lubrication as shown on lube schedule.
2. Inspect wire rope thoroughly.
3. Inspect for physical damage and leaks.
4. Check tire pressure and condition, 120 PSI (830 kPa).
5. Clean radiator fins.
6. Change engine oil and filter after first 50 hours and at 250 hours, thereafter.
7. Change the hydraulic filters after the first 100 hours and at 500 hours, thereafter.
8. Check rotation gear and pinion fit and gear train backlash.
9. Check rotation bearing and gearbox bolt tightness.
10. Check axle mounting bolts and pins.
11. Torque wheel mounting nuts to 500 ft-lbs (680 N-m).
12. Check for loose pins or pin retainers.
13. Check steering lines for damage.
14. Inspect sheaves and hooks for damage or excessive wear.
15. Perform a load test according to the Rated Capacity Limiter User Manual.
16. Check operation of outrigger warning light as described on page 2-12.

250-HOUR INTERVAL:

1. 50-hour maintenance.
2. 50 and 250-hour lubrication.
3. Change engine oil and filter.
4. Check tension of fan and alternator belts.
5. Clean battery.
6. Inspect all bolts for tightness.
7. Visually inspect all welds for cracks.
8. Clean or change air filter (every 100 hours if used in dusty conditions).
9. Check hydraulic fittings for leaks.
10. Inspect air intake system for cracks and leaks.

500-HOUR INTERVAL:

1. 50 and 250-hour maintenance.
2. 50, 250 and 500-hour lubrication.
3. Change fuel filter element.
4. Check antifreeze for protection level and cleanliness.
5. Inspect engine fan and belt.
6. Clean crankcase vent.
7. Adjust engine valve clearance per engine manual after first 500 hours and at 1000 hours, thereafter.
8. Change hydraulic filter elements and inspect oil from elements for water or excessive contamination.
9. Check condition of all operational and warning placards.
10. Torque mounting bolts on rotation bearing and gearbox, winch, and axles.
11. Inspect boom sections for signs of overload, excessive wear, or other damage.
12. Replace air filter element.

1000-HOUR INTERVAL:

1. 50, 250, and 500-hour maintenance.
2. 50, 250, 500, and 1000-hour lubrication.
3. Adjust engine valve clearance per Engine Manual.
4. Check and adjust engine speed per Engine Manual.
5. Perform engine maintenance specified in Engine Manual.
6. Change hydraulic fluid & filters and clean breather and reservoir.
7. Replace vapor block inside slip ring. See turret sub-assembly in Parts Manual.

1500-HOUR INTERVALS:

1. 50, 250, and 500-hour maintenance.
2. 50, 250, and 500-hour lubrication.
3. Check injector tip per Engine Manual.
4. Check EGR cooler per Engine Manual (diesel only).
5. Change oil separator element per Engine Manual.

3000-HOUR INTERVALS:

1. Inspect turbocharger per Engine Manual.
2. 50, 250, 500, and 1000-hour lubrication.
3. 50, 250, 500, and 1000-hour maintenance.

6-MONTH INTERVAL: (For usage less than 250 hours in 6 months)

1. Perform 250-hour maintenance and lubrication.
2. Change hydraulic filter elements and inspect oil.

12-MONTH INTERVAL: (For usage less than 500 hours per year)

1. Perform 6-month maintenance.
2. Perform 500-hour maintenance.
3. Change hydraulic fluid & filters, and clean breather and reservoir.
4. Replace vapor block inside slip ring. See turret sub-assembly in Parts Manual.
5. Check EGR piping per Engine Manual (diesel only).
6. Check intake air line per Engine Manual.
7. Check exhaust manifold for cracks, gas leaks, looseness, or damage per engine manual.

24-MONTH INTERVAL:

1. 12-month maintenance.
2. Pressure test engine cooling system.
3. Flush cooling system.
4. Change engine thermostat.
5. Fill with new coolant and distilled water.
6. Perform engine maintenance specified in Engine Manual for 24-month interval.

S/N: _____ HOURS: _____ DATE: _____ BY: _____

COMMENTS & PARTS REQUIRED: _____

ROTATION BEARING LUBRICATION

There is one grease zerk in a hole on the right-hand side of the turntable base plate. This should be used to lubricate the bearing every 50 hours. Rotate the turntable about 45° and pump some grease into the zerk. Repeat until the turntable has rotated two revolutions. Use about 4 ounces (120 mL) of grease each time the bearing is lubricated.

Also, lubricate the gear teeth of the rotation bearing at the 50-hour interval. Remove the pinion cover. Brush open gear grease, such as Mobilkote-S, on the teeth on each side of the pinion at four places around the bearing. Rotate the boom several times and check the coverage of the grease on all of the teeth. Replace the pinion cover.

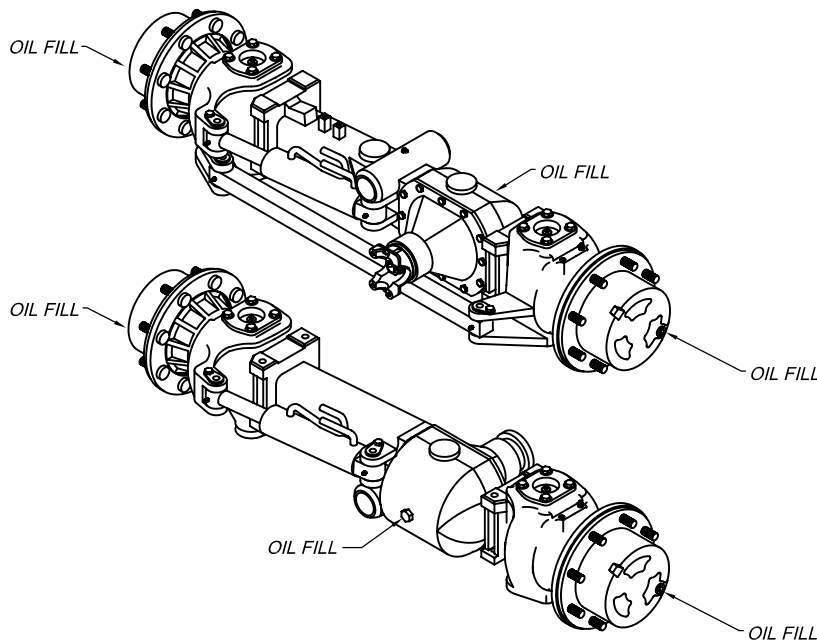

AXLES

Use Mobil 424 or equivalent.

Check oil level every 50 hours.

Drain and refill after 1,000 hours of operation or after one year of service, whichever comes first.

WIRE ROPE LUBRICATION

The wire rope should be cleaned and lubricated every 50 hours of normal operation and more frequently when used in dirty or corrosive environments. Whenever the rope is dirty or dry, it should be serviced.

The rope should be cleaned with solvent and compressed air, or solvent and rags. A wire brush may be used for difficult areas.

The recommended lubricant is AMOVIS #2-X. It should be sprayed or dripped onto the rope where it is bent, as it passes over the tip sheave. Wrap rags around the wire rope behind the sheave, and swab the excess oil that is carried along on the rope. Always wear heavy leather gloves when handling wire rope.

IC-40 LUBRICATION CHART

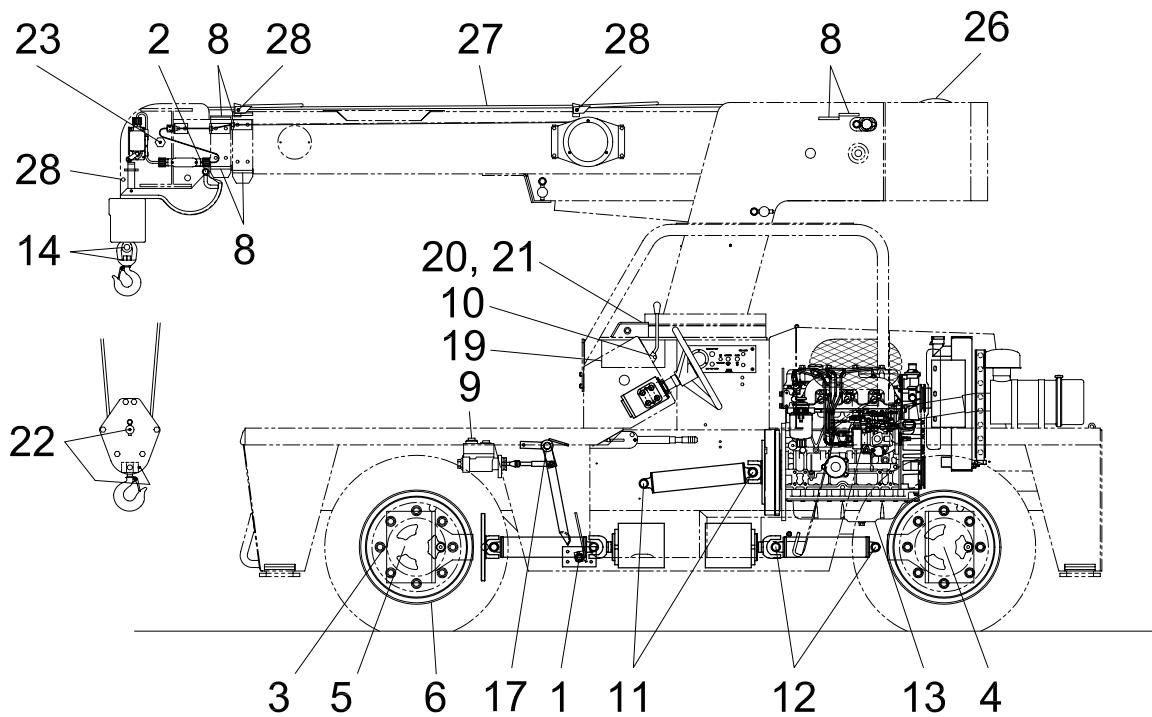
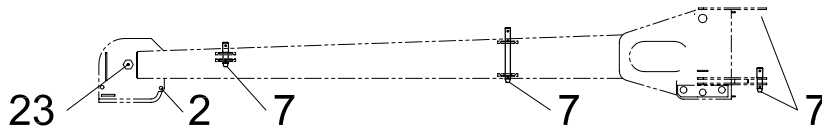
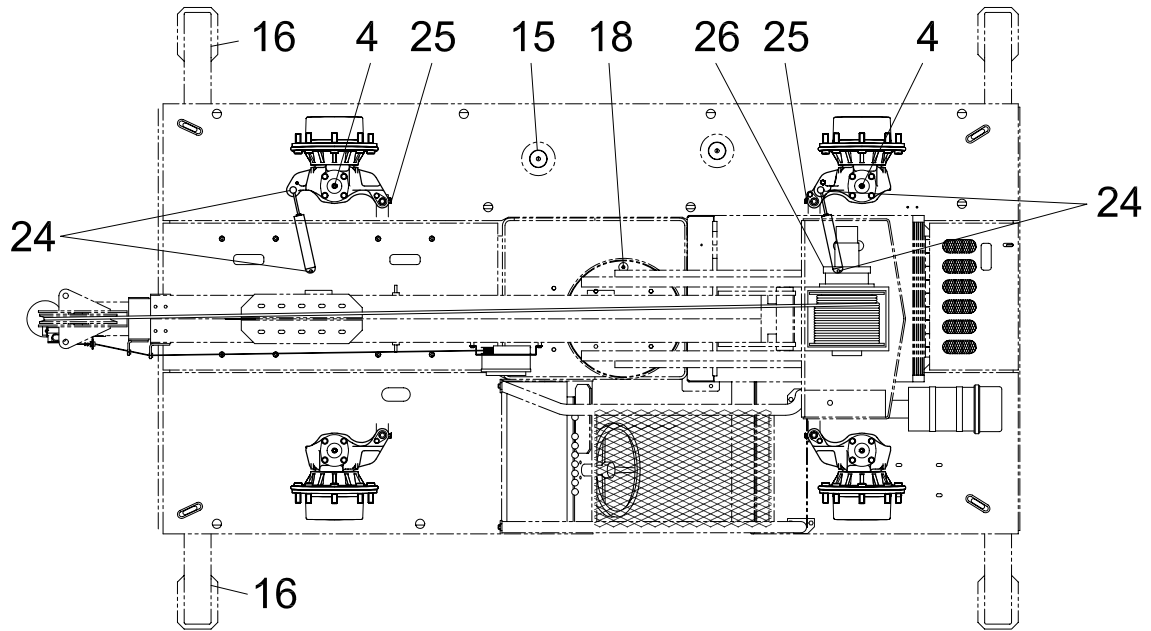

IC-40 LUBRICATION SCHEDULE

ITEM	DESCRIPTION	LUBE	LUBRICATION INTERVALS					NOTES
			50 HOUR	250 HOUR	500 HOUR	1000 HOUR	MONTHS	
1	Accelerator Linkage	SIL	X					2 Points (Not on E.F.I.)
2	Anti-Two-Block Arm	SIL	X					2 Points
3	Axle Differential	UTF	X				12	Check @50, Change @12 Mo.*
4	Axle Kingpins	MPG	X					8 Zerks
5	Axle Pivot Pin	MPG			X			2 Zerks
6	Axle Planetary Hubs	424	X				12	Check @50, Change @12 Mo.*
7	Boom Extension Pins	MPG		X				6 Pins - Wipe
8	Boom Rub Pads	SIL	X					Spray or Wipe
9	Brakes	HO	X				12	Check @50, Change @12 Mo.*
10	Control Valve Links	SIL		X				12 Points
11	Drive Shaft, Pump	MPG			X			2 Zerks
12	Drive Shaft, Motor	MPG			X			4 Zerks
13	Engine Oil	EO	X	X			6 Max.	Check Daily, Change @250 Hrs. or 6 Mo. Max.
14	Hook Swivel & Pin	MPG	X					Wipe
15	Hydraulic Oil	HO	X			X	12 Max.	Check Daily, Change @1000 Hours or 12 Mo. Max.
16	Outrigger Legs	SIL	X					Wipe Upper & Lower Sides
17	Pedal Hinges	SIL			X			2 Points
18	Rotation Bearing	MPG	X					1 Zerk*
19	Rotation Gearbox	MPL		X			12	Check @250, Change @12 Mo.
20	Rotation Gear Teeth	OGG	X					Brush On*
21	Rotation Pinion Bearing	MPG	X					1 Zerk
22	Sheave Block	MPG	X					2 Zerks
23	Sheave Pins	MPG	X					1 Zerk Std, 1 On Boom Ext.
24	Steering Cylinder Ends	MPG	X					4 Zerks
25	Steering Tie rod End	MPG	X					4 Zerks
26	Winch(es)	MPL		X			12	Check @250, Change @12 Mo.
27	Wire Rope	2-X	X					Spray, Brush or Soak*
28	Wire Rope Retainers	SIL	X					

* See Procedures in the Manual

LUBE SYMBOLS

HO - Approved Hydraulic Fluids
 EO - Engine Oil - See Specs in Engine Manual
 MPG - Multi-Purpose Gun Grease
 MPL - Multi-Purpose Gear Lube - SAE 80W-90
 OGG - Open Gear Grease, Such as Mobilkote S
 SIL - Silicone Lube - Aerosol with Concentrating Tube
 2-X - AMOVIS #2-x
 UTF - D-A Lube Hydratrans 135
 DTE - D-A Lube Hydrasafe HiVi ISO 15

FLUID VOLUMES

Axle Differential - 3 Gal. each
 Axle Hubs - 1.5 Pts. each
 Brake Reservoir - 1 Pt.
 Engine Coolant - 3 Gal.
 Eng. Oil (Nissan) - 1 Gal.
 Fuel Tank - 13.5 Gal.
 Hoist - 2 Pts.
 Hyd Tank - 14 Gal.
 Winch, Aux. Frnt - 8 Oz. each

HOIST CABLE INSTALLATION AND INSPECTION

The following steps will assure that the wire rope winds smoothly and evenly on the hoist, and will yield greater safety and longer cable life.

Refer to *Section 1* of this manual for complete replacement rope specifications.

1. If possible, the cable should be rolled off a storage spool and straightened out on the ground in line with the boom. If the ground is not clean or the space is too limited, the cable can be wound directly from the storage spool onto the hoist, but the spool must rotate in the same direction as the hoist.
2. Check the seizings on the ends of the cable and replace them if they are missing or damaged.
3. Install the cable over the boom tip sheave and route it through the cable retainer loops to the hoist drum.
4. Position the hoist drum with the cable anchor on top.
5. Insert the cable through the anchor slot and wrap it around the anchor wedge. The end of the cable should extend past the wedge by about one inch (24 mm).
6. Slide the cable and wedge into the drum socket and pull firmly on the free end of the cable to set the wedge. Seat the wedge securely with a brass or rawhide mallet.

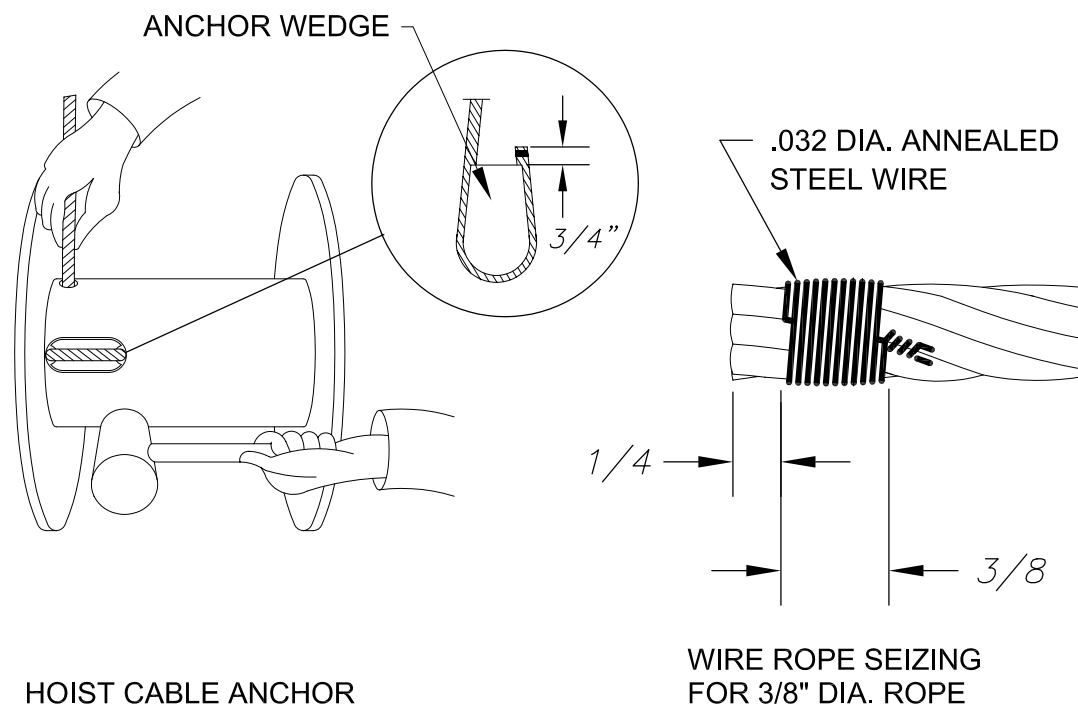

7. Slowly rotate the hoist while applying tension on the cable in front of the boom. Wear heavy leather gloves and wrap rags around the cable to wipe off any dirt from the cable. Keep hands away from the sheaves and hoist drum while the cable is moving.
8. After two turns of the hoist drum, stop the hoist and push the cable tightly against the flange of the drum with a wooden or rubber mallet.
9. Slowly rotate the drum until the first layer of cable is on the drum. If any gaps between the rope appear, stop the hoist and tap the cable toward the flange. There must be no gaps.
10. After the first layer is on the drum, the hoist may be turned a little faster until the remainder of the cable is installed.
11. Leave about 15 feet (5 m) of cable on the ground to install the sheave block. See the Operation Section for instructions on reeving and wedge socket attachment.
12. Install the cable retainer pins and cotters in the tip sheave plates.
13. For the cable break-in, lower the outriggers and attach a load of about 1000 pounds (500 kg). Extend the boom fully. Position the load at a 6-foot (2 m) load radius, over the right-hand side of the crane. Hoist and lower the load 3 times, and check winding of the rope on the hoist.
14. Attach about 3000 pounds (1400 kg) and repeat. Be sure that the cable winds evenly on the hoist.
15. If the cable appears to twist too much, remove the sheave block and rewind the cable on the drum as in steps 7-11.
16. Never lift more than the rated load on the Capacity Chart for the parts of line and type of wire rope being used.
17. Lubricate the cable as recommended in the *Wire Rope Lubrication* section. Inspect, maintain, and replace the cable in accordance with ASME B30.5, Section 5-2.4.

JIC SCHEMATIC

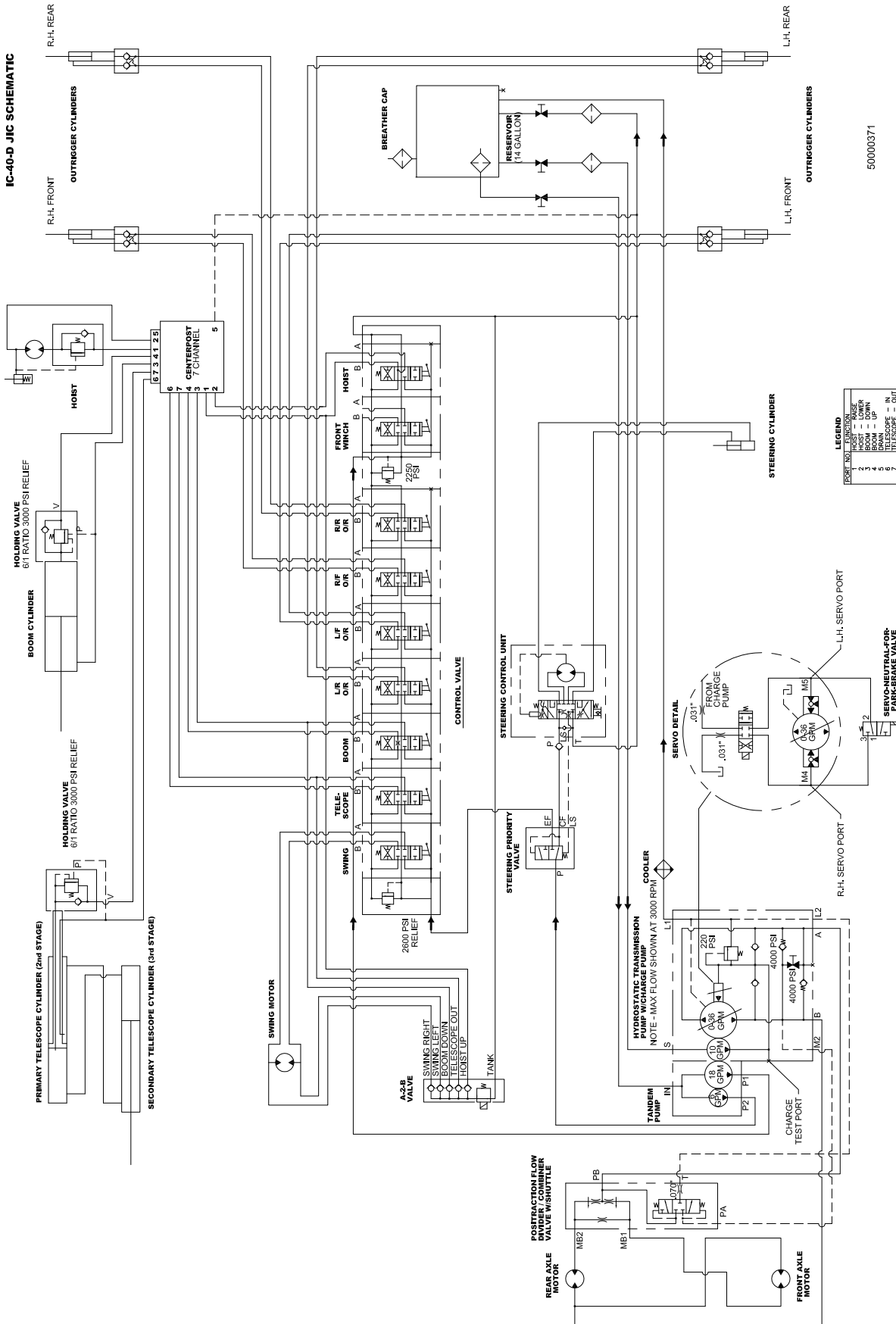

50000371

JIC SCHEMATIC METRIC

IC-40-D JIC SCHEMATIC - METRIC

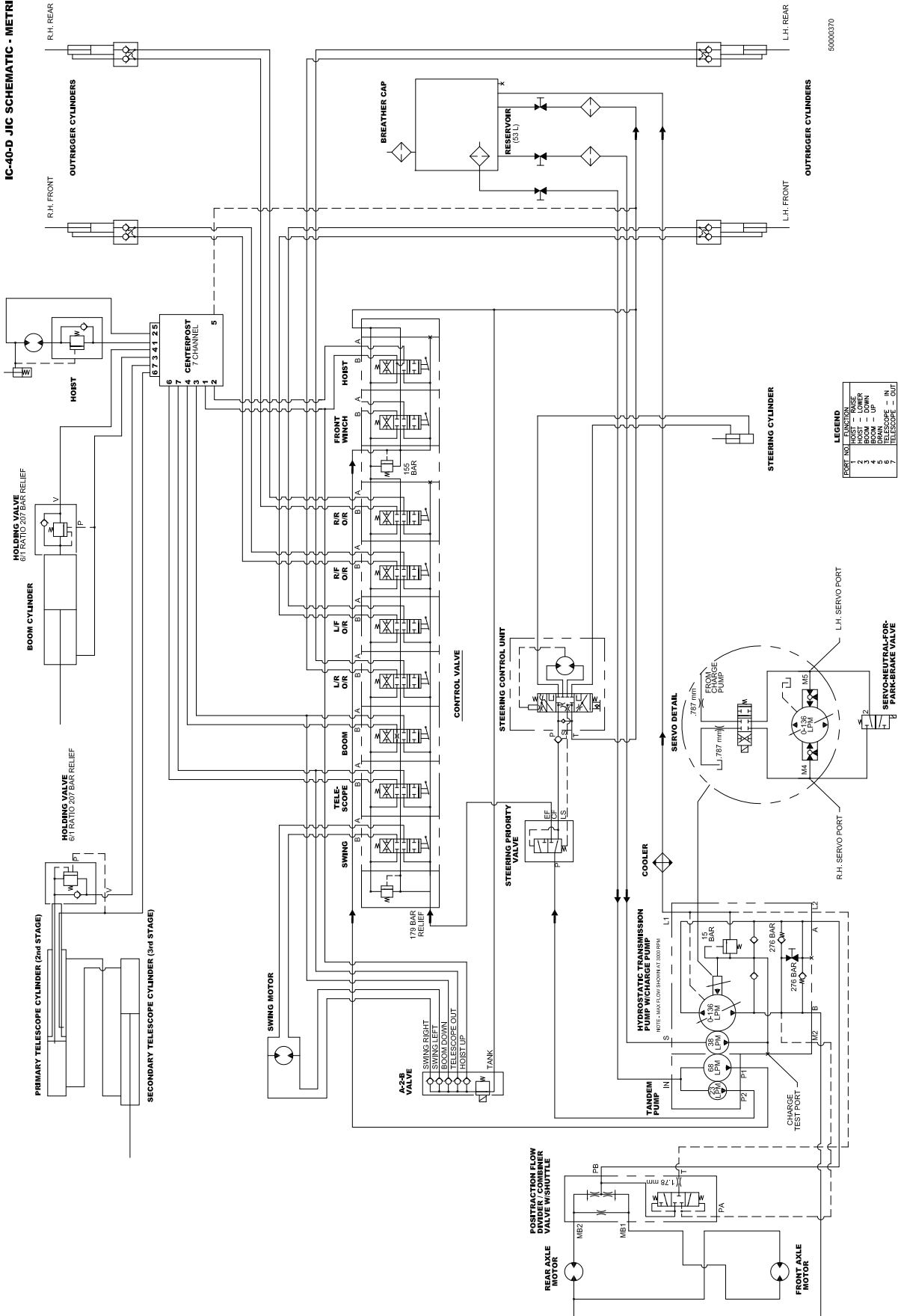

50000370

HYDRAULIC SYSTEM

The IC-40 hydraulic system consists of 3 sub-systems, driven by a triple pump. The 36-GPM (136 L/min) piston pump powers the propulsion system. The 6-GPM (23 L/min) gear pump supplies the hydrostatic steering function, and the boom & outrigger functions. The hoist and optional front winch are powered by the 18-GPM (68 L/min) pump.

The boom, outrigger and hoist functions are controlled by a single valve assembly with two inlet ports. The 6-GPM (23 L/min) pump flow enters the left-hand port and supplies the swing, boom, telescope, and outrigger sections. The 18-GPM (68 L/min) pump flow enters the mid-inlet port to supply the hoist. Adjustment procedures for the crane hydraulic functions are given on page 3-25.

The schematic of the hydraulic system is shown on the page 3-12. The steering system and propulsion systems are also shown in diagrams on the following pages.

STEERING SYSTEM

The IC-40 steering system is a load-sensing, demand-type system that takes only as much flow as is needed when steering, and directs the excess flow to the control valve for boom & outrigger functions. The priority flow-control valve is in the line between the 6-GPM (23 L/min) pump section and control valve.

Oil from the 6-GPM (23 L/min) section of the pump goes into the priority valve at port "P." When no steering is required, the entire flow goes through the priority valve and leaves through port "EF" to the crane valve. The crane operating speed is not affected, since there is no loss of volume passing through the priority valve.

When the steering wheel is turned, the load-sensing line signals the priority valve to divert the required amount of oil to the steering control unit, to meet the steering system requirements. The excess oil, not required for steering, flows to the crane control valve as usual. Since the amount of oil required for steering is usually a small portion of the pump output, the crane control valve is always operational while the unit is being steered. Crane operation speed is reduced such a slight amount, it is usually not noticed.

The steering control unit is non-load-reactive. This means that bumps, curbs, and obstacles cannot change the steering angle and are not felt in the steering wheel. It also means that the wheels do not re-center when the steering wheel is released. The steering wheel must be turned back to center at the end of a turn.

The steering system pressure relief valve inside the priority valve is set at 1400 PSI (97 bar) at the factory, and should not need adjustment. The three steering modes are selected by a switch on the dashboard, which activates the automatic alignment system. Electronic proximity sensors and logic controls delay the switching of the steering mode until the wheels are centered. The proximity sensors should be cleaned periodically with a rag to prevent dirt build-up from blocking their operation.

STEERING SYSTEM

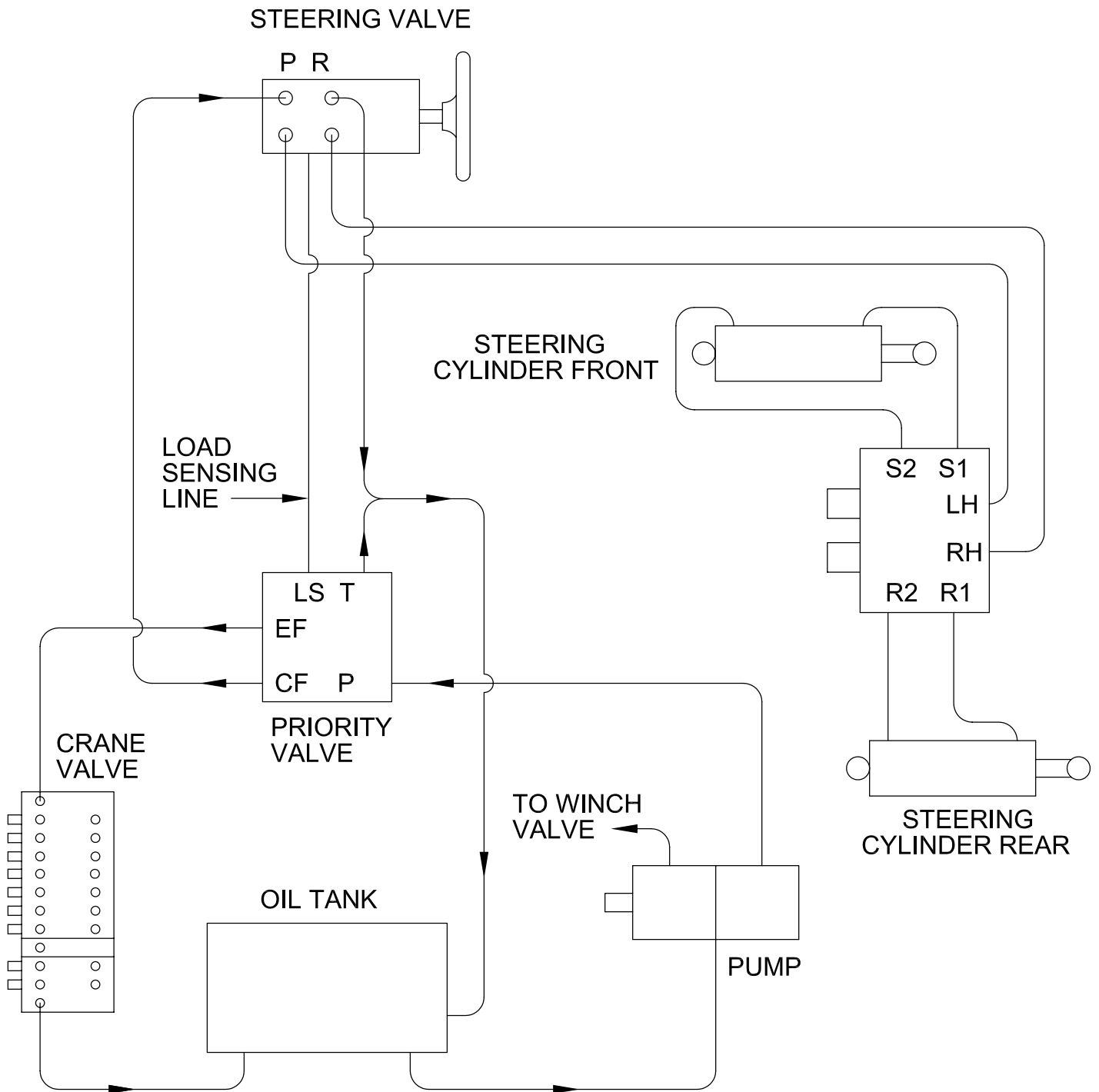

PROPULSION SYSTEM

The propulsion system is a closed-loop hydrostatic transmission. The variable volume piston pump is driveline driven from the engine crankshaft. The pump can deliver up to 34 GPM (129 L/min) or 4000 PSI (276 bar) to the wheel drive motors. The flow from the wheel drive motors returns directly to the pump inlet, not the reservoir. The built-in charge pump maintains approximately 220 PSI (15 bar) of pressure to the intake side of the piston pump whenever the engine is running. Excess flow from the 9-GPM (34 L/min) charge pump combines with case drain flow, goes through the cooler, and returns to tank.

When the transmission control switch in the operator compartment is in FORWARD, and the accelerator pedal is depressed, the pump starts delivering oil to the wheel drive motors for forward travel. When the accelerator is released, the pump blocks the flow and the wheel drive motors stop. If this is done on level ground, the crane will stop and stand still. If this is done on an incline, the crane will stop, but then creep down the incline, due to oil leaking through the wheel drive motors. ALWAYS apply the parking brake when the crane is stopped. When parking on a slope, also set the outriggers or place wheel chocks on the downhill side of the wheels.

A positraction flow divider is located in the line between the pump and drive motors. When a wheel is lifted off the ground, is on ice, or for any reason starts to spin, it will momentarily take more oil than the wheel that has traction. When this happens, a spool inside the positraction valve will shift and restrict the high flow to the spinning wheel, forcing flow to the wheel with traction. If the unit stops moving, the engine speed will have to be increased to resume travel.

The crane is equipped with an oil cooler that will allow it to operate properly when the ambient temperature is slightly over 100°F (38°C). An oil temperature gauge is provided just ahead of the steering wheel. The sensor for this gauge is located in the return line to the oil tank. If this gauge reads above 200°F (93°C), the unit should be shut down and the reason for the excessive temperature located and corrected. The fins on the oil cooler and engine radiator may be dirty and need cleaning.

The transmission speed is controlled by an electronic circuit that senses engine speed and signals the transmission pump to deliver a proportional flow of oil to the wheel drive motors. There is a manual operator lever on the control coil of the pump for testing.

A manual bypass valve is built into the piston pump. It appears like a shaft with a cross hole in it on the side of the pump. If the machine cannot run under its own power, it can be towed for very short distances at 5 MPH (8 km/h) or less by turning the bypass valve counterclockwise 4 turns. It must be turned back again as far as possible to run normally.

CAUTION: The crane will roll freely down inclines with the bypass valve open. Keep the valve closed except when towing and when the crane is secured to the tow vehicle. An operator must be in the crane to operate the brakes.

IC-40 PROPULSION SYSTEM

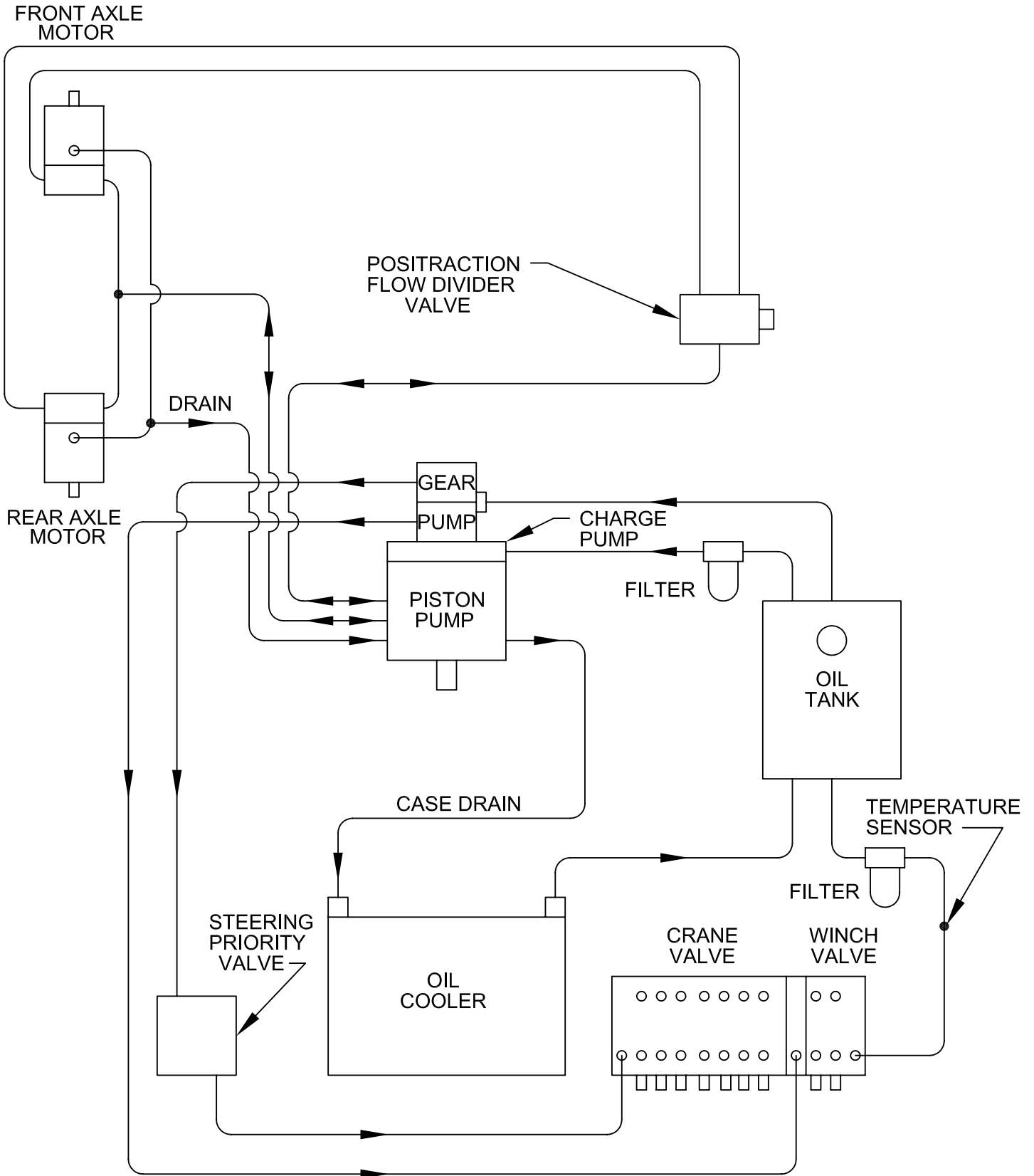

START-UP PROCEDURE -- PISTON PUMP

When initially starting a new or rebuilt transmission pump, it is extremely important that the start-up procedure be followed. It prevents damaging the unit that might occur if the system is not properly purged and charged with oil before start-up.

1. After the propulsion components have been properly installed, fill pump housing at least half full with new hydraulic fluid, as specified on page 3-21. Connect all hydraulic lines and check to be sure they are tight.
2. Check the wiring connections to the pump control.
3. Fill the reservoir with approved hydraulic fluid that is new and clean. Install a 0 to 300 PSI (0 to 20 bar) gauge in the charge pressure port. The port is the highest port on top of the pump and has a #6 elbow with a 1/4" hose that connects with the brake release valve. This may be disconnected, or a tee may be inserted. See figure below.
4. **Gasoline or L.P. Engines:** Remove the coil wire and turn the engine over for 15 seconds. **Diesel Engines:** Shut off the fuel flow to the injectors and turn the engine over for 15 seconds. This procedure enables the charge pump to pick up the oil before start-up.
5. Replace the coil wire or return the fuel flow to the injectors. Keep the transmission control switch in the neutral position, start the engine, and run it at a low idle. The charge pump should immediately pick up oil and fill the system. If there is no indication of fill in 30 seconds (gauge in charge pressure port of the pump should register about 220 PSI (15 bar)), stop engine and determine the cause.

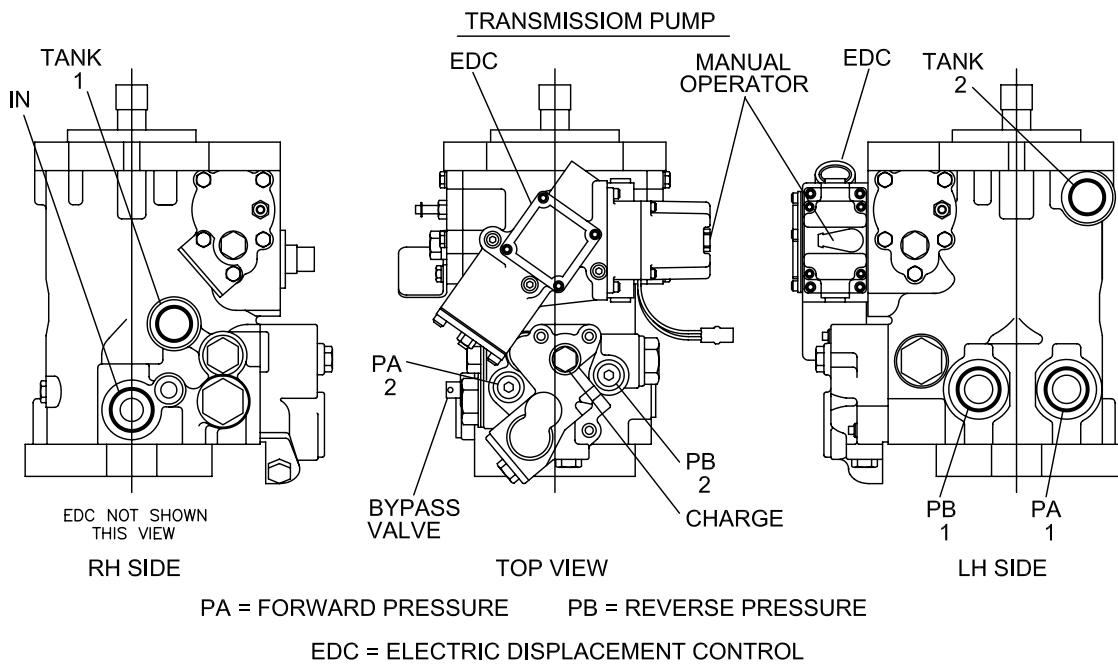

6. After the system shows signs of filling, run it in neutral and low idle for 5 minutes. Then extend the outriggers so that drive wheels can spin freely. Reconnect the brake release valve if disconnected in step 3. Place the control switch in the FORWARD position and slowly push the accelerator until the wheels turn slowly. Run for 5 minutes and repeat in reverse direction. Then increase to full throttle for one minute in each direction.
7. Check fluid level in the reservoir and fill to the proper level. Check all line connections for leaks and tighten if necessary.

IC-40 PISTON PUMP TROUBLESHOOTING

TROUBLE	CAUSES	REMEDIES
1. System will not operate in either direction.	A. Brake switch tripped	Release brake switch.
	B. Oil supply low	Check oil level, fill.
	C. Oil filter clogged	Replace filter element.
	D. Oil too heavy	Use proper viscosity oil.
	E. Bypass valve open	Close bypass valve.
	F. Bad electrical connection	Check all related connections.
	G. Circuit breaker open	Fix short, overload or breaker.
	H. Defective switch	Replace switch.
	I. Defective RPM sensor	Fix or replace sensor.
	J. Defective controller circuit	Replace controller circuit.
	K. Defective pump solenoid	Replace pump solenoid.
	L. Defective brake release solenoid	Fix or replace solenoid or wiring.
	M. Low charge pressure--below 200 PSI	See below: N, O, P,Q.
2. Pump is noisy.	N. Charge pump relief valve damaged	Remove relief valve parts. Examine parts and seat. Replace damaged parts.
	O. Damaged internal charge check valve	Disassemble and determine if check valve is faulty.
	P. Charge pump key sheared	Inspect charge pump for damage & replace key.
	Q. Charge pump worn or scored or damaged	Remove parts and examine. Replace defective parts. If severe scoring is indicated, remove complete pump unit, disassemble and inspect for damage.*
	R. Drive coupling broken	Inspect coupling for sheared spline.
	S. Forward or reverse relief valve stuck open	Remove relief valve. Clean or replace.
3. Sluggish response to acceleration or deceleration	A. Air in system	Fill oil reservoir. Check and fix suction line leaks.
	B. Clogged filter	Replace filter element.
	C. Internal pump or motor wear or damage	Disassemble, inspect and repair.*
	A. Air in system	See Steps 1-B, 1-D, 2-A.
	B. Low charge pressure	See Step 1-L.
E. Relief valve dirty or damaged	C. Loose bypass valve	Close bypass valve.
	D. Internal pump or motor wear or damage	Disassemble, inspect and repair.*
	E. Relief valve dirty or damaged	Remove, clean or replace.

* Pump should be disassembled only by experienced hydraulic pump repair personnel, preferably at a Sauer Danfoss Service Center.

CARE OF HYDRAULIC OIL

The hydraulic system contains many highly pressurized, precision components. To protect these, it is very important to keep the hydraulic oil clean, at proper temperature, within the oil specification, and to the proper fill level.

The IC-40 is equipped with a 100-mesh suction strainer, a 10-micron suction filter, a breather filter, a 10-micron return-line filter, and a 14-gallon (53 L) tank. The filters must be changed after the first 100 engine hours to eliminate the contaminants generated during run-in. Thereafter, they are to be changed at every 500-hour maintenance interval.

The filters are located under the deck cover. Clean the filter and the surrounding parts with steam or pressure washer before changing, to prevent dirt from falling into the clean oil tube. To minimize oil loss, close the shutoff valves under the tank. **Be sure shutoff valves are fully opened before starting engine.**

Remove the filter elements and catch the hydraulic oil in a clean container. Pour the remaining oil out of the old elements into the clean container and inspect the oil for water and excessive contaminants. If water is found, the oil should be changed in the reservoir and purged out of the cylinders. If excessive particles are found, the source should be located and fixed, and the oil should be purged.

Lubricate each new element seal and install the new elements. Open the shutoff valves. Run the engine and check for any leaking around the seals.

The hydraulic oil should be changed every 1000 hours, or once a year, whichever is sooner. Wash the oil tank and filters before changing the oil. Retract the telescope, boom lift, and outrigger cylinders. Leave the shutoff valves open and remove the drain plug. Catch the oil and dispose of it properly. Clean the breather element in the fill cap with solvent and compressed air. Clean out the tank with solvent and compressed air.

Replace the filters, as described previously, and refill the tank with new hydraulic oil that meets the specifications in the table below. Start the engine and run it at low idle for 15 minutes to filter the new oil. Then cycle all of the hydraulic cylinders at low idle and low pressure. Add hydraulic oil to the dipstick level mark, if necessary, with cylinders retracted.

APPROVED HYDRAULIC FLUIDS

WARM CLIMATE:

*D-A AUTOTRANS SUPER PLUS
MOBIL MULTI-VEHICLE A.T.F.
DEXRON VI

COOL CLIMATE:

MOBIL MULTI-VEHICLE A.T.F.
DEXRON VI

* *D-A Lube, Autotrans Super Plus*, was used at the factory to fill the hydraulic system of your IC-40.

CAUTION

Never add kerosene or other "thinners" to hydraulic oil. These fluids have low aniline points and consequently will cause rapid deterioration of certain packings and seals in the hydraulic system.

CAUTION

Serious damage to the pumps will result if they are run with the shutoff valves closed or with insufficient oil level in the reservoir.

Observe the operation of the machine. If the oil is too cold, the machine will be sluggish and should be warmed up further before sustained hard work is attempted. If the oil is too hot, leakage will increase, pump efficiency will go down, and moving parts will not be properly lubricated. If operating temperature is excessive, rapid deterioration of the oil will result and moving parts & seals will wear more quickly. The cause of the excess heat should be determined and corrected. Oil temperature should never exceed 200° F (93° C).

PURGING THE HYDRAULIC SYSTEM

If excessive water or other contamination is found in the hydraulic oil, the source should be found and fixed, and the oil should be changed. However, there will still be contaminated oil in the hydraulic cylinders. This oil should be purged by the following procedure:

1. Drain the reservoir, open the three gate valves under the reservoir, and remove the two filter elements & the strainer.
2. Disconnect the following hoses: The four hoses at the reservoir, the return hose at the inlet of the smaller filter, the case drain hose at the hydrostatic transmission piston pump, the two pressure hoses at the double gear pump, and the two pressure hoses at the right-hand wheel motor.
3. Allow the oil to drain from the hoses and be careful to prevent dirt from getting in the hoses.
4. Blow out the oil cooler with compressed air, through the hoses attached to it.

5. Clean the reservoir & strainer and replace the filter elements & hoses, except the return hose at the inlet of the smaller filter, and the case drain hose at the hydrostatic pump.
6. Attach a 3/4-inch I.D. return hose at the hydrostatic pump case drain port, and run it into a waste oil sump or barrel. Also run the return hose disconnected from the smaller filter into the waste oil sump or barrel. Do not plug these hoses.
7. Close the small gate valve under the reservoir and plug the case drain hose that is disconnected from the hydrostatic transmission pump. Leave the two large gate valves open.
8. Fill the reservoir with clean oil. Do not start the engine or move any controls until the proper point in this procedure. If the piston pump has been removed and replaced or repaired, follow the start-up procedure on page 3-18.
9. Monitor the oil level and do not allow it to fall below 5 inches (127 mm) from the top of the fill neck during this procedure.
10. Run the engine at low idle during this procedure to minimize oil loss and the possibility of pump damage from cavitation, due to low oil level.
11. Start the engine and run at low idle for about 10 seconds after flow starts from both return lines into waste oil sump. This should purge the pressure and return lines. Stop the engine.
12. Remove the extra hose from the piston pump case drain, reconnect the regular case drain line, and fill the reservoir.
13. Leave the return hose disconnected from the small filter and leave it in the waste oil sump.
14. Run the engine at low idle and turn the steering wheel fully to the right, fully to the left, and then back to straight. Stop engine.
15. Be sure the outriggers are all clear. Push both outrigger levers fully forward and run engine until the outriggers are fully extended. Stop the engine.
16. Release the levers.
17. Reconnect the return hose. Fill the reservoir and be sure all shutoff valves are open. Run the engine at low idle for 15 minutes to filter the oil.
18. With the front wheels off the ground, set the transmission control switch to FORWARD and push the accelerator gradually, until both wheels are turning slowly.
19. Run both wheels slowly, for 5 minutes. Then switch to REVERSE and run both wheels slowly in reverse for 5 minutes. Run the wheels at full speed in both directions for 1 minute.

20. Position the crane so that the boom may later be fully topped up, rotated, and extended. Do not operate these functions until the proper step.
21. Close the small gate valve in the return line and disconnect the return hose from the return filter inlet again. Run the hose into the waste oil sump. Shutoff valves in the suction lines must be open.
22. Pull the BOOM RAISE lever fully back in the RAISE position and start the engine. Run at low idle until the boom is fully topped up, then stop engine quickly.
23. Pull the SWING lever fully. Run the engine for 3 seconds and stop engine.
24. Release SWING lever, push HOIST lever to full LOWER position and run engine for 7 seconds, then stop engine.
25. Fill hydraulic reservoir.
26. Remove the hook from the load line and pull load line out of the boom tip.
27. Push TELESCOPE lever fully forward in the EXTEND position. Run the engine until the boom extends fully, then stop engine.
28. Reconnect the return hose. Be sure all shutoff valves are open.
29. Retract the boom and fill the reservoir.
30. Run engine and cycle all of the cylinders in and out several times.

HYDRAULIC SEALS

WARNING

Do not check for hydraulic leaks with hands. If a mist of hydraulic oil is noticed around a line or component, use cardboard or other material to check for location of leak. High pressure fluid leaking from a small hole can be almost invisible, yet have enough force to penetrate the skin. If injured by escaping fluid, see a doctor at once. Serious reaction or infection can occur.

All hydraulic fittings and hose connections should be kept tight to prevent loss of fluid from the system and unnecessary dripping from the machine. Most hydraulic fittings on the **IC-40** crane use o-ring seals, and if tightening the fitting fails to stop the leak, the o-ring should be replaced.

Notes:

1. When installing an o-ring fitting with an adjustable nut and washer, be sure to back off the nut, washer, and o-ring as far as possible before threading the fitting into the port. Then turn the fitting into the port as far as possible with fingers, and turn it backward until it is oriented properly. Torque the nut with a wrench, while holding the fitting with a wrench.
2. Lubricate all seals before assembling.
3. Take care not to over tighten pipe threads.
4. Do not use Teflon tape to seal pipe threads. Loctite-type (anaerobic) sealant is preferred.

Leaks in component parts, such as pumps, valves, and motors, that cannot be stopped by tightening bolts, can usually be stopped by replacing the seals in the component. Seal and packing replacement is the only maintenance which owners should attempt on component parts, unless they have a well-equipped shop with mechanics trained in hydraulic component overhaul.

Leakage in the pump suction line may not cause oil to appear externally, but may allow air to enter the line during operation. The air entrapped in the oil will cause pumps to be noisy, and if allowed to continue, can damage the pump. If a pump becomes noisy, immediately check the fluid level in the reservoir and be sure all suction fittings are tight. If noise continues, squirt hydraulic fluid on the suction connections. Listen for a change in the noise and watch for oil being sucked into a small opening in the connection. When the reservoir is full, the shutoff valve is open, and all suction connections are tight, most pump noises will disappear. If they do not, a worn or faulty pump is indicated. On a routine basis, all hoses should be checked for wear, deterioration, and physical damage. Defective hoses should be replaced for maximum economy for the user.

CONTROL VALVE ADJUSTMENTS

The crane control valve has two relief valves to protect the hydraulic components. The relief valves are adjustable and should be checked and set as follows:

1. Boom and outrigger circuits -- 2600 PSI (179 bar) at full flow.
2. Hoist circuit -- 2250 PSI (155 bar) at full flow.

BOOM AND OUTRIGGER CIRCUITS:

Remove the 3/8-inch tube cap from the test fitting on the left-hand side of the control valve and install a 3000 PSI (200 bar) test gauge. To obtain full flow reading, run pump at full speed and actuate BOOM control lever to LOWER position, and hold until maximum reading is made. If a pressure of 2600 PSI (179 bar) is not possible, check the following:

1. Low oil level in the reservoir.
2. Clogged suction filter or shut-off valve not fully opened.
3. Valve spool linkage not allowing control valve to fully open. Valve spool should move 5/16 of an inch (8 mm) each way from neutral.
4. Adjust relief valve by removing cap on end of relief cartridge, and turning socket head screw clockwise to increase pressure, or counter-clockwise to lower pressure.
5. Foreign particle in pilot-operated relief.
6. Broken mechanical connection to the pump shaft.
7. Worn or defective hydraulic pump.

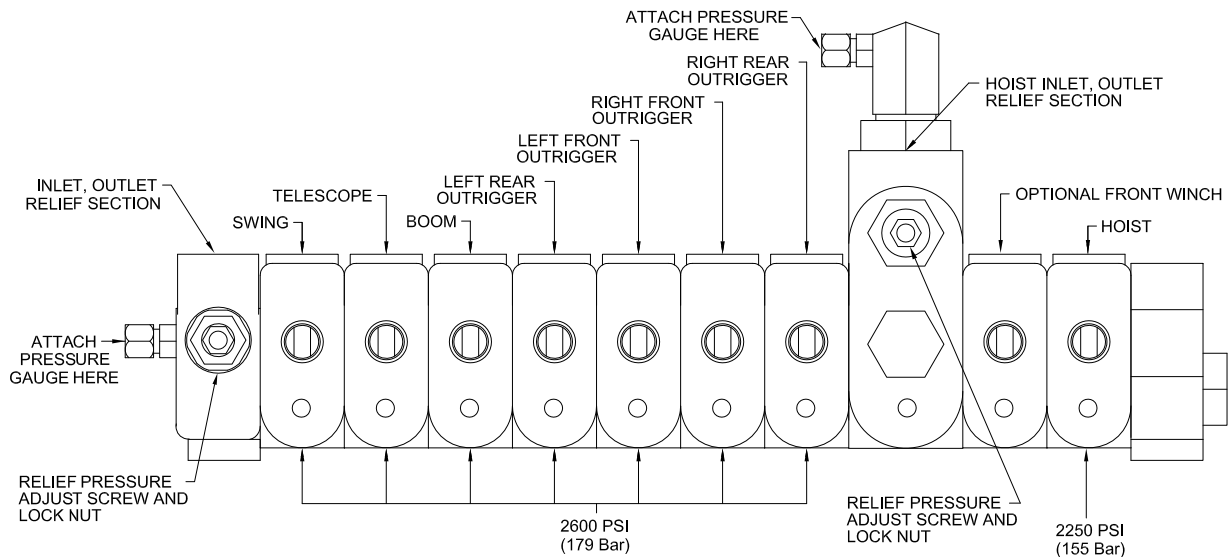

HOIST CIRCUIT:

The relief pressure for the hoist valve can be adjusted similarly to the boom circuit. Connect a 3000 PSI (200 bar) gauge to the test fitting on the mid-inlet section of the valve. Disconnect both hoses at hoist motor and install plugs. Do not connect hoses together. Operate hoist control in either direction. Run engine at full throttle. Adjust relief valve to 2250 PSI (155 bar) at full flow.

BOOM CYLINDER HOLDING VALVE

A holding valve is built into the base of the boom lift cylinder barrel. This valve is designed to hold the boom in position should loss of power or pressure line failure occur.

To check the boom lift cylinder holding valve, set the outriggers, place the boom in the horizontal position over the front of the crane, and raise rated load about one foot above the ground, using the boom lift cylinder (not the hoist). An example of rated load for the IC-40-2D is 4150 pounds (1830 kg), at an 8-foot (2.5 m) load radius, with outriggers extended, and the boom over the front. Turn the engine off and move the BOOM lever to the LOWER position. If the boom moves down, adjust the holding valve.

WARNING

Before working on the holding valves or plumbing to the boom cylinders, always relieve trapped pressure by lowering the boom fully, turning off the engine, and cycling the BOOM and TELESCOPE lever.

To adjust the holding valve, loosen the jam nut on the adjusting screw and tighten the screw one-half turn and retest. Repeat until unpowered boom movement stops. Retighten the jam nuts. If adjusting the valve does not help, the cylinder may have internal leakage or the valve may be malfunctioning.

EXTENSION CYLINDER HOLDING VALVE

A holding valve is directly connected to the base of the primary extension cylinder rod. The valve is designed to hold the boom in position should loss of power or pressure line failure occur.

The holding valve should be checked with the boom elevated to the maximum angle and the boom extended to a 4-foot (1.2 m) load radius. An 8,000 pound (3630 kg) load on a two-part line is required for this test. Use the hoist to lift this load about six inches (15 cm) above the ground. The radius of the test load should be within the rating on the capacity chart. Use great care to prevent the load from hitting the crane.

Turn the engine off and pull the TELESCOPE lever to the RETRACT position. If the boom retracts, the valve should be adjusted.

To adjust the holding valve, loosen the lock nut on the adjusting screw and tighten the screw until unpowered movement stops. Retighten the lock nut to hold the proper adjustment.

AIR CLEANER SERVICE:

Clean out the dust cup every 50 hours. Loosen the clamps around the cup & housing, and remove the cup. Dump dust out of cup. Clean gasket and sealing surfaces with a damp cloth. Replace cup gasket if it shows signs of damage. Replace cup with arrows pointing up and tighten clamp.

Clean the intake cap screen every 50 hours, and perform a thorough inspection of the air intake pipes and joints.

Clean the filter element every 250 hours or every 3 months, (whichever comes sooner) and replace the element every 500 hours or 6 months. Remove and clean the dust cup & gasket, and the intake cap. Remove the wing nut on the element and gently remove the element. Bumping the element during removal may cause dirt to fall into the clean air tube. Clean the inside of the housing carefully with a damp cloth. To clean the element, use a compressed air blower nozzle with less than 100 PSI (7 bar) and blow air from the inside of the element. Shake dust off of the outside of the element. Make sure the gaskets and element fit properly and reassemble, being careful not to allow any dust into the intake pipe.

Do not remove an element just for inspection. This may do more harm than good. You cannot judge the element condition by its appearance. If you think the filter may need service, remove it and replace, or clean it before reassembling air cleaner.

Conditions where more dirt than usual is in the air, especially soot, will make frequent service more necessary. If there is a significant amount of dust in the dust cup when it is cleaned every 50 hours, clean the element every 100 hours and replace it every 200 hours--or more frequently in extremely dusty conditions. Excessive exhaust smoke or loss of power may indicate a plugged filter.

COOLING SYSTEM:

Check the level of coolant in the radiator overflow tank daily. Add a mixture of antifreeze and distilled water to the overflow tank, as required, to maintain the coolant level. Check the radiator fins for dirt or debris daily, and wash the fins with a pressure or steam cleaner every 50 hours (or as required). Check the antifreeze protection level every 500 hours. Every 2 years, flush the cooling system and replace the thermostat and coolant. Pressure test the system as specified by the engine manufacturer.

SPARE PARTS LIST:

A spare parts list (including oil filter, fuel filter, etc.) may be found in the *Parts Manual* under *Engine Installation*. Replace engine parts only with genuine OEM parts, as required by EPA regulations.

MAJOR ENGINE SERVICING OR OVERHAUL:

Major servicing or overhaul is beyond the scope of this manual. Consult authorized engine service manual or rely on an authorized engine service center.

MECHANICAL ADJUSTMENTS

FASTENERS:

All fasteners in the **IC-40** should be checked and retightened, if required, as a part of the preventive maintenance program. Particular attention should be given to the axle, wheel & hub mounting bolts, pump mounting bolts, rotation bearing bolts, rotation gearbox bolts, and hoist bolts. All bolts used in assembly are heat-treated Grade 5, except the wheel bolts and the bolts attaching the rotation bearing to the mainframe and turret, which are Grade 8. Torque the rotation bearing mounting bolts to 200 ft-lbs (270 N-m). Torque the wheel nuts to 500 ft-lbs (680 N-m). The torque chart on the next page can be used on all other bolts.

ROTATION GEARBOX:

The rotation gearbox assembly is attached to the chassis top plate by four capscrews. It is held in proper engagement with the external teeth on the bull gear by two jackscrews in front of the gearbox. It is further restrained from torsional movement by four bolts at the sides of the gearbox. Proper adjustment exists when there is .010-inch (.25 mm) backlash between the pinion and bull gear teeth. If adjustment is required, loosen the gearbox mounting bolts and the side bolts. Tighten the two front jackscrews until proper adjustment is obtained. Tighten the mounting bolts and the side bolts. Lock jackscrews and bolts into position.



WHEEL BEARING ADJUSTMENTS:

Wheel bearing adjustment must be maintained at all times. Adjustment is made each time the bearings are repacked (annually). Wheel bearings are adjusted by the adjusting nut. This nut should be tightened until only a slight drag is felt when rotating the wheel.

WHEEL ALIGNMENT:

Toe-in, which is the setting of the steering wheels so they are closer together at the front than at the rear, is adjusted by lengthening or shortening the tie rods. Proper toe-in for the rear wheels is zero.

TORQUE DATA

BOLT GRADE	SAE GRADE 1 OR 2	SAE GRADE 5	SAE GRADE 8
MARKING			
MATERIAL	LOW CARBON	MEDIUM CARBON STEEL Q & T	MEDIUM CARBON ALLOY STEEL Q & T
MINIMUM TENSILE STRENGTH	64,000 PSI (441 MPa)	120,000 PSI (827 MPa)	150,000 PSI (1034 MPa)
BOLT SIZE	RECOMMENDED TORQUE VALUES FT-LBS (N-m)		
1/4	5 (7)	7 (10)	10.5 (14)
5/16	9 (12)	14 (19)	22 (30)
3/8	15 (20)	25 (34)	37 (50)
7/16	24 (32)	40 (54)	60 (81)
1/2	37 (50)	60 (81)	92 (125)
9/16	53 (72)	88 (119)	132 (179)
5/8	74 (100)	120 (163)	180 (244)
3/4	120 (163)	200 (271)	296 (401)
7/8	190 (258)	302 (409)	473 (641)
1	282 (382)	466 (632)	714 (968)



THE FOLLOWING RULES APPLY TO THE CHART:

1. Consult manufacturers' specific recommendations when available.
2. The chart may be used with coarse and fine thread fasteners lightly lubricated.
3. Increase torque by 20% when multiple tooth (shakeproof) lockwashers are used.
4. The torque values are given in foot-pounds (N·m).
5. Inch-pounds equivalent may be obtained by multiplying by 12.

IC-40-D (GAS)

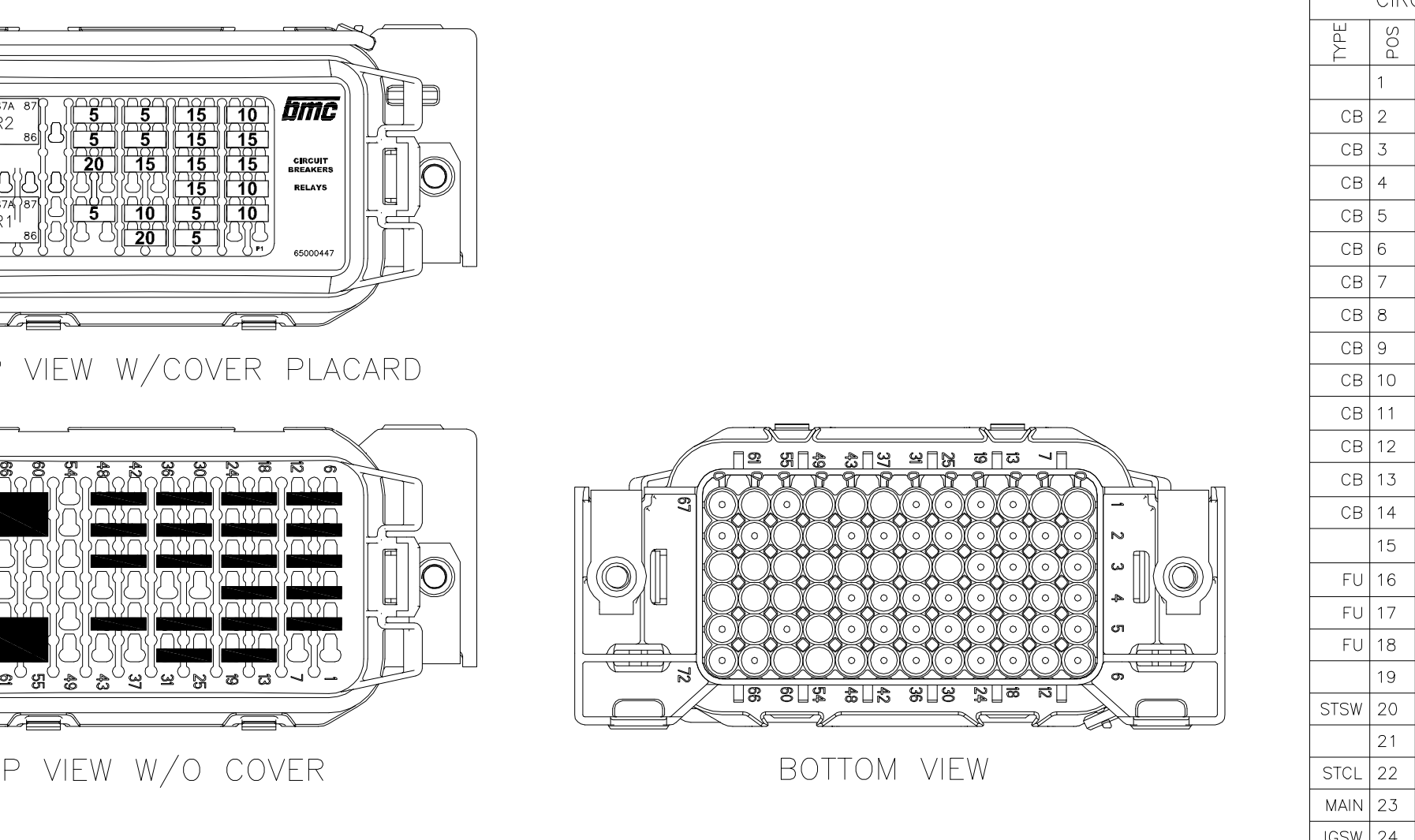
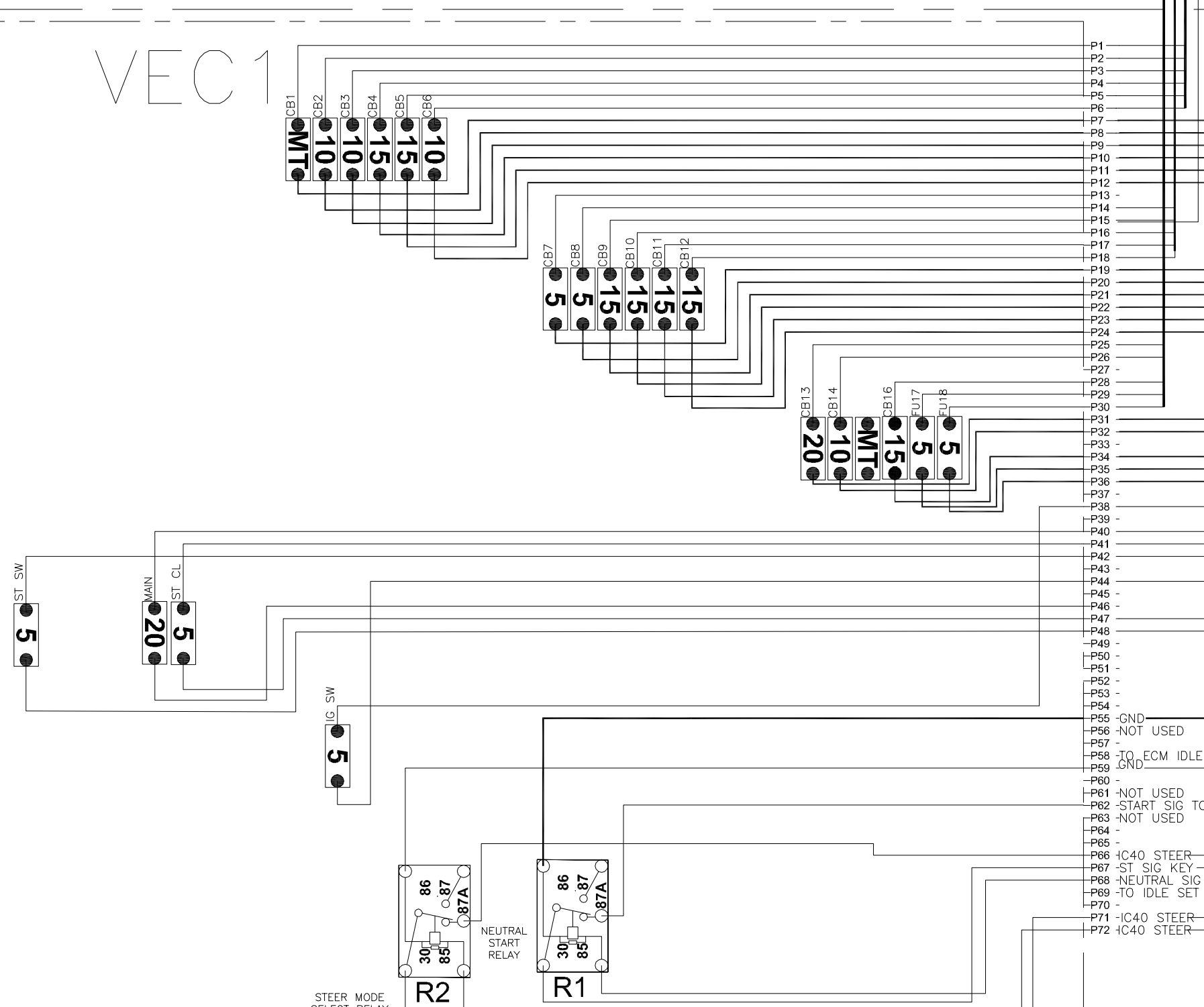
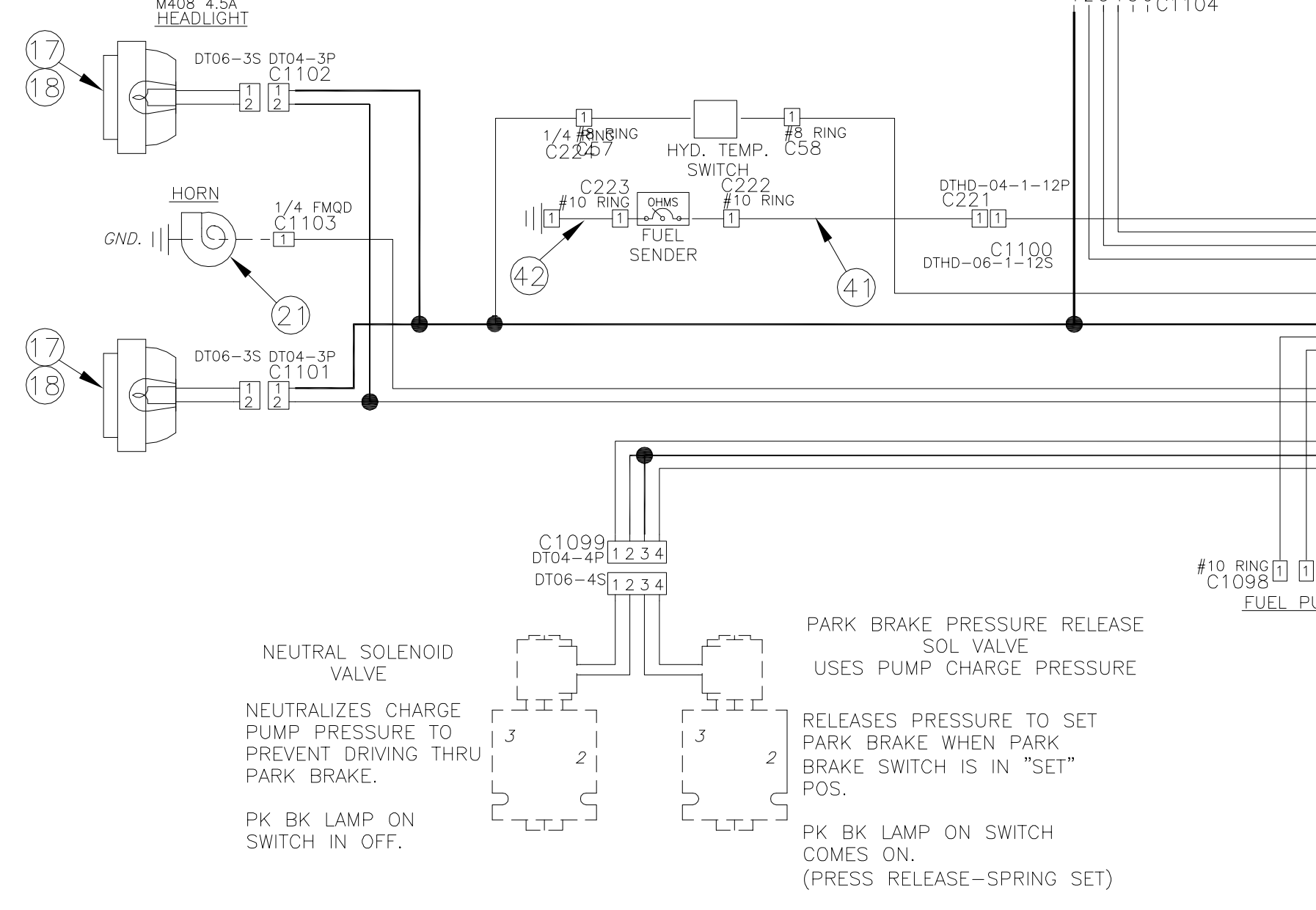
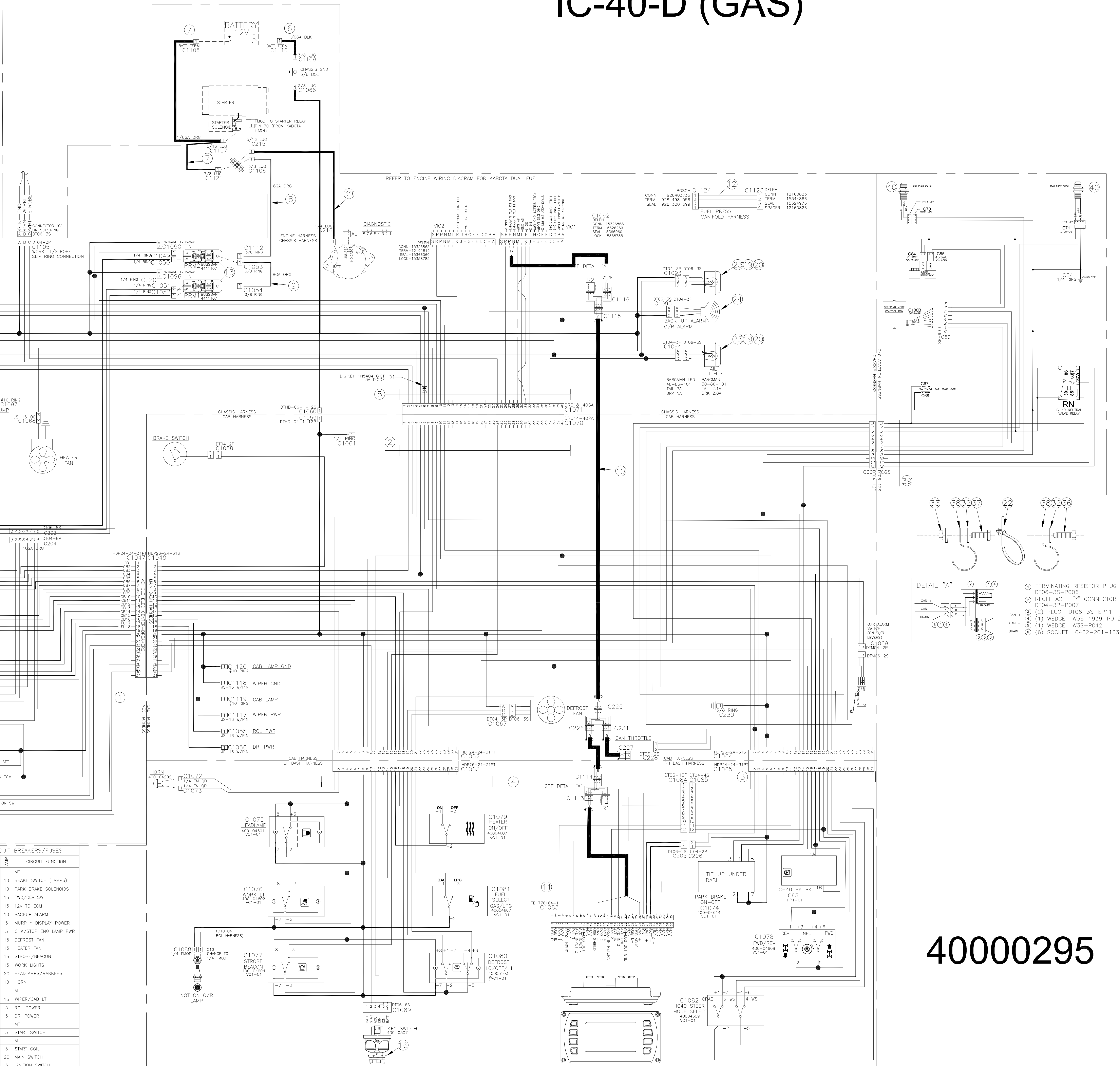
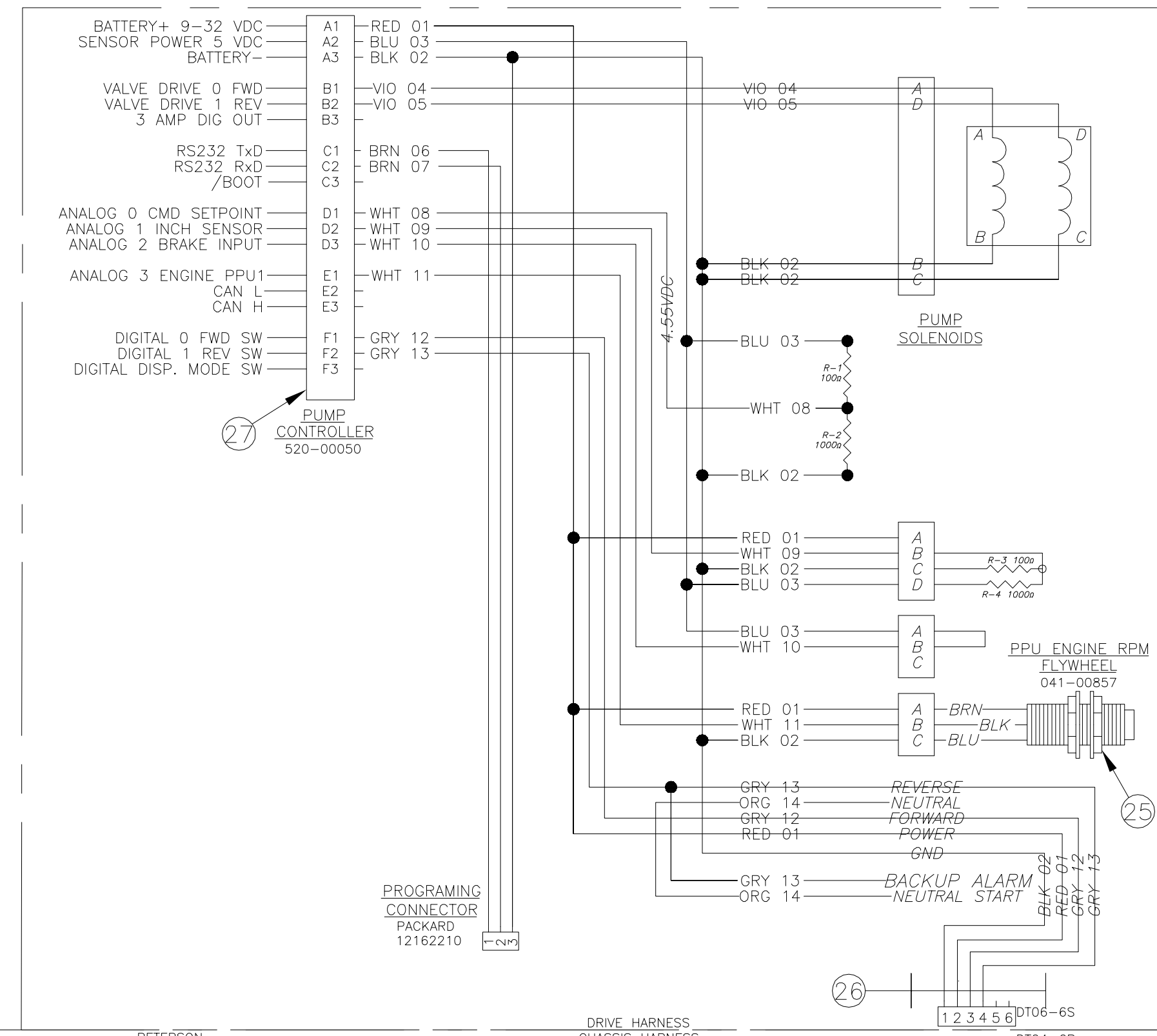

TYPE	PROT	AMP	CIRCUIT FUNCTION
1	MT		10 BRAKE SWITCH (LAMPS)
CB 2			10 PARK BRAKE SOLENOIDS
CB 3			15 FWD/REV SW
CB 4			15 12V TO ECM
CB 5			10 BACKUP ALARM
CB 7			5 MAIN/STOP LAMP POWER
CB 8			5 CHG/STOP ENG LAMP PWR
CB 9			15 DEFROST FAN
CB 10			15 HEATER FAN
CB 11			15 STROBE/BEACON
CB 12			15 WORK LIGHTS
CB 13			20 HEADLAMPS/MARKERS
CB 14			10 HORN
CB 15			15 WIPER/CAB LT
FU 16			15 WIPER/CAB LT
FU 17			15 RCL POWER
FU 18			15 DRI POWER
19			MT
STSW 20			5 START SWITCH
21			MT
STL 22			5 START COIL
MANL 23			20 MAIN SWITCH
IGSW 24			5 IGNITION SWITCH

40000295

IC-40-D (DIESEL)

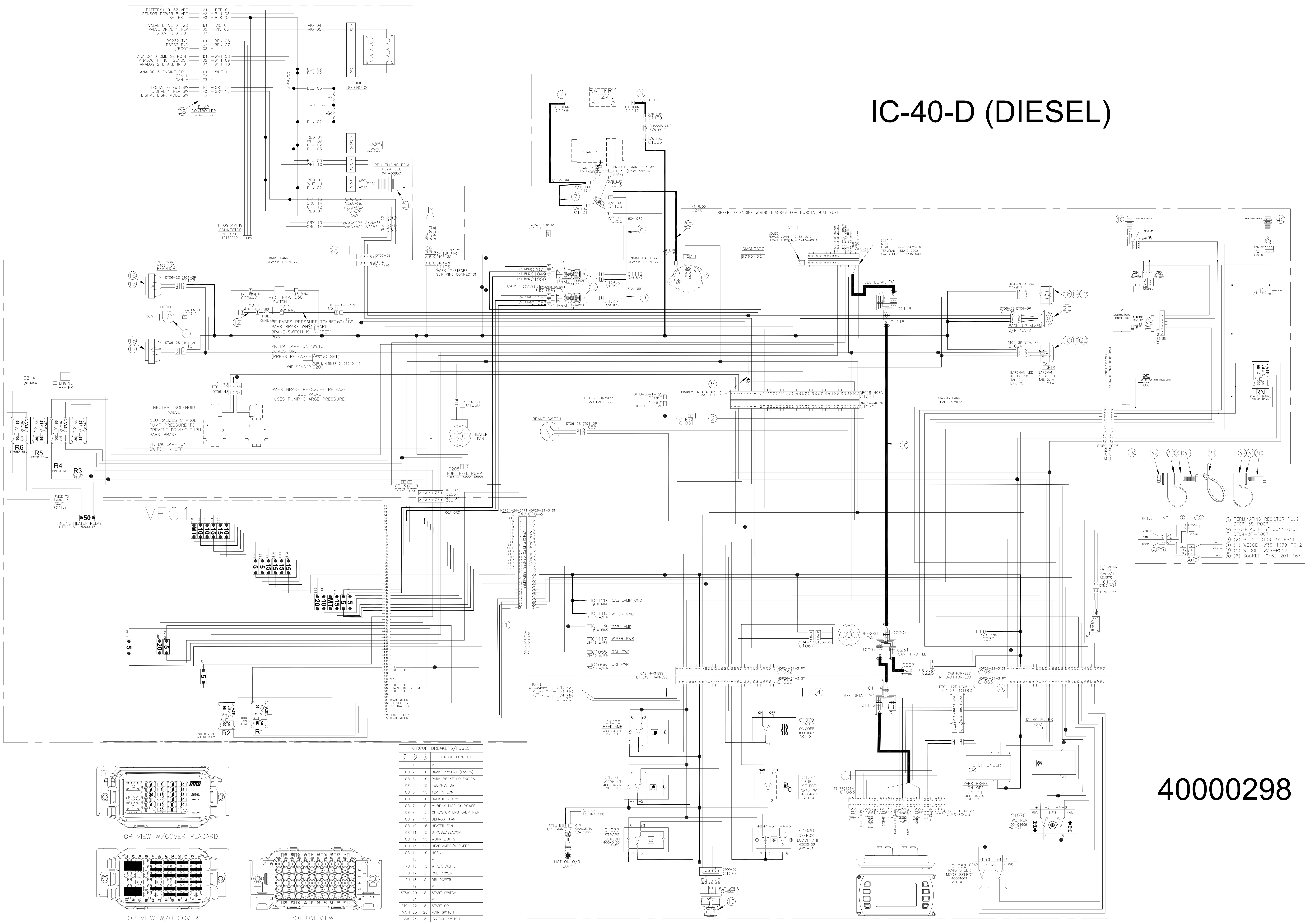

- DETAIL "A"**
- ① TERMINATING RESISTOR PLUG DT06-35-P006
 - ② RECEPTACLE "Y" CONNECTOR DT04-3P-P007
 - ③ PLUG DT06-35-EP11
 - ④ WEDGE W35-1939-P012
 - ⑤ WEDGE W35-P012
 - ⑥ SOCKET 0462-201-1631

TYPE	NO.	RAT	CIRCUIT FUNCTION
1	1	MT	MT
2	10	MT	BRK SW (LAMP)
3	10	MT	PARK BRK SOLENOIDS
4	15	MT	FWD/REV SW
5	15	MT	12V TO ECM
6	10	MT	BACKUP ALARM
7	5	MT	MURPHY DISPLAY POWER
8	5	MT	CHK/STOP ENG LAMP PWR
9	15	MT	DEFROST FAN
10	15	MT	HEATER FAN
11	15	MT	STROBE/BEACON
12	15	MT	WORK LIGHTS
13	20	MT	HEADLAMPS/MARKERS
14	10	MT	HORN
15	10	MT	MT
FU1	15	MT	WIPER/CAB LT
FU17	5	MT	RCL POWER
FU18	5	MT	DR POWER
19	10	MT	MT
STSW	20	MT	START SWITCH
21	10	MT	MT
STCL	22	MT	START COIL
MAIN	23	MT	MAIN SWITCH
10SW	24	MT	IGNITION SWITCH

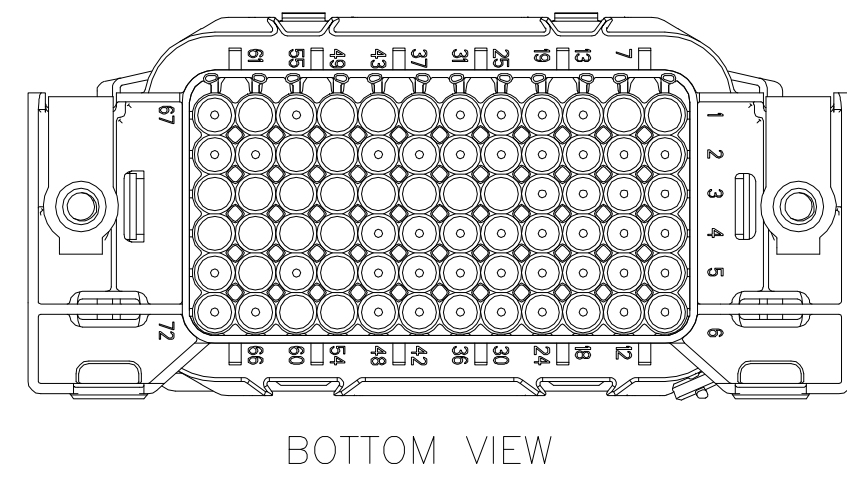
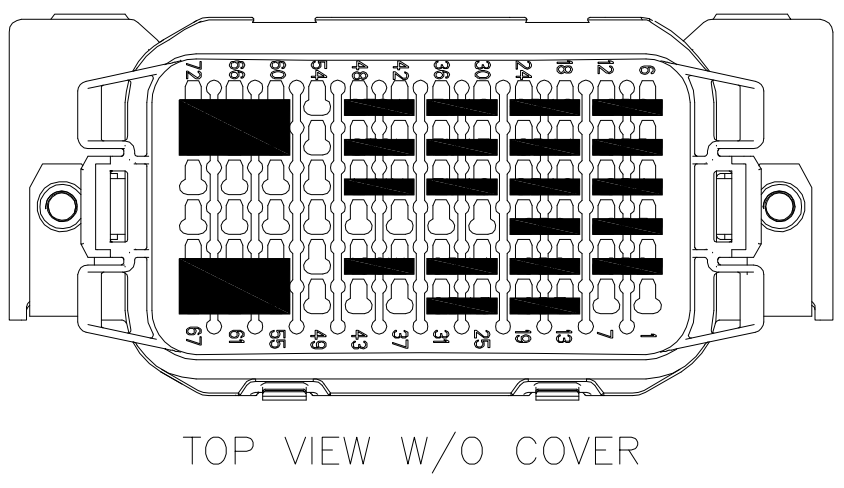
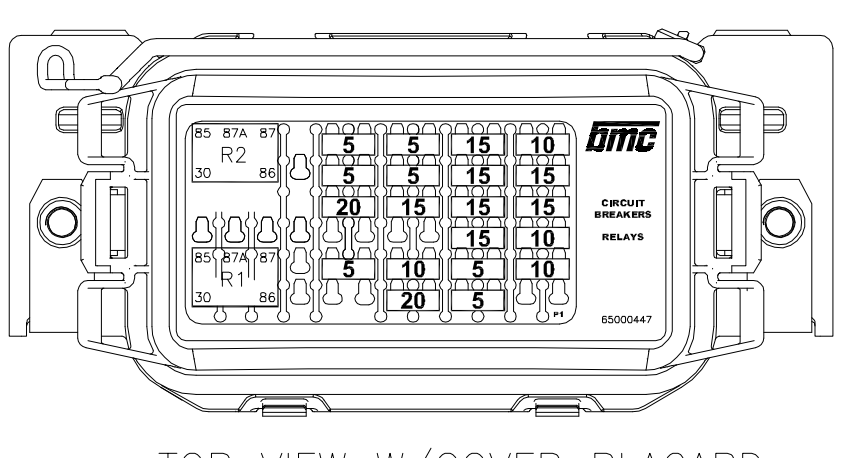

40000298