

PRINTED IN USA
P/N 990-30235

COPYRIGHT© 2017
BRODERSON MFG. CORP.
LENEXA, KANSAS 66215

**OPERATION AND
MAINTENANCE MANUAL
IC-100-3A
4x2 & 4x4**

OWNER: _____

SOLD AND SERVICED BY: _____

MODEL NO. _____ SERIAL NO. _____

BRODERSON MANUFACTURING CORP.

STATEMENT OF WARRANTY FOR MOBILE CRANES

Broderson Manufacturing Corp. ("BMC") warrants its products to be free from defects in material or workmanship at the date of shipment from BMC. This warranty shall be effective only when validated by the return to BMC of its standard form of Warranty Validation Certificate (Attachment A), duly completed and signed by the original purchaser from BMC and any subsequent purchaser who buys a BMC product as a new product, and then only as to defects reported to BMC in writing within 1 year or 2000 hours, whichever occurs first, from the date a product is placed in service, as evidenced by such warranty validation certificate. **THIS WARRANTY APPLIES TO ALL PARTS OF BMC'S PRODUCTS EXCEPT ENGINES, DRIVE TRAINS, HYDRAULIC SYSTEM COMPONENTS, TIRES, OR ACCESSORY EQUIPMENT, WITH RESPECT TO WHICH BMC MAKES NO WARRANTY OF MERCHANTABILITY OR FITNESS FOR A PARTICULAR PURPOSE AND NO OTHER WARRANTY OF ANY KIND, EXPRESS OR IMPLIED;** the sole warranties, if any, with respect thereto being those made by the respective manufacturers thereof.

THE SOLE REMEDY FOR BREACH BY BMC OF THIS WARRANTY SHALL BE THE REPLACEMENT OF ANY PARTS OF ITS PRODUCTS WHICH WERE DEFECTIVE AT THE DATE OF SHIPMENT OR, IF (AND ONLY IF) REPLACEMENT OF DEFECTIVE PARTS IS IMPOSSIBLE OR IS DEEMED BY BMC TO BE IMPRACTICAL, REPLACEMENT OF THE ENTIRE PRODUCT OR, AT BMC'S OPTION, REFUND OF THE PURCHASE PRICE. The replacement remedies include labor in connection with the removal of defective parts and the installation of their replacements, as well as the cost of delivery and transportation of defective products or parts and the replacements thereof. The sole purpose of these remedies is to provide the purchaser with free replacement of defective parts or, in the limited circumstances specified, replacement of the entire product or a refund of the purchase price. These exclusive remedies shall not be deemed to have failed of their essential purpose so long as BMC is willing and able to replace defective parts or the entire product or to refund the purchase price. The remedies herein provided shall be available only if BMC is given reasonable access to the product, including all allegedly defective parts, promptly after the defect is discovered. BMC shall have the right to return any allegedly defective parts to its plant or any other location selected by it, for inspection and testing to determine whether they were defective at the date of shipment, prior to replacement thereof.

The warranty herein made is extended only to the original purchaser from BMC and any subsequent purchaser who buys a BMC product as a new product. **WITHOUT LIMITING THE GENERALITY OF THE FOREGOING, BMC EXPRESSLY DISCLAIMS THAT THE WARRANTY MADE HEREIN EXTENDS TO A PERSON WHO RENTS OR LEASES ANY BMC PRODUCT OR WHO PURCHASES ANY BMC PRODUCT AS A USED PRODUCT.** For purposes hereof, a BMC product shall conclusively be deemed "used" after the expiration of twelve (12) months from its placement in service, as evidenced by a duly completed and signed warranty validation certificate actually received by Broderson, or after such earlier time as it has been operated for more than one hundred (100) hours. This warranty shall not apply to ordinary wear and tear; negligence; acts of God; vandalism; abuse; misuse; neglect; accident or causes beyond the reasonable control of BMC, including without limitation fires, freezing, floods and other natural disasters; overloading; unauthorized altered, modified or changed products or parts; products or parts that have been improperly adjusted; or the Purchaser's neglect, negligence or willful damage; any products or parts not provided by BMC; any products or parts which have been repaired outside of BMC or an authorized distributor facility ; unless authorized in writing by BMC; or damages caused by failure to follow the maintenance procedures outlined in the applicable service manual or in technical bulletins issued by BMC.

BMC does not warrant any of its products to meet any state, local or municipal law, ordinance, code, rule or regulation. The purchaser must assume the responsibility for maintaining and operating the products which are the subject of this warranty in compliance with such of the foregoing as may be applicable, and BMC shall not be liable for the purchaser's failure to meet such responsibility.

THE WARRANTY HEREIN MADE IS IN LIEU OF ANY OTHER WARRANTY, EXPRESS OR IMPLIED. BMC MAKES NO WARRANTY OF MERCHANTABILITY OR FITNESS FOR A PARTICULAR PURPOSE, OR ANY OTHER EXPRESS OR IMPLIED WARRANTY OF ANY KIND, TO ANY PURCHASER, LESSEE OR RENTER OF NEW OR USED BMC PRODUCTS OR ANY OTHER PERSON WHATSOEVER. NO PERSON IS AUTHORIZED TO ACT ON BEHALF OF BMC IN MODIFYING THE WARRANTY HEREIN MADE OR IN MAKING ANY ADDITIONAL OR OTHER WARRANTY.

IN NO EVENT SHALL BMC BE LIABLE FOR INCIDENTAL OR CONSEQUENTIAL DAMAGES OF ANY KIND WHATSOEVER. THIS EXCLUSION OF INCIDENTAL AND CONSEQUENTIAL DAMAGES IS INTENDED TO BE INDEPENDENT OF ALL OTHER PROVISIONS OF THIS STATEMENT OF WARRANTY AND SHALL BE GIVEN FULL EFFECT NOTWITHSTANDING THE UNENFORCEABILITY OR FAILURE OF THE ESSENTIAL PURPOSE OF ANY OTHER PROVISION OF THIS STATEMENT OF WARRANTY.

THE FOREGOING DISCLAIMERS OF WARRANTIES AND DISCLAIMER OF LIABILITY FOR INCIDENTAL OR CONSEQUENTIAL DAMAGES SHALL BE EFFECTIVE REGARDLESS OF WHETHER THE EXPRESS WARRANTY CONTAINED HEREIN BECOMES EFFECTIVE AS PROVIDED IN THE FIRST PARAGRAPH HEREOF.

TABLE OF CONTENTS

SECTION 1	DESCRIPTION and SPECIFICATIONS	
	Introduction.....	1-1
	IC-100-3A Dimensions.....	1-2
	Turning Dimensions.....	1-3
	Description and Specifications.....	1-4
SECTION 2	OPERATION	
	Safety Rules.....	2-1
	Instruments and Controls.....	2-8
	Control Functions.....	2-10
	Three-Mode Steer Operation.....	2-10
	Sequence of Operation.....	2-10
	Driving the Vehicle.....	2-10
	Operating the Crane.....	2-11
	Normal Gauge Readings.....	2-11
	Rated Capacity Limiter.....	2-12
	Crane Capacity.....	2-13
	Crane Capacity Chart IC-100-3A.....	2-15
	Capacity Example.....	2-16
	Sheave Block and Downhaul Weight.....	2-17
	Two-Part-Line Reeving.....	2-18
	Safety Devices.....	2-19
	Outrigger Check Valve.....	2-19
	Boom Elevation Cylinder Holding Valve.....	2-19
	Telescope Cylinder Holding Valve.....	2-19
	Anti-Two-Block System.....	2-19
	Optional Equipment Operation.....	2-20
	Installing and Stowing Boom Extension.....	2-21
	Capacity Examples for Boom Extension.....	2-22
	Front Auxiliary Winch.....	2-23
	Pintle Hooks.....	2-24
	Optional Four-Wheel Drive.....	2-24
	Switch and Indicator Symbols.....	2-25
SECTION 3	MAINTENANCE	
	Safety Rules.....	3-1
	New Unit Inspection and Testing Checklist.....	3-3
	Operator Inspection and Testing Checklist.....	3-4
	Maintenance Checklist.....	3-5
	Lubrication.....	3-7
	Swing Bearing.....	3-7
	Transmission Fluids.....	3-7
	Axle Lubrication.....	3-7
	Fluid Volume Chart.....	3-7
	Lubrication Chart.....	3-8
	Lubrication Schedule.....	3-9
	Hoist Cable.....	3-10

SECTION 3 MAINTENANCE (continued)

Hoist Cable Installation and Inspection.....	3-10
Hydraulic System Description.....	3-12
Steering System.....	3-12
JIC Schematic.....	3-13
JIC Schematic Metric.....	3-14
Hydraulic System Maintenance.....	3-15
Care of Hydraulic Oil.....	3-15
Hydraulic Oil Specifications.....	3-16
Hydraulic Seals.....	3-17
Hydraulic System Adjustments.....	3-18
Control Valves.....	3-18
Boom Elevation Cylinder Holding Valve.....	3-19
Telescope Cylinder Holding Valve.....	3-20
Engine Maintenance.....	3-20
Air Cleaner Service.....	3-20
Cooling System.....	3-21
Spare Parts List.....	3-21
Major Engine Servicing.....	3-21
Mechanical Adjustments.....	3-21
Fasteners.....	3-21
Swing Gearbox.....	3-21
Rear Wheel Bearings.....	3-21
Wheel Toe-In Setting.....	3-21
Transmission Troubleshooting & Overhaul.....	3-21
Park Brake Test and Adjustment.....	3-22
Maintenance Info for Optional Four Wheel Drive	3-22
Torque Data.....	3-23
Wiring Diagram.....	

BRODERSON MANUFACTURING CORPORATION

IC-100 INDUSTRIAL CRANE

INTRODUCTION

The Broderson IC-100 was designed and built to provide safe, dependable and efficient crane service. This we warrant by our testing and quality control procedures. To properly utilize the full potential of the equipment, the following customer controlled conditions must exist:

1. The operator must understand the equipment.
2. The operator must know the operating characteristics.
3. The operator must observe the safety rules.
4. The equipment must be given proper maintenance.

This manual was written to provide information required for these conditions. The recommendations for periodic inspection, test and maintenance are minimum standards for safe and economical performance.

When ordering parts, the unit serial number, unit model number, part number, part description and quantity must be provided.

This unit must not be altered or modified without written factory approval.

To reorder this manual, ask for IC-100-A Operation and Maintenance Manual, Part Number-990-30235. Contact your Broderson Service Representative at:

Broderson Manufacturing Corp.
14741 W 106th St
Lenexa, Kansas 66285 USA
913-888-0606

NOTICE

If this crane becomes involved in an accident, please call Broderson Manufacturing Corp at 913-888-0606, and ask for the Legal Department or the Service Manager. Also, please notify your Broderson dealer.

IC-100-3A DIMENSIONS

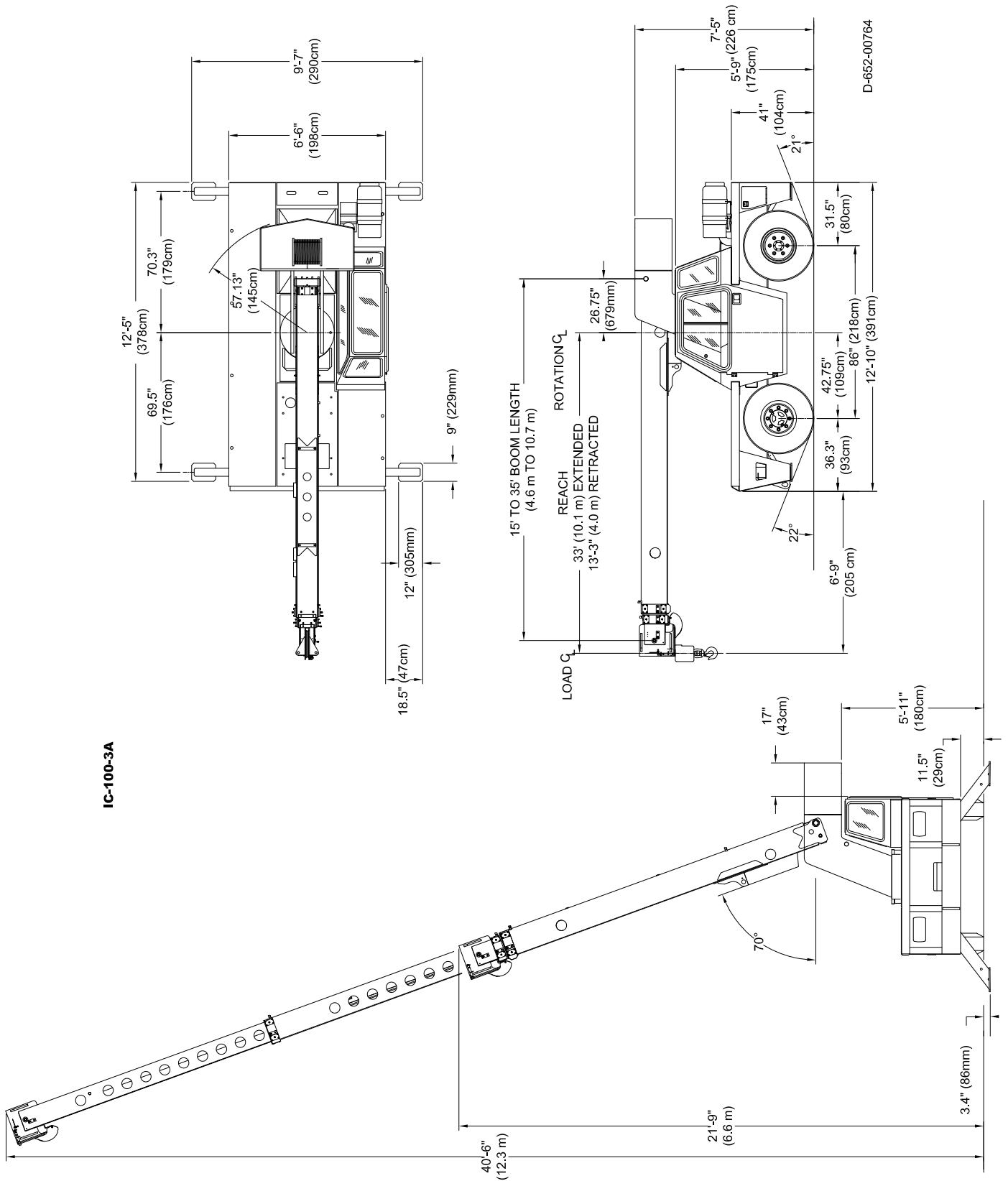

IC-100-A TURNING DIMENSIONS

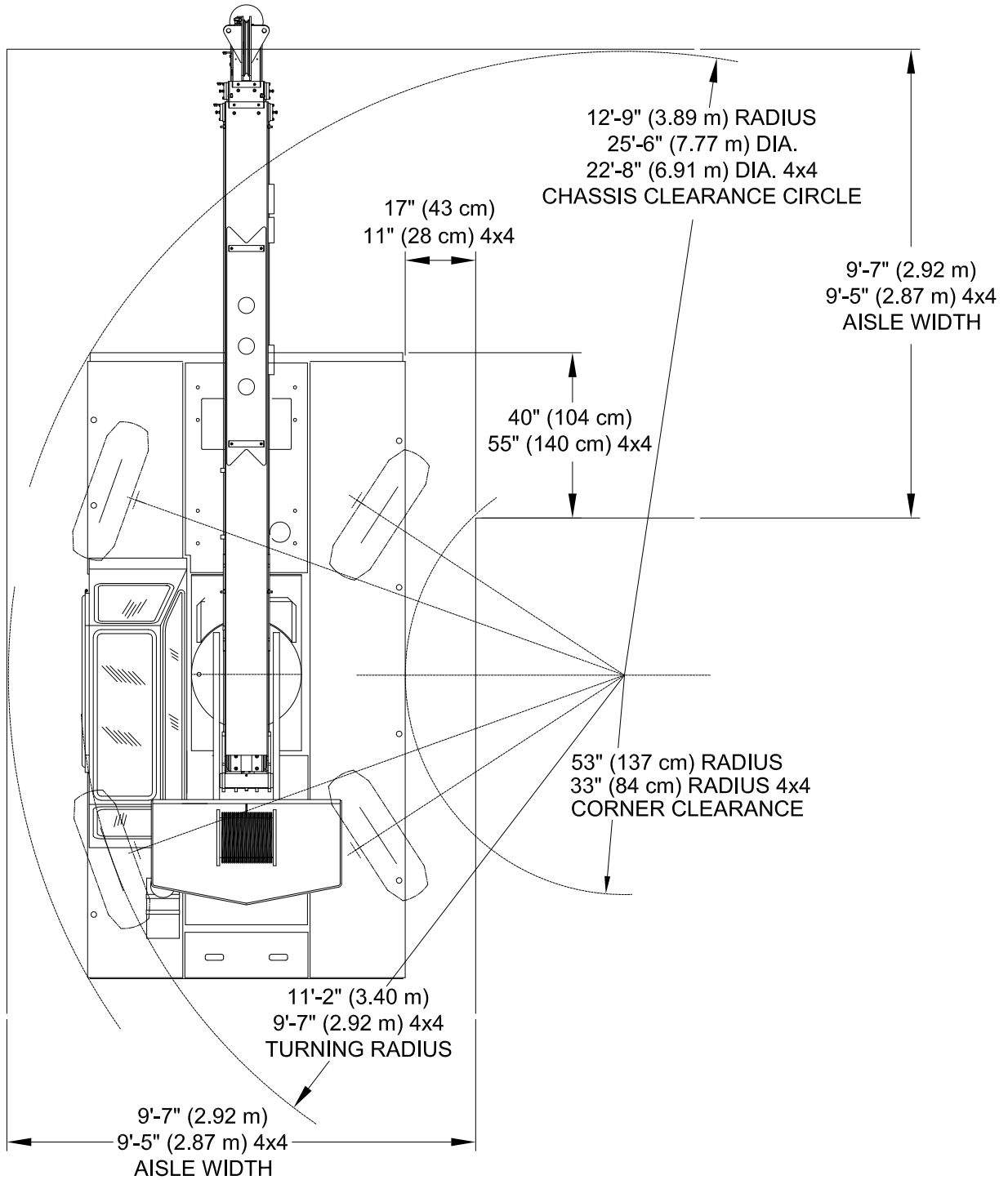

FOUR-WHEEL STEER IC-100-3A

65200765

DESCRIPTION AND SPECIFICATIONS

The IC-100-A is a self-propelled Industrial Crane designed for in-plant lifting and material handling applications, with special features of low height, narrow width, short length, cargo deck, and standard four-wheel steer and front-wheel drive. The chassis includes a frame, four independently controlled hydraulic outriggers, engine, torque converter, 4-speed powershift transmission, front planetary drive/steer and rear steer axles, fuel tank, hydraulic tank, control station, and full power steering. The boom assembly includes a hydraulic powered continuous rotation turret, 3-section boom, hydraulic boom elevating cylinder, hydraulic boom telescoping cylinders, and hydraulic powered hoist. Rated Capacity Limiter is standard.

IC-100-3A:

3-section hydraulically extended boom with capacity of 20,000 pounds (9000 kg) at a 5-foot load (1.5 m) radius.

General:

Length:	
IC-100-3A	19.6 feet (5.97 m)
Width	78 inches (1.98 m)
Height:	
Overall	7.4 feet (2.26 m)
Deck	41 inches (1.04 m)
Wheelbase	86 inches (2.18 m)
Ground Clearance:	
Chassis	11.5 inches (292 mm)
Minimum (muffler)	5.75 inches (146 mm)
Angle of Approach	22 degrees
Angle of Departure	21 degrees
Outriggers:	
Spread	9.6 feet (2.92 m)
Penetration	3.4 inches (86 mm)

General Continued:

Boom Movement:		
Rotation		Continuous
Elevation		0° to 70°
Telescope		20 feet Hyd. (6.10 m)
Boom Speeds:		
Rotation		2 RPM
Elevation		12 seconds
Telescope		30 seconds
Sheave Height: (Nominal)		
W/O Boom Extension		39.7 feet (12.1 m)
With Boom Extension		49.3 feet (15.0 m)
Horizontal Reach:		
W/O Boom Extension		33.0 feet (10.1 m)
With Boom Extension		43.0 feet (13.1 m)
Weight: (Nominal)		
2-Wheel Drive		17,520 pounds
(w/ GM 3.0L Engine)		(7950 kg)
Front Axle		8910 pounds
		(4040 kg)
Rear Axle		8610 pounds
		(3910 kg)
4-Wheel Drive		18,370 lbs
(w/ Cummins 3.3L Engine)		(8330 kg)
Front Axle		9010 lbs
		(4090 kg)
Rear Axle		9360 lbs
		(4240 kg)
Steering:		
Turning Radius		11.17 feet (3.40 m) (4-Wheel Steer)
Aisle Width for 90° Turn		9.6 feet (2.92 m)
Steering Modes		Rear Steer, Round Steer, Crab Steer

	<u>4X2 GAS</u>	<u>4X2 DIESEL</u>	<u>4X4 DIESEL</u>
Road Speed	19 mph (31 km/h)	22 mph (35 km/h)	17 mph (27 km/h)
Drawbar Pull	9500 lbs (4300 kg)	10500 lbs (4800 kg)	13500 lbs (6100 kg)
Gradeability	57% (30°)	63% (32°)	79% (38°)
	(Calculated values, wheels may spin before these values are reached.)		
Grade Limit	15% (8.5°)	15% (8.5°)	15% (8.5°)

Engine:**Standard Gasoline:****GM 3.0L EPA Tier II w/ Dual Fuel:**

GM Model 3.0L industrial gasoline engine with multi-port electronic fuel injection, dual fuel, catalytic converter, and engine management system. Water cooled, 4-cylinder, 181 CID (3.0 L), bore 4.00 inches (102 mm), stroke 3.60 inches (91 mm), 59 HP (44 kW) at governed speed of 2500 RPM. Maximum torque, 138 foot-pounds (187 Nm) at 1600 RPM. Also includes special exhaust valves, seats and valve rotators for use with LPG, 70-amp alternator, 17.6-gallon (66.6 L) fuel tank and 33-pounds (15 kg) LPG tank. High temperature and low oil pressure shutdown is included in engine management system. Throttle control switch for setting engine speed at 1200 or 1800 RPM.

Optional Engines and Engine Accessories:**Diesel Engine:****Cummins B 3.3L Turbo, EPA Tier IV Interim:**

Cummins B 3.3 turbo-charged diesel industrial engine. Water cooled, 4-cylinder, 199 CID (3.3 L), bore 3.74 inches (95 mm), stroke 4.53 inches (115mm), 74 HP (55kW) at governed speed of 2600 RPM. Maximum torque, 274 pounds-foot (371 Nm) at 1600 RPM. 90-amp alternator included. 17.6-gallon (66.6 L) fuel tank. Net Weight: 180 pounds (82 kg)

Spark Arrester Muffler:

Spark arrester muffler used in addition to standard muffler.
Net Weight: 10 pounds (5 kg)

Catalytic Converter:

Catalytic converter for diesel engine. Reduces emissions.
Net weight: 10 pounds (5 kg)

Engine Heater:

Engine coolant heater installed with hoses in coolant system to circulate warm water through engine. Plugs into 120-volt AC extension cord. 1500 watts.

Transmission:

Powershift transmission with 4 speeds in forward and reverse. Provides powershifts at any engine speed in any gear. All shifting is done with a single lever electrical control mounted on the steering column. Multiple-disc clutch packs operated by solenoid valves provide forward, neutral, reverse and speed selection. Equipped with oil cooler and filter.

Torque Converter:

Stall torque ratio of 2.2/1. Attached to engine flywheel.

Gear	Ratios	<u>4X2 GAS</u>		<u>4X2 DIESEL</u>		<u>4X4 DIESEL</u>	
		Travel Speed MPH (km/h)	Drawbar Pull LBS (kg)	Travel Speed MPH (km/h)	Drawbar Pull LBS (kg)	Travel Speed MPH (km/h)	Drawbar Pull LBS (kg)
1st	5.72/1	4 (6)	9500 (4300)	4 (6)	10500 (4800)	3 (5)	13500 (6100)
2nd	3.23/1	7 (11)	5500 (2500)	7 (11)	6000 (2700)	6 (10)	9000 (4100)
3 rd	1.77/1	12 (19)	3000 (1300)	13 (21)	3500 (1600)	10 (16)	5000 (2300)
4th	1.00/1	19 (31)	1800 (800)	21 (34)	2000 (900)	17 (27)	2800 (1300)

(Calculated values; wheels may spin before these values are reached.)

Front Axle:

Standard:

Planetary drive axle with 11.625/1 ratio. Differential is "No Spin." Front axle is mounted rigidly to frame.

Optional 4-Wheel drive:

Planetary drive/steer axle with integral drop box input for an overall 13.76/1 ratio. Differential is "No Spin." Oscillation is 1½ degrees in either direction. Only available with mining and industrial tires. Net Weight: 600 pounds (270 kg)

Rear Axle:

Standard:

Drop-center axle beam casting with 1½ degree oscillation in either direction.

Optional 4-Wheel drive:

Planetary drive/steer axle with overall 13.76/1 ratio including the reduction through the front-axle-mounted drop box. Differential is limited slip. Oscillation is 1½ degrees in either direction. Only available with mining and industrial tires. Diesel engine is required for this option. Net Weight: 935 pounds (425 kg) including front axle.

Steering:

Standard:

Hydraulic steering unit with one double-rod cylinder on rear axle and one double-rod cylinder on front axle. Allows limited steering when engine is not running. Rear axle is the primary steer. An electric switch in the operator's compartment is used to select rear-wheel steering, four-wheel round steering or crab steering. Electronic sensors and control box automatically align the steering when a new mode is selected.

Brakes:

Standard:

Four-wheel hydraulic. Wet disc brakes are on the front and rear axles. Parking brake is disc type.

Brakes on Optional 4-Wheel Drive:

Wet disc on both axles. Parking brake is disc type.

Tires:**Standard:**

10.00 x 15, 16-ply, highway type tread.

Mining and Industrial Tires:

36 x11-15, 16-ply rating pneumatic tires. Net Weight: 120 pounds (57 kg)

Mining and Industrial Tires, Non-Marking for 4x2:

10.00 x 15, 16-ply rating pneumatic tires. Net Weight: 120 pounds (57 kg)

Tire Options:**Solid Rubber Tires:**

8.25 x 15. These tires will reduce overall height and ground clearance by 1½ inches. Net Weight: 400 pounds (181 kg)

Foam Filling of Tires:

10.00 x 15, All four tires foam filled.
Net Weight: 900 pounds (408 kg)

Spare Tire and Wheel Mounted:**Highway Tread, 10.00 x 15, 16-ply, Radial:**

Net weight: 163 pounds (74 kg)

Mining and Industrial Tire:

Net weight: 193 pounds (88 kg)

Mining and Industrial Tire, Non-Marking:

Net weight: 193 pounds (88 kg)

Chassis:**Standard:****Cargo Deck:**

Total Deck Area: 53 square feet (5 m²). A maximum of 14,000 pounds (6350 kg) may be carried on the deck when centered over or between axles. Seven stake pockets are provided along edges of deck for 1.3-inch (34 mm) pipe stakes. Stakes furnished. Cargo decks have skid resistant coating. Heavy deck loads allowed at creep speed, below 2 MPH (3.2 km/h) and less than 200 feet (61 m) in 30 minutes.)

Fire Extinguisher:

1-A:10-BC, 2½ pound (1.1kg) dry chemical. Mounted in operator's compartment.

Lifting Rings:

Consists of four rings, one at each corner of the load deck, so sling can be attached for lifting crane. Rings hang below deck surface when not in use.

Tie Downs:

Two holes in the rear bumper (in conjunction with the pulling eyes) provide tie down location for transporting crane by truck or cargo container.

Steps:

A step is located on each front corner providing access to deck area.

Battery:

Located behind door on left hand rear corner of chassis. Compartment available on right hand rear corner of chassis for second battery if necessary.

Outriggers:

Four hydraulic outriggers of box-beam construction. Independent controls for each outrigger. Hydraulic cylinders are equipped with direct-connected holding valves. Pad dimensions: 9 inches (23 cm) x 12 inches (30 cm)

Pulling Eyes:

Heavy eyes on front bumper provided for attachment of hook block so main hoist line can be used for pulling loads at or near floor level.

Vandalism Protection:

Lockable hood for protection of engine compartment.

Accessory Storage Box:

Consists of box under front deck plate for carrying sheave block and other items. Flush fitting cover is lockable. Storage box is 14 inches deep (35 cm) x 10½ inches wide (26 cm) x 27 inches (68 cm) long.

Headlight and Taillight Grilles:

Consists of welded steel protective grilles for headlights and taillights. Easily removable for replacing bulbs.

Chassis Options and Accessories:**Auxiliary Winch:**

Optional worm gear winch, mounted behind front bumper, with a lever control at the operator's console. Hydraulic powered to provide bare drum line pull of 5000 pounds (2260 kg) at 46 feet per minute (14 m/min). Winch drum is 3½ inches (90 mm) diameter by 11 inches (279 mm) long. This winch includes 75 feet (23 m) of 3/8-inch (9.5 mm) wire rope, hook and four-way roller guide. Net Weight: 100 pounds (45 kg)

Pintle Hook - Rear:

T-60-A Holland pintle hook mounted on rear frame member provides capacity for 2000 lbs (900 kg) tongue weight and 10,000 lbs (4530 kg) trailer weight. Net Weight: 10 pounds (5 kg)

Pintle Hook - Front:

T-60-A Holland pintle hook mounted on front frame member. Provides same capacity as rear pintle hook. Net Weight: 25 pounds (11 kg)

Rearview Mirrors:

One right-hand and one left-hand mirror, 6 inches (152 mm) wide x 16 inches (406 mm) high, mounted on deck stakes. Pivot out of way when contacted by obstacle at side of deck. Net Weight: 12 pounds (5 kg)

Operator's Compartment:**Standard:**

Operator's control station provides one-position access to all operating functions. Includes adjustable operator's seat and retracting seat belt, fire extinguisher and bubble level.

Drum Rotation Indicator:

Provides visible feedback to operator when hoist drum is rotating. Light on dash flashes when drum is turning. Feedback is proportional to hoist speed.

Operator's Compartment Options and Accessories:**Operator's Guard:** (Not Available with Cab)

Tubular steel weldment with heavy expanded steel mesh top section, bolts over the operator's compartment. Net Weight: 55 pounds (25 kg)

Operator's Guard Door:

Hinged door covers operator compartment side opening. Has latch handle outside and knob inside. Rubber gasket contacts chassis.
Net Weight: 40 pounds (18 kg)

All Weather Cab:

Consists of rigid mounted canopy section and removable hinged door with safety glass. Rugged canopy structure with laminated glass front and top. Top glass is 3/8 inch thick. Door is equipped with a keyed lock to protect operator's station. Includes defroster fan, 24,000 BTU heater with two-speed fan and 12V electric windshield wiper. There are sliding windows in the door and right-hand side. Dome light is included for operator's convenience. Net Weight: 215 pounds (98 kg)

Cab Heater Only:

Provides 24,000 BTU heater with two-speed fan for units without All Weather Cab. Net Weight: 12 pounds (5 kg)

Windshield Washer:

Provides reservoir, pump and nozzle for windshield washer.

Floor Mat:

Vinyl mat with foam backing covers floor, front wall and lower portion of right hand wall of operator's compartment.

Deluxe Seat:

Deluxe Seat with upholstery springs provides additional operator comfort.
Net Weight: 15 pounds (7 kg)

Noise Reduction Kit - Cab:

Includes rubber floor mats and control valve cover and side panels of foam-backed perforated vinyl for noise reduction. Net Weight: 13 pounds (6 kg)

Air Conditioning:

Complete system using 134a coolant. Has combination cooling and heating unit in cab. Net Weight: 125 pounds (57 kg)

Electrical System:

Standard:

12-Volt Battery:

Gas Units: Group 27 with 540 CCA rating.

Diesel Units: Group 31 with 950 CCA rating.

Instrument Group:

Located at operator's station and includes fuel gauge, hourmeter and bubble level. Hourmeter records hours only during actual engine operation. Also included are: warning lights for low oil and transmission pressure, turn signal, high beams, hazard lights, parking brake, hydraulic oil temperature, battery, check engine, stop engine, coolant temperature, engine oil pressure, transmission temperature, and outriggers.

Lighting Group:

Consists of two 12V lamps, with high and low beams for driving; integral tail, brake and turn signal lights and backup lights in rear; front turn signals and emergency flasher switch at operator's station. 12V horn actuated by button located on shifting control.

Back-Up Alarm:

Provides pulsating sound from a 102 dB alarm when ignition is on and transmission is in reverse. Conforms to SAE J994b.

Outrigger Alarm System:

102 dB alarm with alternating two-tone sound is actuated by a switch when the OUTRIGGER DOWN controls are operated.

Optional Electrical Accessories:

Strobe Lights:

Two yellow strobe lights, one on each side of turret weight box, for high visibility all around crane. Flash 60-120 times per minute. Each strobe draws only one-half amp. Includes operator controlled switch.

Boom Work Lights:

Two work lights, one on left side of boom to light boom tip, and one on right side of the turret to light ground under boom tip. Includes switch at operator's station. Net Weight: 10 pounds (5 kg)

Work Lights Rear:

Two work lights recessed into rear bumper. Provides lighted work area to rear of machine.

Hydraulic System:**Standard:**

Tandem pump, direct-driven by engine crankshaft, delivers 16 GPM (61 L/min) at 3000 PSI (207 bar) and 32 GPM (121 L/min) at 3000 PSI (207 bar) at 2500 RPM governed engine speed. System protected by relief valves, suction line strainer and 10-micron full-flow return line filter. 25-gallon (95 L) reservoir equipped with filler cap and breather element.

Boom Assembly:**Standard:**

Three-section, high strength steel construction, equipped with bearing pads for efficient support and extension. Double-acting hydraulic cylinders extend boom sections. Telescope cylinder and the boom elevation cylinder are equipped with direct-connected holding valves. Boom angle indicator on side of boom.

Boom Rotation:**Standard:**

Heavy-duty bearing rotation gear with external teeth supports boom. Rotation is powered by hydraulic motor and worm gear drive. Rotation gearbox may be adjusted as wear occurs to minimize backlash. Boom is attached by high strength steel weldment.

Main Hoist:**Standard:**

Turret-mounted, planetary gear hoist, is hydraulically powered to provide a bare-drum line pull of 11,300 lbs (5200 kg) at a speed of 100 feet per minute (30.5 m/min). Hoist drum 11.65 inch (296 mm) diameter by 12.89 inches (327 mm) long. Provides even pull and long cable life.

Main Hoist Rope:**Standard:**

Main hoist rope is 9/16" (14 mm) diameter, Warrington-Seale construction, 6x36 classification, EIP grade, IWRC core, RRL lay, minimum breaking strength 35,000 lbs (156 kN), 140' (43 m) long. Weight per foot is 0.6 lbs (0.9 kg per m). Note that rope weight is not included in load calculations.

Boom Attachments:**Standard:****Anti-Two-Block Device:**

Prevents damage to hoist rope and/or machine components from accidentally pulling sheave block or downhaul weight against boom tip. Consists of trip arm at boom tip, which is moved upward by sheave block or downhaul weight as hook approaches boom tip. Trip arm actuates electric switch, which is connected through cable reel mounted on boom to solenoid dump valve in the hydraulic circuit. This valve will dump the HOIST RAISE, TELESCOPE EXTEND, BOOM LOWER, SWING LEFT and SWING RIGHT circuits. No other circuits are affected. These circuits are returned to normal operation by operating the HOIST LOWER or TELESCOPE RETRACT control.

Rated Capacity Limiter:

Operator's aid that warns operator of impending overload with audible and visual signals. Has read-outs for load, boom angle, boom length and load radius. In the event of an overload, dumps the following boom functions: HOIST RAISE, TELESCOPE EXTEND, BOOM LOWER, SWING LEFT and SWING RIGHT. These circuits are returned to normal by lowering load to a safe resting place with hoist or by retracting or raising boom to a shorter load radius. There is also an override switch under the dashboard.

Sheave Block and Downhaul Weight:

A 124-pound (56 kg) sheave block is provided for two-part line requirements. Block is shorter than normal, 21½ inches (546 mm) from top to saddle of load hook. 10 inch (254 mm) O.D. sheave for 9/16 inch (14 mm) rope. Has swivel hook with safety latch. A 90-pound (41 kg) downhaul weight and swivel hook are also provided for single-part line.

Optional Boom Attachments:**Boom Extension - 10 Ft (3 m):**

Provides 10 feet (3 m) of additional length for lifting loads with load line. Boom extension may be stowed alongside base boom section when not in use. Tip sheave, attaching brackets and pins included. Deduct 100 pounds (45 kg) from Capacity Chart when boom extension is in the stowed position. Includes switch for Anti-Two-Block. Net Weight: 300 pounds (136 kg)

Boom Extension - 10 Ft (3m) Offset:

Has three settings: 0° (in-line), 15° offset and 30° offset. Net Weight: 350 pounds (159 kg)

Searcher Hook - Nose Mount:

5000 pound (2268 kg) capacity. Swivel hook with spring latch hangs from support structure projecting outward from boom tip. Net Weight: 41 pounds (19 kg)

Specifications subject to change without notice.

OPERATION SECTION

SAFETY RULES

GENERAL:

1. Since the manufacturer has no direct control over machine application and operation, conformance with good safety practice is the responsibility of the user and his operating personnel.

2.

	⚠ WARNING
	UNSAFE OPERATION DO NOT OPERATE THIS MACHINE UNLESS YOU ARE QUALIFIED BY TRAINING AND EXPERIENCE. DEATH OR SERIOUS INJURY CAN RESULT FROM AN UNTRAINED OPERATOR.
TRAINING INCLUDES COMPLETE KNOWLEDGE OF YOUR EMPLOYER'S WORK RULES, ALL GOVERNMENTAL REGULATIONS, AND MANUFACTURE'S OPERATION AND SAFETY MANUALS FOR THIS MACHINE. A-652-00604	

3.

	⚠ WARNING
	FALLING HAZARD DO NOT INSTALL PERSONNEL PLATFORMS TO BOOM TIP OR LOAD LINE. THIS PRODUCT IS NOT INTENDED TO LIFT PERSONNEL. DEATH OR SERIOUS INJURY CAN RESULT. A-652-00612

4. The operator shall be responsible for those operations under his direct control. Whenever there is any doubt as to safety, the operator shall have the authority to stop and refuse to handle loads until safety has been assured.
5. The operator shall not engage in any practice which will divert his attention while actually operating the crane.
6. Do not run the engine in an enclosed area or indoors without adequate ventilation.
7. Do not use ether for starting. Ether is highly flammable and can be ignited by the intake manifold heater grid, causing engine damage or operator injury.
8. This list of rules is only a supplement to all federal, state, and local safety rules that may apply.

CRANE CONDITION:

1. Before beginning operation each day, thoroughly inspect the entire crane to be sure it is in good operating condition.
2. Inspect load hoist rope and wedge socket daily. We recommend rope inspection, replacement and maintenance in accordance with ASME B30.5, Sec. 5-2.4.

	⚠ WARNING
	FALLING OBJECTS WIRE ROPE WILL FAIL IF WORN-OUT, OVERLOADED, MISUSED, DAMAGED, IMPROPERLY MAINTAINED OR ABUSED. WIRE ROPE FAILURE MAY CAUSE SERIOUS INJURY OR DEATH! SEE ASME B30.5, SEC 5-2.4 FOR PROPER INSPECTION AND MAINTENANCE. B-652-00614

3. Keep operator's compartment and decks free of mud and grease.
4. If crane is equipped with a cab, keep all window glass clean. Keep gauges clean.
5. Tools, lubricants, or rags on the crane should be kept in a secured toolbox.
6. Do not use ether for starting. Ether is highly flammable and can be ignited by the intake manifold heater grid, causing engine damage or operator injury.

7.

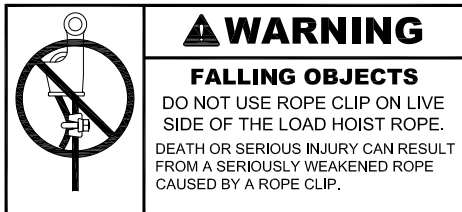

8.

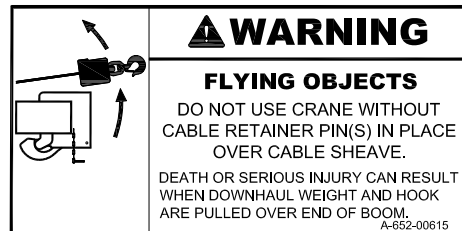

9. The Rated Capacity Limiter must be checked before each shift and after each setup for the proper operating configuration on the display. It must be inspected before each shift and tested with a known load at least once a month, as described in the RCL operation manual.

LIFTING:

1. Always refer to Crane Capacity Chart in operator's compartment before handling load. Do not exceed load ratings. Under some conditions the standard capacity ratings cannot be recommended and must be adjusted downward to compensate for special hazards, such as weak supporting ground, wind, hazardous surroundings, operator inexperience, etc. The weight of the load should always be known.

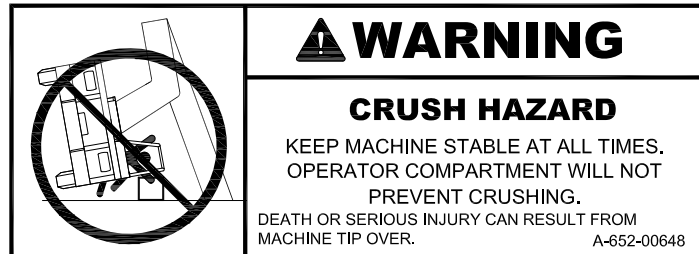

2. Be careful to prevent load swinging. A swinging load can cause instability or loss of control of the load. Be aware that the Anti-Two-Block System and the Rated Capacity Limiter can cause sudden stopping of boom movement, which can cause the load to swing. Swing the boom slowly whenever these systems might stop the boom.

3. Do not allow anyone to put any part of his body under a load. The load may lower or fall if there are damaged parts in the crane. Also, the load may drop a short distance due to thermal contraction of the hydraulic oil in the cylinders.

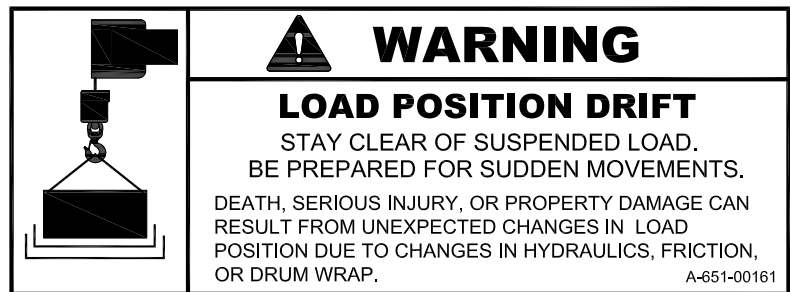

4. Do not use crane to drag loads sideways.

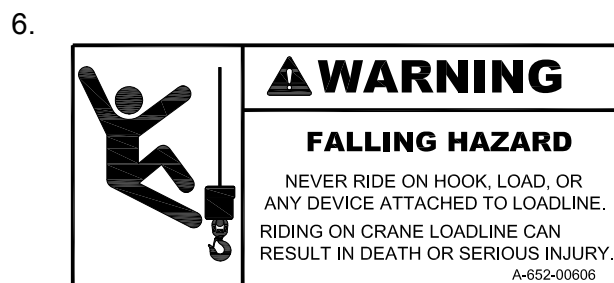

7. Level the crane before lifting. A small incline will significantly reduce the capacity. Use appropriate cribbing under the outriggers for leveling. All outriggers must be fully extended and tires must clear the ground to use the ON OUTRIGGERS ratings.

8. Always use outriggers if possible. If you must lift on rubber, keep the load as close to the ground as possible to prevent tipover. Move the load very slowly and use tag lines to prevent load swinging.

9. Crane may tip at less than rated loads if the surface is uncompacted or wet dirt, or soft soil with frozen crust, thin or cracked pavement, or surface near a hole or ledge. Always use adequate outrigger floats and/or cribbing. See page 2-14.

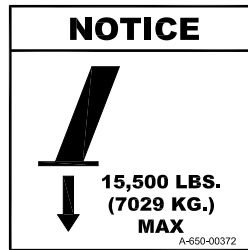

10. The operator shall not leave the controls while the load is suspended.
11. Always use adequate parts of load hoist line for lifting heavy loads.
12. Always be sure the rope is properly seated and wound evenly on hoist drum.
13. Keep hands away from load hoist rope when hoist is being operated.
14. Be sure at least three wraps of rope are left on the hoist drum to ensure against rope pulling out of its anchor.
15. Never wrap the hoist rope around a load. Always use approved rigging.
16. Avoid pinch points such as between a rotating turret and the cab, or in access holes of a telescoping boom, or between the two-block mechanism.

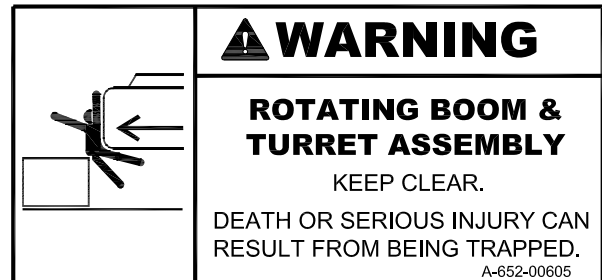

CAUTION

Keep hands out of Anti-Two-Block mechanism. Serious injury can result from moving parts.

- 17. Avoid two-blocking.
 - A. Stop raising hoist line before downhaul or hook block strikes boom tip plates.
 - B. Pay out hoist line while extending boom.
 - C. Maintain clearance between downhaul weight or hook block and boom tip while booming down.

DANGER

Two-blocking will abruptly stop boom lowering and boom swing, as well as hoist and extend. If the boom is moving fast, this will cause the load to bounce or swing, which could cause loss of control of load or tipping.

- 18. The amount of counterweight supplied with this crane should never be changed. Unauthorized addition of counterweight in the field to increase lifting ability constitutes a safety hazard.
- 19. Always keep crane boom at least 10 feet away from electric power lines. (See chart on side of turntable for boom clearance).

REQUIRED CLEARANCE FOR NORMAL VOLTAGE IN OPERATION NEAR HIGH VOLTAGE POWER LINES AND OPERATION IN TRANSIT WITH NO LOAD AND BOOM OR MAST LOWERED		
Normal Voltage, kV (Phase to Phase)	Minimum Required Clearance	
	ft	(m)
Operation Near High Voltage Power Lines		
to 50	10	(3.05)
Over 50 to 200	15	(4.60)
Over 200 to 350	20	(6.10)
Over 350 to 500	25	(7.62)
Over 500 to 750	35	(10.67)
Over 750 to 1000	45	(13.72)
Operation in Transit With No Load and Boom or Mast Lowered		
to 0.75	4	(1.22)
Over 0.75 to 50	6	(1.83)
Over 50 to 345	10	(3.05)
Over 345 to 750	16	(4.87)
Over 750 to 1000	20	(6.10)

REF. ASME/ANSI B30.5 - 1989 B-651-00097

- 20. If boom should accidentally contact a power line, keep ground personnel away from crane. Stay in the crane until the power source is de-energized. Move the crane away from electrical hazard if this does not cause new hazards. If it is absolutely necessary to leave the crane, **jump** clear of the crane with both feet together. Hop away from the crane with feet together. The ground surface may be energized.
- 21. Do not operate outside during thunderstorms. Avoid all lightning strike opportunities.

22. Crane has four lifting rings, one at each corner of load deck, for lifting the crane. Use proper slings and rigging methods to keep the load balanced during the lift. Do not lift by the boom. Proper lifting and securing practices are the responsibility of the rigger in charge.

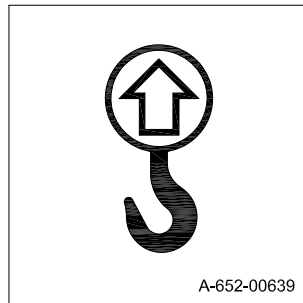

23. When transporting the crane, be sure it is properly secured to the vehicle. Utilize the tie-down anchors as indicated on the crane to stabilize the load and prevent shifting during transport. Use caution to not over-tighten the chains and binders when securing the crane to the transport vehicle. Proper securement and prudent shipping practices are the responsibility of the carrier.

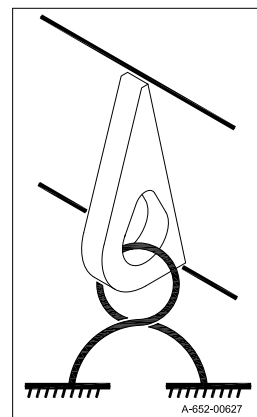
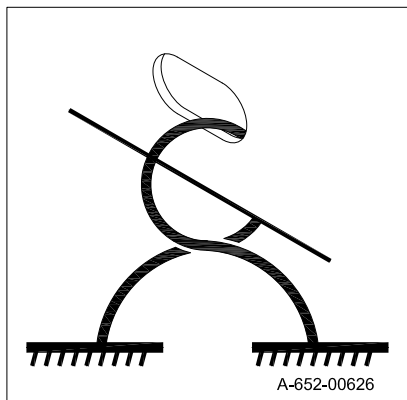

TRAVEL:

1. For Pick and Carry operation: Traveling with suspended loads involves so many variables, such as ground conditions, boom length and vehicle acceleration, that it is impossible to devise a single standard rating procedure with any assurance of safety. For such operations, the user must evaluate prevailing conditions and determine safe practices using precautions, such as the following:
 - A. The boom shall be centered over front axle.
 - B. Use shortest boom practical.
 - C. Carry load as close to ground as practical.
 - D. Reduce travel speed to suit conditions (2 MPH (3 km/h) maximum).
 - E. Maintain specified tire pressures.
 - F. Avoid sudden starts and stops.
 - G. Provide tag or restraint lines to snub swinging of the load.
 - H. Hand-held tag lines should be nonconductive.
 - I. Do not carry heavy boom loads and deck loads at the same time.
 - J. Do not pick and carry with boom extension installed.
 - K. Do not exceed the OVER FRONT, ON RUBBER capacity.
2. When raising the boom or moving the unit with boom elevated, be sure there is adequate overhead clearance for boom.
3. For carrying loads on decks:
 - A. Boom must be retracted, centered and lowered as close as possible.
 - B. 2 MPH (3km/h) maximum road speed. Reduce speed below 2 MPH (3km/h) to properly match condition of road surface and deck load stability.
 - C. Remove load hook from load before traveling.
4. Cranes with rear steering require close watch because of "tail swing" when the chassis is turned in tight quarters.

5.



6. Every effort has been made to make the BMC Industrial Crane a stable vehicle. However, with the rigid front axle and the unsprung oscillating rear axle suspension, the operator must take care to control the vehicle speed to be compatible with conditions of rough roads or uneven terrain.
7. When this crane is to be parked on a grade, set parking brake and block wheels or extend outriggers fully.

8. Shut off engine before refueling, and remove fuel cap slowly. Vapor pressure in tank can cause a burst of fuel and vapor when the cap is removed. Always refuel with proper fuel and into proper tank.
9. Know your visibility limitations. Loads being carried on the deck or hanging on the hook can add further limitations to visibility during travel. Always use a signal person when in doubt.

INSTRUMENTS AND CONTROLS

The IC-100 instrument panel is equipped with a fuel gauge, an hourmeter, and a bubble level. Also included are warning lights for low oil and transmission pressure, check engine, high coolant and transmission temperature, turn signal, high beam, hazard lights, and parking brake.

The ignition switch is key-operated and has OFF, RUN and START positions. The ignition switch should always be turned off and the key removed when the vehicle is left unattended. A horn button is on the shifting control.

The IC-100 is equipped with a standard lighting package. An on-off switch and a high beam indicator are on the instrument panel. The dimmer switch is located on the left-hand steering column control. Stop lights are controlled by operating the foot brakes. The turn signal control is located on the left side of the steering column. Move the lever down for a left turn; up for a right turn. The emergency flasher lights are actuated by a switch on the instrument panel.

The hand brake lever is located on the right side of the operator's seat. To apply, lift the lever until the over-center position is reached. When adjustment is required, turn the knurled knob on the end of the lever clockwise to tighten. The brake must be released before adjustment can be made. A warning light shows when the hand brake is applied. The brake and accelerator pedals are located and operated as they are in other vehicles already familiar to the operator.

A lever on the steering column controls the powershift transmission. Moving the lever upward engages the transmission clutch for forward travel. Rotating the handle of the lever selects the gear that is desired (first through fourth) and engages the clutch for that gear. To put the transmission in reverse, the machine should be brought to a stop. The lever then is pulled downward, through the neutral position, into reverse. The transmission and drive train components can be damaged by shifting from forward to reverse or vice versa while the unit is in motion, or while the engine speed is above 1000 RPM. A neutral safety switch prevents starting the engine with the transmission engaged. The shift lever must be in neutral to start the engine.

Normal engine speed control uses the foot accelerator pedal. On gas engines only a three position switch on the right dash panel provides preset engine speeds. Parking brake must be set to activate system. Press the high idle control switch temporarily to the right, the engine will lock into the preset levels. The center position of the switch enables the engine to dwell at 1,800 RPM. The left switch position will lower the engine speed to 1,200 RPM. To restore the foot accelerator, either temporarily release the parking brake fully or turn the engine off.

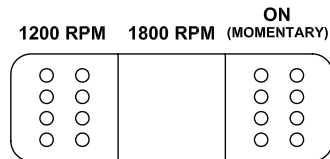

HIGH IDLE CONTROL ROCKER SWITCH

Three-mode steering is standard. Rear steer, 4-wheel round steer and crab steer can be selected with a switch on the dashboard. The steering wheel is directly mounted to the steering control unit of the all-hydraulic power steering system. The steering system will provide limited steering even if the engine should stop running.

The Rated Capacity Limiter display and input panel are mounted on the dashboard. Instructions are in the RCL Operation Manual and additional information is in the Operating the Crane section, the Crane Capacity section and Maintenance Section of this manual.

CONTROL VALVE FUNCTIONS

The controls for operating the outriggers, boom rotation, boom elevation, boom extension and hoist are located along the forward dashboard area. The control handles are directly connected to the 3-position hydraulic valves. The placard located next to these handles identifies the function and direction resulting from each handle movement.

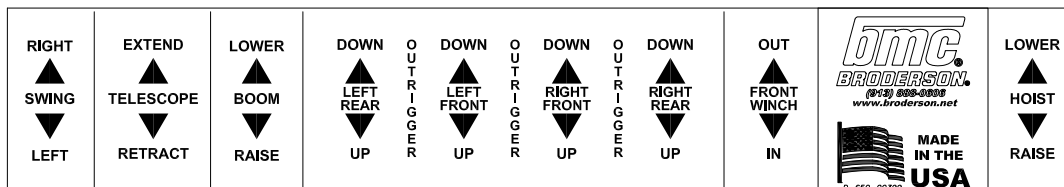

- 1- **Swing:** Pulling back on the lever will rotate the boom to the operator's left; pushing forward will rotate it to the operator's right.
- 2- **Telescope:** Pulling back on the lever will retract the boom; pushing forward will extend the boom.
- 3- **Boom:** Pulling back will raise the boom; pushing forward will lower it.
- 4- **Outriggers:** The four outriggers may be operated simultaneously or in pairs--left-hand or right-hand. Special attention must be given to avoid hitting personnel or obstacles.
- 5- **Front Winch (Optional):** Pulling back will pay winch line in; pushing forward will pay winch line out.
- 6- **Hoist:** Pulling back on the lever will raise load line; pushing forward will lower load line.

All controls may be used for simultaneous operation to achieve combinations of movements. Some controls must be used together. For instance, the boom telescope and the hoist controls must be used together to maintain clearance between boom and load line hook.

Avoid holding a control lever in the open position after the function has reached the end of its travel. This will impose unnecessary stresses on the components and heat the hydraulic system.

THREE-MODE STEERING FUNCTIONS

The IC-100 is equipped with three-mode steering: four-wheel round steering can be used for making tight turns, two-wheel rear steering should be used for traveling long distances and crab steering can be used for maneuvering in tight places. A switch on the dashboard sets the mode. Electronic sensors and controls automatically align the wheels when a new mode is selected, as the wheels are steered past the centered position.

SEQUENCE OF OPERATION

DRIVING THE VEHICLE

The following procedure is recommended for driving the vehicle:

1. Perform the daily inspection and test. (See Page 3-4)
2. Apply park brake.
3. Place transmission control lever in neutral.
4. Start engine and allow a warming period.

5. While warming the engine, set up the Rated Capacity Limiter configuration.
6. Stow boom over front.
7. Pull hoist line snug.
8. Retract outriggers fully.
9. Step on the brake pedal.
10. Release park brake lever.
11. Shift transmission to desired gear.
12. Place forward/reverse lever in desired position.
13. Release brake and press on accelerator pedal.
14. Slow down when making turns.

CAUTION

Driving a unit equipped with four-wheel drive on hard surfaces such as concrete or asphalt may cause premature tire wear.

15. If equipped with four-wheel drive, minimize driving the unit on hard surfaces such as concrete or asphalt.
16. Set park brake and lower outriggers or chock wheels to park.

WARNING

Engine exhaust contains carbon monoxide, a poisonous gas that is invisible and odorless. Breathing engine exhaust fumes can cause death or serious illness. Do not run the engine in enclosed areas without adequate ventilation.

OPERATING THE CRANE

The following procedure is recommended for placing the crane in operation:

1. Perform daily inspection and test. (See Page 3-4)
2. Apply park brake.
3. Place transmission control lever in neutral.
4. Start engine and allow a warming period at low RPM.
5. While warming the engine, set up the Rated Capacity Limiter configuration.
6. Move accelerator pedal from medium to full speed.
7. Set all outriggers fully down on firm, level surface. Use timber or steel plate cribbing under outrigger shoes as needed on soft or uneven surfaces. Outriggers should be set during all crane operations except for pick and carry.
8. Meter the controls when beginning or ending movement. This prevents suddenly starting or stopping, which causes unsafe load swinging and shock loads on the equipment. The control should be slightly actuated to begin movement and then slowly increased to desired speed. Metering can be improved by coordinating with the accelerator pedal.
9. Release accelerator during idle time.

NORMAL GAUGE READINGS

Level Indicator: Do not operate crane if it is not level.

Fuel: Do not allow tank to become empty. The engine will be difficult to restart and may require "bleeding" of diesel injectors. Keep fuel tank full when idle to prevent condensation in tank.

WARNING

Vapors can be formed inside a fuel tank and cause a buildup of pressure that can result in a sudden expulsion of gasoline and gasoline vapors from the filler neck when the fuel cap is removed from a hot tank. Remove cap slowly. Fuel spray may cause injury.

RATED CAPACITY LIMITER (RCL)

A Rated Capacity Limiter is installed on the crane to assist the operator in estimating loads and measuring load radii. Please read the RCL Operation Manual for complete instructions on operation of the system. Following are some additional operating tips.

Always be aware that the RCL can stop boom movement at capacity load conditions and in two-blocking conditions. Use good judgment in controlling the speed of boom movements to prevent shock loads and swinging loads.

If the RCL system stops the crane movement, there are various remedies that may be used to restart operation. If the hook is two-blocked, it should be lowered using the hoist control, if safe. The BOOM RAISE and TELESCOPE RETRACT may also be used if this is safer. In some unusual circumstances it may be necessary to swing the boom before lowering the load. If you are sure this will not cause an overload, you can turn the override key that is under the left instrument panel and swing the boom to a safer position.

If the load is the maximum for the loadline or attachment, the load should be set down in a safe place using the hoist lower control and the load or attachment changed. Telescope retract may also be used and swing may be used, if safe, as described in the preceding paragraph. DO NOT USE THE BOOM RAISE CONTROL as this may increase the overload.

If the load is at the maximum allowable load radius, the boom can be raised or retracted to a safe radius or the load may be lowered to a safe place using the hoist control. If the boom extension is at its angle limit, the boom must be raised or the load hoisted down.

If the boom is fully lowered until it stops, (about 0°) the RCL will show an overload condition because the boom lift pressure sensors cannot read a useful pressure in this condition. To remedy this, raise the boom slightly. Or, if the boom is fully raised, (about 70°) the RCL may show an overload condition because the pressure in the boom lift cylinder is sensed to be an overload. To correct this condition, the override key may be turned and held and the boom lowered just slightly. Then check for other conditions before lowering further.

If there is a malfunction of the RCL or Anti-Two-Block system that causes loss of boom movement and cannot be remedied by the procedures above, the override key switch under the dashboard may be required to move the boom.

WARNING

We recommend the emergency override switch be used with discretion. Improper or careless use of this switch can cause damage to the crane and endanger people and property. The operator who uses the switch in an emergency should use good judgment.

There is a light on the dashboard to warn that one or more outriggers is not fully extended when using the ON OUTRIGGERS setup on the RCL. Check the light daily when the outriggers are down and check to see that there is no load on the hook by raising and lowering each outrigger about three inches. The light should come on when an outrigger is up.

CRANE CAPACITY

Before lifting loads, the operator must read the **Crane Capacity Chart** and adhere to the load capacities and radii of handling given. The information provided on this chart is based on stability, structural strength and hydraulic capacity.

To operate the crane safely, the operator must know the weight of the load and handling devices and the radius of the lifting operation. The crane must not be loaded beyond the specifications of the capacity chart except for test purposes as provided in ASME B30.5 Section 5-2.2. The person responsible for the lift must be sure that the load does not exceed the crane ratings at any radius at which the load may be during the entire lifting operation. The weights of the hooks, blocks, downhaul weights, slings, and other handling devices must be added with the load.

The **Rated Capacity Limiter (RCL)** on the crane is intended to assist the operator in estimating loads and measuring load radii, and to alert the operator to impending overload conditions. The use of the Rated Capacity Limiter does not replace the requirements of the preceding paragraph. Verified weights and measured radii must take precedence over the Rated Capacity Limiter readings. Please read the RCL Operation Manual.

The Rated Capacity Limiter displays a load, load radius and boom angle that are obtained from electronic calculations using readings from pressure, length and angle sensors. These readings cannot be exact and should be treated as estimates. In general, the smaller the load and the higher the boom angle, the larger the percent of error.

Be aware that the electronic and mechanical components cannot be 100% fail-safe. Do not consider the system as a substitute for good judgment, training, experience or accepted safe operating practices. The operator is solely responsible for operation of the crane. Setting the Rated Capacity Limiter for the configuration of the crane is necessary before starting a lift. If incorrectly set, the system will not alert the operator to an impending overload, possibly resulting in the loss of life or destruction of property.

If the Rated Capacity Limiter is inoperative or malfunctioning, repair or recalibration of the unit must be done as soon as reasonably possible. The person responsible for lifts must establish procedures for determining load weights and radii, and conduct the lifts according to the second paragraph above.

The Rated Capacity Limiter is designed to stop crane functions that could cause an overload or two-blocking. These are: BOOM LOWER, TELESCOPE EXTEND, HOIST RAISE, SWING LEFT and SWING RIGHT. Great care must be exercised when handling a load near capacity or near a two-blocking condition. If the boom is being lowered or swung, the load will tend to swing if the Rated Capacity Limiter stops the boom movement. If the load is moving too fast, the sudden stopping by the system can cause dangerous load swinging, which can cause death or injury to personnel or property damage by impact with the load or by the crane tipping.

NOTICE

Under certain load conditions, torsion induced in the chassis can cause it to twist. This may result in an opposite-side outrigger or tire lifting free from the supporting surface. This is most likely to occur when the boom is positioned over one corner of the machine. The condition does not indicate a loss of stability when working within the limits of the capacity chart. Provided the crane capacity has not been exceeded, operation may continue without restriction.

WARNING

The Rated Capacity Limiter can suddenly stop the boom lower and swing functions, causing the load to bounce or swing. Use great care when handling a load near capacity limits or near a two-blocking condition.



CRANE CAPACITY CHART DEFINITIONS AND RULES:

The load radius is the horizontal distance from the centerline of boom rotation (the center of the turntable when it is level), to the vertical load line with the load suspended. Because of deflections of the boom and carrier, the load radius increases when a load is hoisted from its resting place. The load radius may be measured with a measuring tape. If the desired load radius falls between two load radii on the chart, it is recommended to use the load radius with the lower capacity and not try to interpolate between the numbers.

Load capacity ratings on this equipment are given on the basis that operations are to be conducted on firm and level terrain and in a safe environment. These capacity ratings are reduced in proportion to the deviation from the prescribed conditions. Any unfavorable environmental condition, such as soft, sloping or uneven terrain, high wind, or hazardous surroundings constitutes a deviation.

The main boom capacities are given in direct relation to the radius at which the load is being handled. Boom extension capacities depend on the boom angle as well as the load radius. The capacities shown on the capacity chart are the maximum allowable at the indicated radius. The greatest load that may be handled by the BMC IC-100 is 20,000 pounds (9000 kg), but only at a 5-foot (1.5 m) radius and on outriggers. All variances of loads and radii of handling are shown on the crane capacity chart. A metal chart is attached near the operator's seat and a laminated chart is included in the literature compartment for the express purpose of informing the operator when a load can or cannot be safely handled.

The capacities shown in the 360° ROTATION columns of the capacity chart apply to the entire 360° rotation of the boom and are maximum allowable at the indicated radius. The capacities OVER FRONT are limited as follows:

On Outriggers: Boom rotation is limited to an arc of 15° either side of the crane centerline.

On Rubber: Boom rotation is limited to the boom centered over front.

Note that the 360 DEGREE ROTATION capacities at some load radii are much less than the OVER FRONT capacities. The least stable position of the boom is over the side of the crane. Use great care when swinging a load from the front or rear of the crane toward the side of the crane. The load must be known in order to assure that the crane will not tip.

CRANE CAPACITY CHART IC-100-3A

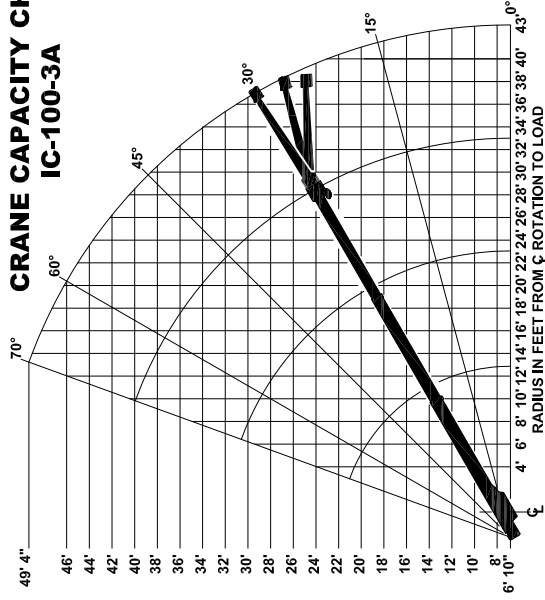

LOAD RADIUS FEET	360° ROTATION		ON OUTRIGGERS		OVER FRONT	
	ON RUBBER	ON OUTRIGGERS	ON RUBBER	ON OUTRIGGERS	ON RUBBER	ON OUTRIGGERS
5	9400	17000	11200	20000	20000	20000
6	8000	14800	9900	15600	11200	11200
8	6000	11200	7900	6600	8700	8700
10	4500	8700	6900	5300	6900	6900
12	3400	6900	5900	4100	5900	5900
14	2700	5900	5100	3200	5100	5100
16	2100	5100	4400	2600	4500	4500
18	1700	4400	3700	2200	4000	4000
20	1400	3700	3100	1900	3500	3500
22	1100	3100	2700	1600	3200	3200
24	1000	2700	2400	1400	2900	2900
26	800	2500	2000	1100	2400	2400
30	600	2000	1600	1000	1900	1900
33	500	1700	1400	800	1700	1700
34	400	1600	1300	700	1600	1600
36	300	1400	1100	600	1400	1400
38	200	1300	1000	500	1300	1300
40	200	1100	900	500	1200	1200
43	---	900	500	500	1500	1500

* USE 0° FOR STRAIGHT BOOM EXTENSION. USE 15°, 30° OR 36° FOR OFFSET BOOM EXTENSION. WITH THE LOAD APPLIED.

LOAD RADIUS IS THE HORIZONTAL DISTANCE FROM THE CENTER OF ROTATION OF THE UNLOADED CRANE TO THE VERTICAL LOAD LINE WITH THE LOAD APPLIED.

EXCEEDING CAPACITY RATINGS OR APPLYING SIDE LOADS TO THE BOOM OR BOOM EXTENSION IS NEGLIGENT, IS HAZARDOUS, AND VOID WARRANTY.

CAUTION: BOOM EXTENSION LOADS MUST NOT EXCEED MAIN BOOM CAPACITY. DO NOT PICK & CARRY WITH LOADS ON BOOM EXTENSION. CAPACITIES ON OUTRIGGERS ARE 85% OF TIPPING LOADS. CAPACITIES ON RUBBER ARE 75% OF TIPPING LOADS. CAPACITIES BELOW BOLD LINE ARE LIMITED BY TIPPING. OTHER CAPACITIES ARE LIMITED BY STRUCTURAL OR HYDRAULIC CAPABILITY.

DECK CAPACITY 14000 LBS. WITH EMPTY BOOM RETRACTED OVER FRONT. DECK LOADS MUST BE CENTERED BEHIND FRONT AXLE. SPEED MUST BE LESS THAN 3 MPH. MAXIMUM TRAVEL 200 FT. IN 30 MINUTES ON SMOOTH PAVEMENT.

PICK AND CARRY WITH THE SHORTEST PRACTICAL BOOM, CENTERED OVER THE FRONT. OPERATE WITH THE BOOM AS LOW AS POSSIBLE. WITH THE LOAD CLOSE TO GROUND, PICK AND CARRY CAPACITIES ARE FOR SMOOTH, LEVEL, PAVED SURFACE.

THE BOOMS ON THIS UNIT ARE ALL STEEL AND HAVE NO LINE VOLTAGE RATING. NO ELECTRICAL INSULATION VALUE.

LOAD HOOKS, DOWNHULL WEIGHTS, HOOK BLOCKS AND OTHER LOAD HANDLING DEVICES SHALL BE CONSIDERED PART OF THE LOAD.

MAXIMUM HYDRAULIC PRESSURE 3000 PSI.

BOOM EXTENSION DEDUCT: 100 LBS. WHEN STOWED ON BASE BOOM.

ENSURE ANTI-TWO BLOCK SWITCH IS FUNCTIONAL AFTER DEPLOYING OR STOWING BOOM EXTENSION.

OPERATION: 1. READ AND UNDERSTAND OPERATION MANUAL BEFORE OPERATING CRANE.

2. CHECK LEVEL OF HYDRAULIC OIL AND ENGINE OIL DAILY.

3. CHECK UNIT FOR VISIBLE DEFECTS AND LOOSE PARTS.

4. SET VEHICLE PARK BRAKE SECURELY.

5. EXTEND OUTRIGGERS TO SOLID FOOTING AND LEVEL CRANE.

6. OPERATE ALL HYDRAULIC CONTROLS SLOWLY AND SMOOTHLY. AVOID SUDDEN STOPS AND STARTS.

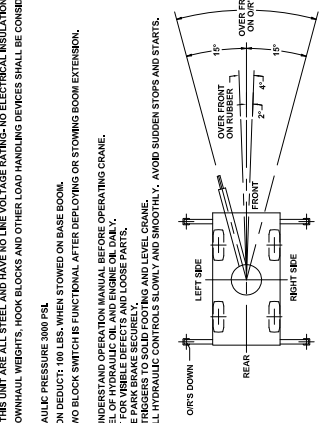

THE LOAD HOIST LINE ON THIS UNIT MUST BE 6/16" DIA. 5 X 1/8" EEP-RRL-HWRC WIRE ROPE (OR EQUIVALENT) WITH A MINIMUM BREAKING STRENGTH OF 35,000 LBS. 140 FT. LONG.

TIRE PRESSURE: 135 PSI FOR 10R15, 18PR, L.R. J. RADIAL TIRE
110 PSI FOR 10.00-15, 16 PR, L.R. H. BIAS TIRE
120 PSI FOR 39 X 11-15, 16 PR, BIAS, MINING TIRE.

TORQUE WHEEL NUTS TO 500 FT. LBS. (THESE CONDITIONS MUST BE MAINTAINED TO HANDLE RATED LOADS ON THIS CRANE)

MODEL NO. SERIAL NO. DATE OF MFR.

IC-100-3A

BRODERSON MANUFACTURING

CORP. LENEXA, KANSAS

65401085

CRANE CAPACITY CHART IC-100-3A METRIC

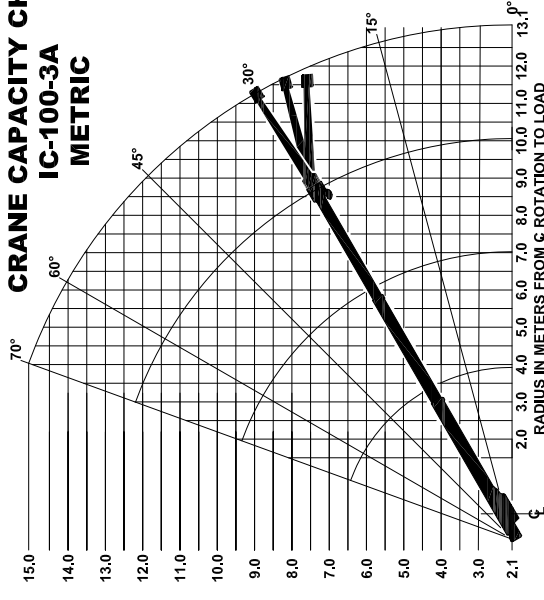

LOAD RADIUS METERS	360° ROTATION		ON OUTRIGGERS		OVER FRONT	
	ON RUBBER	ON OUTRIGGERS	ON RUBBER	ON OUTRIGGERS	ON RUBBER	ON OUTRIGGERS
1.5	4200	7700	5100	9000	9000	9000
2.0	3300	6200	4200	6400	4900	4900
2.5	2600	4900	3500	4900	4000	4000
3.0	2100	4000	3000	4000	3300	3300
3.5	1600	3300	2500	3300	2800	2800
4.0	1300	2800	2100	2800	2400	2400
5.0	900	2200	1400	2200	2000	2000
5.5	700	2000	1200	1800	1800	1800
6.0	600	1700	1000	1500	1500	1500
7.0	400	1300	800	1100	1100	1100
7.5	400	1200	700	1000	1000	1000
8.0	300	1100	600	900	900	900
9.0	300	900	500	800	800	800
10.1	200	700	400	700	700	700
10.5	100	700	300	600	600	600
11.0	100	600	300	500	500	500
11.5	100	500	200	400	400	400
12.0	---	500	200	300	300	300
13.1	---	400	200	200	200	200

* USE 0° FOR STRAIGHT BOOM EXTENSION. USE 15°, 30° OR 36° FOR OFFSET BOOM EXTENSION. WITH THE LOAD APPLIED.

LOAD RADIUS IS THE HORIZONTAL DISTANCE FROM THE CENTER OF ROTATION OF THE UNLOADED CRANE TO THE VERTICAL LOAD LINE WITH THE LOAD APPLIED.

EXCEEDING CAPACITY RATINGS OR APPLYING SIDE LOADS TO THE BOOM OR BOOM EXTENSION IS NEGLIGENT, IS HAZARDOUS, AND VOID WARRANTY.

CAUTION: BOOM EXTENSION LOADS MUST NOT EXCEED MAIN BOOM CAPACITY. DO NOT PICK & CARRY WITH LOADS ON BOOM EXTENSION. CAPACITIES ON OUTRIGGERS ARE 85% OF TIPPING LOADS. CAPACITIES ON RUBBER ARE 75% OF TIPPING LOADS. CAPACITIES BELOW BOLD LINE ARE LIMITED BY TIPPING. OTHER CAPACITIES ARE LIMITED BY STRUCTURAL OR HYDRAULIC CAPABILITY.

DECK CAPACITY 6500 kg. WITH EMPTY BOOM RETRACTED OVER FRONT. DECK LOADS MUST BE CENTERED BEHIND FRONT AXLE. SPEED MUST BE LESS THAN 3 MPH. MAXIMUM TRAVEL 60 m IN 30 MINUTES ON SMOOTH PAVEMENT.

PICK AND CARRY WITH THE SHORTEST PRACTICAL BOOM, CENTERED OVER THE FRONT. OPERATE WITH THE BOOM AS LOW AS POSSIBLE. WITH THE LOAD CLOSE TO GROUND, PICK AND CARRY CAPACITIES ARE FOR SMOOTH, LEVEL, PAVED SURFACE.

THE BOOMS ON THIS UNIT ARE ALL STEEL AND HAVE NO LINE VOLTAGE RATING. NO ELECTRICAL INSULATION VALUE.

LOAD HOOKS, DOWNHULL WEIGHTS, HOOK BLOCKS AND OTHER LOAD HANDLING DEVICES SHALL BE CONSIDERED PART OF THE LOAD.

MAXIMUM HYDRAULIC PRESSURE 207 bar.

BOOM EXTENSION DEDUCT: 50 kg WHEN STOWED ON BASE BOOM.

ENSURE ANTI-TWO BLOCK SWITCH IS FUNCTIONAL AFTER DEPLOYING OR STOWING BOOM EXTENSION.

OPERATION: 1. READ AND UNDERSTAND OPERATION MANUAL BEFORE OPERATING CRANE.

2. CHECK LEVEL OF HYDRAULIC OIL AND ENGINE OIL DAILY.

3. CHECK UNIT FOR VISIBLE DEFECTS AND LOOSE PARTS.

4. SET VEHICLE PARK BRAKE SECURELY.

5. EXTEND OUTRIGGERS TO SOLID FOOTING AND LEVEL CRANE.

6. OPERATE ALL HYDRAULIC CONTROLS SLOWLY AND SMOOTHLY. AVOID SUDDEN STOPS AND STARTS.

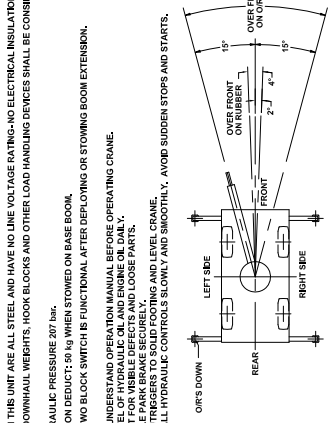

THE LOAD HOIST LINE ON THIS UNIT MUST BE 14 mm 6 X 36-EEP-RRL-HWRC WIRE ROPE (OR EQUIVALENT) WITH A MINIMUM BREAKING STRENGTH OF 156 KN LBS. 42 m LONG.

TIRE PRESSURE: 930 kPa FOR 10R15, 18PR, L.R. J. RADIAL TIRE
760 kPa FOR 10.00-15, 16 PR, L.R. H. BIAS TIRE
830 kPa FOR 39 X 11-15, 16 PR, BIAS, MINING TIRE.

TORQUE WHEEL NUTS TO 680 Nm. (THESE CONDITIONS MUST BE MAINTAINED TO HANDLE RATED LOADS ON THIS CRANE)

MODEL NO. SERIAL NO. DATE OF MFR.

IC-100-3A

BRODERSON MANUFACTURING

CORP. LENEXA, KANSAS

65401091

CAUTION

A capacity load may be carried on the boom, or a capacity load may be carried on the deck, but not at the same time. The total of the percent of deck load and the percent of boom load must not exceed 100%. For example, if the boom load is 100% of its capacity at its current load radius, the deck load capacity is 0%. If the boom load is 60% of the load rating for its load radius, the deck load capacity is 40% of maximum.

CAUTION

The capacities of this crane are based on all outriggers being FULLY EXTENDED to a FIRM, LEVEL surface. The crane may tip at less than capacity loads if operated in the following manner:

- A. Outriggers only partially extended and resting on curbing, shoring, etc. If the outriggers are not all the way DOWN, they are not all the way OUT.
- B. Outriggers extended to a surface that appears to be firm, but is unable to support the outrigger pad at full rated loads. Examples of this type surface are:
 1. Thin or cracked blacktop or concrete.
 2. Dirt that appears dry and firm on top, but is moist or unpacked beneath the surface.
 3. Dirt with a frozen but thin crust.
- C. Crane operated on a hill or sloping surface. Crane will tip at less than rated capacity when load is lifted on downhill side.

CAPACITY EXAMPLE (See Boom Extension Capacity Example Page 2-22)

Refer to the IC-100-3A capacity chart on the preceding page. A load weighing 10,500 pounds (4760 kg) is to be lifted onto the deck of the crane for transport to a new location. We see on the chart that 10,000 pounds (4500 kg) is the maximum load on one-part line, so the sheave block is required. The charts show the weight of the standard sheave block to be 124 pounds (56 kg). The rigger says that two slings are required, weighing a total of 40 pounds (18 kg). The total load is $10,500+124+40= 10664$ pounds, ($4760+56+18= 4834$ kg).

Looking at the 360° ROTATION, ON RUBBER column we see that the load is too heavy for this condition. The OVER THE FRONT, ON RUBBER column shows that we can lift 11,200 pounds (5100 kg) at a 6-foot (1.5 m) load radius. However, this radius is less than the distance from the center of rotation to the front bumper, so the load cannot be lifted this way. This leaves the ON OUTRIGGERS columns. The outriggers should always be used whenever possible anyway. We see that we can lift up to 11,200 pounds (4900 kg) at an 8 foot (2.5-m) load radius, either over the front or over the side. If the load is compact enough to allow the crane within the 8 foot (2.5 m) radius over the front, this is the best position for stability. Checking the chart again, we see that the load is within the deck load limit of 14,000 pounds (6350 kg) and that the travel speed with the load must be limited to creep speed. Creep speed is less than 2 MPH (3 km/h) and defined as not to exceed a distance of 200 ft. (60 m) in a 30 minute period. This is an approved relationship between load, tire pressure, and speed.

CAUTION

AS THE BOOM IS LOADED, DEFLECTION OF THE BOOM, TIRES, ETC., WILL INCREASE THE LOAD RADIUS. BE CONSERVATIVE IN YOUR CAPACITY ESTIMATE.

SHEAVE BLOCK AND DOWNHAUL WEIGHT

The capacity chart shows the approved hoist rope arrangements. The downhaul weight and sheave blocks supplied by Broderson are specially designed to operate the Anti-Two-Block system. Other blocks or downhauls may bypass this system and create a dangerous condition. Notice the load limit for each hoist rope arrangement.

The keeper pins that pass through the sheave plates must be locked in place with cotters to hold the line on the sheaves. The load line must pass through the center of the downhaul, through the wedge socket, and the dead end clamped in the block as shown in the figure below.

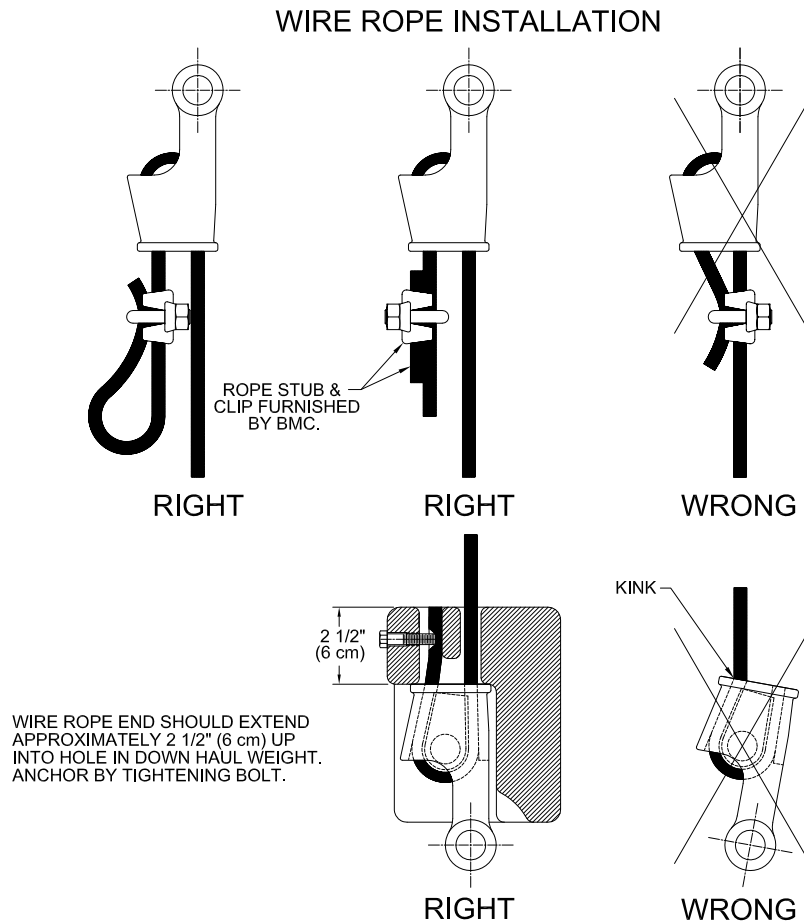

When resting the downhaul or sheave block on the ground for changing it, use the following procedure to prevent fouling the load line on the hoist. Raise the boom about 5 feet (1.5 m) and lower the hoist until the hook nearly touches the ground. Then lay the hook on the ground by lowering the boom, not the hoist.

TWO-PART LINE REEVING

For loads above 10,000 pounds (4500 kg), the sheave block must be used. The wedge socket should be pinned to the two-part-line lug, as shown in the figure. The dead end of the rope in the wedge socket should be clamped, as shown in the figure. The clamp must not be used on the live part of the rope. This will seriously weaken the rope by metal fatigue over a number of cycles. The sheave block should hang straight, and the top of the block should meet the boom sheave plates squarely when pulled up snugly.

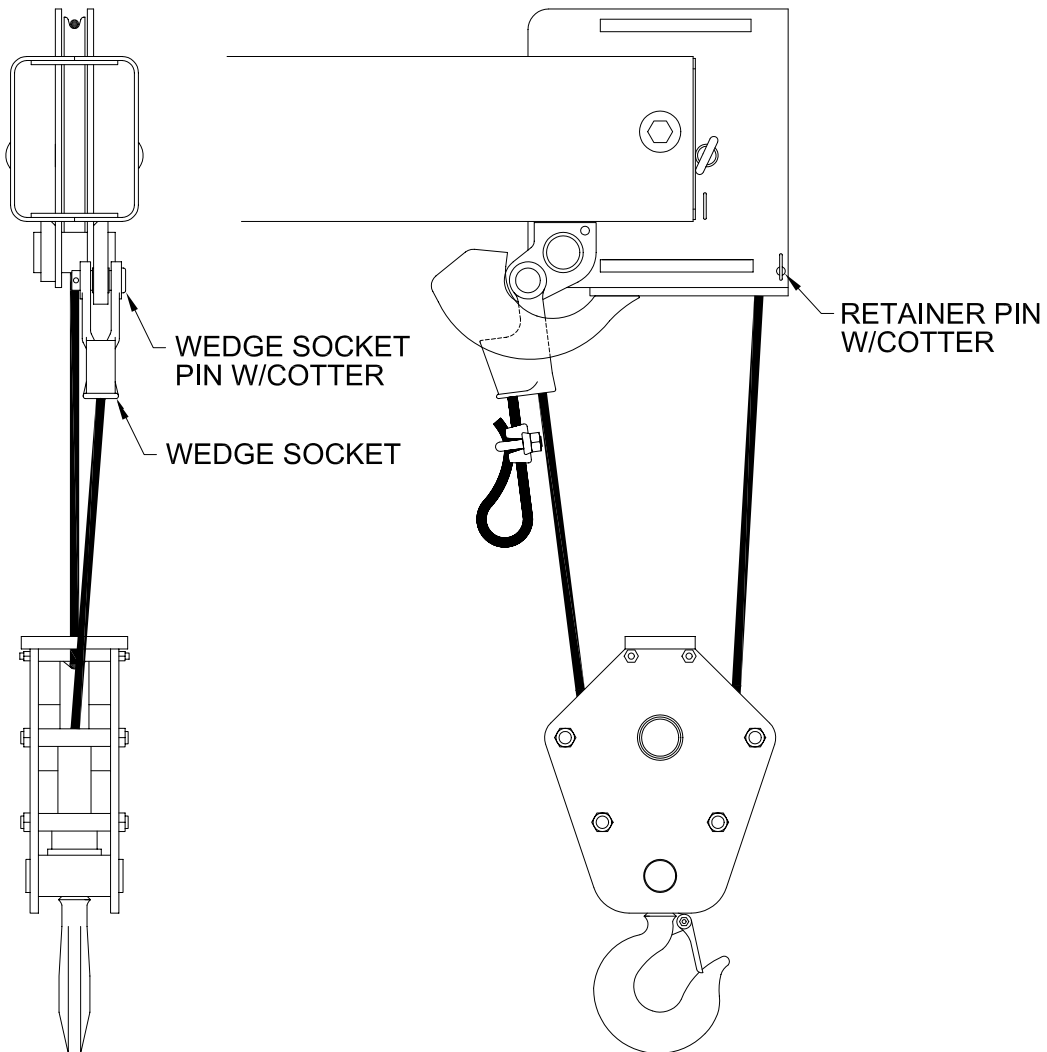

	⚠ WARNING
	FALLING OBJECTS DO NOT USE ROPE CLIP ON LIVE SIDE OF THE LOAD HOIST ROPE. DEATH OR SERIOUS INJURY CAN RESULT FROM A SERIOUSLY WEAKENED ROPE CAUSED BY A ROPE CLIP.

SAFETY DEVICES

There are certain safety devices on the IC-100 that are designed to maintain control of a load even though power or hydraulic line failure should occur. The operator should understand the function and operation of these devices so that a continual check on their performance can be made.

OUTRIGGER CYLINDER CHECK VALVE:

A double-acting check valve is built into each of the outrigger cylinders. This valve holds the outrigger in the extended position should power or hydraulic line failure occur. This valve has no adjustment. If an outrigger creeps up while supporting a load, there is an internal leak in the valve or in the outrigger cylinder piston seal. In either case, maintenance is required.

BOOM ELEVATION CYLINDER HOLDING VALVE:

A single-acting holding valve is built into the cylinder barrel. This valve holds the boom in the elevated position should power or hydraulic pressure line failure occur. This valve is adjustable to hold the desired load. If the boom creeps down with loads up through maximum capacity, this valve should be adjusted. If adjustment fails to correct the problem, there is an internal leak in the holding valve or the hydraulic cylinder. Refer to the maintenance instructions.

BOOM TELESCOPE CYLINDER HOLDING VALVE:

A single-acting holding valve is flange-mounted to the cylinder rod end. This valve holds the cylinder in the extended position should power or hydraulic pressure line failure occur. This valve is adjustable to hold the desired load. If the boom creeps in under load, this valve should be adjusted. If adjustment fails to correct the problem, there is an internal leak in the holding valve or the hydraulic cylinder. Refer to the maintenance instructions.

ANTI-TWO-BLOCK SYSTEM:

This system prevents damage to the hoist rope and machine components from accidentally pulling the load hook against the boom tip. A pivot arm-actuated electric switch is connected through a cable reel mounted on the boom to a solenoid dump valve in the hydraulic circuit. This valve will dump the HOIST RAISE, TELESCOPE EXTEND and BOOM LOWER, SWING LEFT and SWING RIGHT circuits. No other circuits are affected. These circuits are returned to normal operation by operating the HOIST LOWER or TELESCOPE RETRACT control.

An emergency override switch is provided so the boom can be operated in case of system failure. This key-operated switch is located under the left side of the instrument panel.

WARNING

We recommend the emergency override switch be used with discretion. Improper or careless use of this switch can cause damage to the crane and endanger people and property. The operator who uses this key in an emergency should use good judgment.

OPTIONAL EQUIPMENT

INSTALLING BOOM EXTENSION ON TIP OF BOOM:

1. Set the outriggers.
2. Raise and extend boom 30 feet (9 m) above the ground, paying out load line until hook is just above ground.
3. Position boom over front, lower and retract boom leaving the load line on the ground.
4. If the sheave block is installed, remove it.
5. Remove load line from tip sheaves and lay over opposite side of stored boom extension.
6. Make sure the front stow pin is in place and both sets of attach pins are removed from the lugs.
7. Remove the rear stow pin and swing the boom extension away from the rear end of the boom until the attaching inner lugs mesh on the near side of the boom.
8. Insert the attach pins in these inner lugs and retain them with the hairpin cotters.
9. Remove the front stow pin and swing the boom extension around to the front until the outer lugs mesh.
10. Insert the attach pins in their outer lugs and retain them with hairpin cotters. To insert pin, it may be necessary to rock boom extension.
11. Replace the rear stow pin and front stow pin in their brackets for storage and insert their hairpin cotters.
12. Lay the load line over the main boom and extension tip sheaves and insert the cable retainer pins and cotters.
13. Install the downhaul weight, wedge socket and swivel hook on the load line if they are not already installed.
14. Disconnect the Anti-Two-Block wiring cable from the switch on the main boom tip and connect it to the cable connector on the boom extension base.
15. Check the Anti-Two-Block System for proper operation.
16. Store the Boom Extension in reverse order.
17. Lay the load line back in the boom tip sheaves and insert both retainer pins & cotters.
18. Replace all of the pins in their lugs for storage and insert their hairpin cotters.
19. Install the sheave block on the load line, if desired.

SETTING THE OFFSET ANGLE ON THE OFFSETTABLE BOOM EXTENSION:

1. The boom extension must be installed on the main boom tip and the load line, downhaul weight and wedge socket installed on the boom extension, and secured with all of the retainer pins.
2. Draw the load line taut with the hoist by pulling the downhaul weight against the bottom of the tip sheave plates while holding the Anti-Two-Block override switch under the control panel.

WARNING

Be careful not to operate the TELESCOPE lever while overriding the Anti- Two-Block system. This may break the load line and allow the boom extension and downhaul weight to fall, causing death or serious injury to personnel.

3. Remove the offset index pin from the boom extension knuckle. To loosen the pin it may be necessary to rock the boom extension tip up and down manually while maintaining the proper tension in the load line.
4. Lower or raise the load line with the hoist until the 0, 15, or 30 degree offset holes align in the knuckle.
5. Insert the index pin in the knuckle and retain it with the hairpin cotter.

STOWING THE OFFSETTABLE BOOM EXTENSION:

1. If the boom extension is offset to 15 or 30 degrees, return it to the zero offset position as described above.
2. Reverse the procedure described in steps 7 through 14 in the Boom Extension installation procedure on previous page.

CAPACITY EXAMPLES FOR BOOM EXTENSION

The MAIN BOOM and BOOM EXTENSION capacity charts must both be considered when using the boom extension. The smaller capacity specified by the two charts must be used. Refer to the IC-100-3A Capacity Chart on page 2-15 for the following examples:

In this first example the boom is elevated to 30° over the side of the crane. The boom extension is offset to 15°, and the load radius is 20 feet (6 m). The outriggers are fully extended on concrete pavement and the crane is level. The column for 360° ROTATION, ON OUTRIGGERS shows the capacity at the 20 feet (6 m) load radius to be 3700 pounds (1700 kg). The column for 10 FOOT (3 METER) BOOM EXTENSION - STRAIGHT OR OFFSET, MAIN BOOM ANGLE 30° shows the capacity at the 15° boom extension angle to be 2400 pounds (1090 kg). Since 2400 pounds (1090 kg) is less than 3700 pounds (1700 kg), the load (including the downhaul weight and slings) must be limited to 2400 pounds (1090 kg).

In the second example the boom is elevated to 45° over the side of the crane. The boom extension is offset to 30°, and the load radius is 30 feet (9 m). The outriggers are fully extended on concrete pavement and the crane is level. The column for 360° ROTATION, ON OUTRIGGERS shows the capacity at the 30 feet (9 m) load radius to be 2000 pounds (900 kg). The column for 10-FOOT (3 METER) BOOM EXTENSION - STRAIGHT OR OFFSET, MAIN BOOM ANGLE 45° shows the capacity at the 30° boom extension angle to be 2500 pounds (1130 kg). Since 2000 pounds (900 kg) is less than 2500 pounds (1130 kg), the load must be limited to 2000 pounds (900 kg).



FRONT AUXILIARY WINCH:

The front auxiliary winch is mounted behind the front bumper and is controlled from the operator compartment. The winch, with 75 feet (23 m) of 3/8-inch (9.5 mm) diameter 6X36-IWRC-EIP wire rope (15,100 pound (67 kN) breaking strength) and 3-ton (2700 kg) hook, has a single-part-line capacity of 5000 pounds (2270 kg) on the first wrap.

The front auxiliary winch is designed for the following uses:

1. As a tag line for restraining loads on the boom load line during pick-and-carry operation.
2. To drag loads on the ground to a position where they may be safely lifted with the boom.
3. To pull the crane out of mud or other obstacles.
4. To pull a smaller vehicle that is stuck.

WARNING

The front winch is not designed for lifting personnel or loads.

Observe the following safety rules:

1. Never lift or carry personnel with the winch and wire rope.
2. Do not allow anyone to stand near or under the load being moved.
3. Be sure the cable is securely anchored in the drum and that at least 5 wraps of rope remain on the drum to insure against the rope pulling out of its anchor.
4. Stand clear of a loaded winch cable. If it breaks, it can be very dangerous.
5. Keep hands clear of the winch and any sheaves that the cable passes over when the winch is being operated.



PINTLE HOOKS:

Available Pintle Hooks allow the crane to tow other disabled vehicles and trailers, and drag loads.

1. Observe the capacity ratings marked near the hook when towing.
2. Exceeding the capacities can damage the drivetrain.
3. Use slow and smooth motions to avoid shock loads or overrunning loads. Make sure other vehicle is occupied and controlling the vehicle being towed.

Pintle Hooks also allow the crane to be towed.

1. Use appropriately sized straps or chains.
2. Place transmission in Neutral. Utilize an Operator to activate brakes as needed and steer the crane while being towed.
3. Do not exceed a towing speed of 5 MPH (8 km/h).

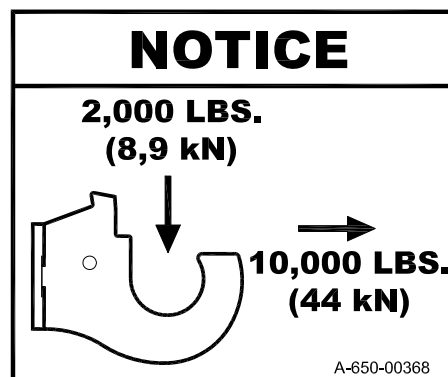





















































OPTIONAL FOUR-WHEEL DRIVE:

The optional 4-Wheel Drive is a full time system and cannot be disengaged. The front axle includes a drop box. The drop box sends power to a drive shaft connected to the rear axle. Both axles include wet-disc brakes inside the axle hubs. Mining tires and diesel engine are required for use with optional four-wheel drive.

SWITCH AND INDICATOR SYMBOLS ON BMC CRANES

The following list shows the symbols used to label switches and indicators on BMC cranes. Most symbols are derived from the ISO 3767-1:1998(E) standard. Not all symbols will be included on your BMC crane.

	On/Start		Windshield washer switch
	Off/Stop		Windshield defroster switch
	Battery not charging		Heater switch
	Hour meter		Air conditioner switch
	Read operator's manual		Ventilation fan switch
	Sound level notification		Parking brake is set
	Headlights (main/high beam)		4-wheel (round) steer
	Work light		Rear-wheel steer
	Hazard lights		Crab steer
	Rotating beacon or strobe lights		2-wheel drive
	Turn signals left/right		4-wheel drive
	Windshield wiper switch		Steering wheel tilt

	Tire pressure		Engine oil pressure low
	Lift point		Engine coolant fill location
	Tie-down point		Engine coolant temperature high
	Transmission oil fill location		Engine coolant low level mark
	Transmission oil pressure		Engine air filter restriction indicator
	Transmission oil temperature		Engine start
	Brake fluid fill location		Engine idle set
	Hydraulic oil low-level mark		Check engine
	Hydraulic oil filter restriction indicator		Stop engine
	Hydraulic temperature gauge		Wait to start/ engine preheat/ grid heater/ glow plug switch
	Hydraulic oil temperature high		Gas fuel only
	Hydraulic oil pressure gauge OR hydraulic oil pressure low		Diesel fuel only
	Positive polarity		Fuel level gauge
	Negative polarity		Drain

MAINTENANCE

SAFETY RULES

1. Lower load and boom, shut down engine, remove key and put it in a safe place. Place warnings on the ignition switch and crane controls to prevent unauthorized starting or movement during maintenance. Disconnect battery when disabling crane. Disconnect battery, RCL and engine electronic module (gas engine only) when welding on crane.
2. Relieve hydraulic pressure when working on hydraulic parts by cycling the controls with the engine shut down.
3. Allow fluids and parts to cool before working on them.
4. Read maintenance instructions before beginning work.
5. Do not check for hydraulic leaks with hands. If a mist of hydraulic oil is noticed around a line or component, use cardboard or other material to check for location of leaks. High pressure fluid leaking from a small hole, can be almost invisible, yet have enough force to penetrate the skin. If injured by escaping fluid, see a doctor at once. Serious reaction or infection can occur.
6. Wear safety glasses and shoes.
7. Do not wear loose-fitting or torn clothing.
8. Remove rings and other jewelry.
9. Wear heavy leather gloves when working on wire rope.
10. Keep fingers, clothing and hair away from moving parts.



11. To prevent falls, clean areas of crane that are stepped on for access to crane parts. Wear slip resistant footwear.
12. Avoid placing body parts in pinch points. Use tools that extend through the pinch points when possible. Block the moving parts securely when it is necessary to work in pinch point areas.
13. When inflating or adding air to a tire, place a tire cage over the tire and use a clip-on inflator chuck with an extension hose that will permit standing behind the tire tread when inflating.
14. Do not work on any machine that is supported only by jacks or a hoist. Always use adequate blocks or jack stands.

15. If it is necessary to work on the boom or outriggers in an un-stowed condition, block them to prevent them from dropping unexpectedly.
16. Use a hoist when lifting components that weigh 50 pounds (22 kg) or more. Follow all hoist and rigging safety rules.
17. Do not use lower grade fasteners if replacements are necessary.
18. When reinstalling wiring or plumbing after repairs, be sure that it will not be damaged by rubbing against sharp, rough or hot surfaces or edges.
19. Never use a rope clip on live side of the load hoist rope. This will seriously weaken the rope. Death or serious injury can result from the misuse of a rope clip on the hoist rope.
20. Replace any instruction or warning placards that are lost or damaged or are not readable.
21. Always replace all guards and covers after working on the crane.
22. After working on the hydraulic system, remove air from the lines and cylinders involved by cycling them full stroke with the engine running until the functions operate smoothly.
23. When welding on the crane or on anything connected to the crane by wire rope or other conducting link, disconnect the battery, the Rated Capacity Limiter display and computer and the engine electronic control module (gas engine only). When welding on the boom or turntable assembly, remove the cable reel and any other electronic components bolted to these assemblies.
24. When using pressure spray to clean the crane, cover all electronic components with sheets of plastic to protect them from spray.
25. Do not allow antifreeze to contact skin. Rinse off spills immediately with plenty of water. Antifreeze is highly toxic if ingested.
26. Always disconnect negative cable first and refasten last to prevent accidental short through chassis components.

CAUTION

Even with low voltage electrical systems, severe arcing can occur. Electrical shock or component damage can result from contact with energized conductors. Use caution when working with any electrical device.

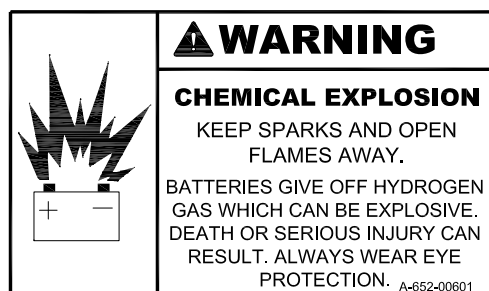

MAINTENANCE

The Broderson IC-100 Industrial Crane will perform better and longer if a program of inspection, lubrication, adjustment and general preventive maintenance is followed. We recommend the following schedule:

NEW UNIT INSPECTION AND TEST

The following inspection and test should be made before placing the unit on the job. This will insure that no damage or loss of operating capability occurred during shipment.

1. Check for physical damage.
2. Check for leaks at fittings and drips under chassis.
3. Check radiator coolant level.
4. Check engine oil level.
5. Check hydraulic oil reservoir level.
6. Check transmission oil level.
7. Check fuel tank level.
8. Check tire pressure.
9. Check for loose pins, bolts, and retainers.
10. Check for operation of foot brake.
11. Check for operation and adjustment of parking brake. (See page 3-22.)
12. Check for operation of accelerator pedal.
13. Start engine.
14. Check power steering for operation. Check all steering modes.
15. Check operation of transmission gear selector lever.
16. Check lights and turn signals for operation.
17. Test-drive unit and check for normal operation.
18. Check operation of hydraulic outriggers.
19. Check boom swing.
20. Check boom elevation.
21. Check boom extension (pay out hoist cable during power extension).
22. Perform cable break in procedure. (See page 3-10.)
23. Check anti-two-block system for proper operation and cutout of boom functions.
24. Perform a load test according to the Rated Capacity Limiter Operation Manual.
25. Check the outrigger warning light for proper operation as described on page 2-12.
26. Check operation of Drum Rotation Indicator.

WARNING

When the Rated Capacity Limiter is inoperative or malfunctioning, it must be repaired as soon as reasonably possible. When a lift must be made without a properly functioning load indicator or RCL, the designated lift supervisor must establish procedures for determining load weights and load radii and conducting the lift safely.

OPERATOR INSPECTION AND TEST

An operator, in the course of normal operation, should make certain observations, inspections and tests to assure that the unit is ready to perform safely.

Daily:

1. Check levels of engine oil, coolant and transmission fluid.
2. Drain water from diesel fuel filter.
3. Check air cleaner intake system for cracks or looseness.
4. Check general condition of tires.
5. Visually inspect for loose pins, bolts, physical damage and leaks.
6. Check hydraulic hoses, particularly those that flex during crane operation.
7. Check hydraulic oil level.
8. Check fuel level.
9. Check hydraulic filter indicator gauge after running at least twenty minutes.
10. Check hydraulic service brake operation.
11. Check parking brake operation.
12. Check power steering operation.
13. Observe chassis for normal driving operation.
14. Observe boom operation for normal power and speed.
15. Check load line and hooks for damage.
16. Check condition of sheaves and load line retainers.
17. Check anti-two-block system for proper operation.
18. Check horn, back-up alarm and outrigger alarm for proper operation.
19. Check operation of all transmission gears, forward and reverse.
20. Clean all glass (if equipped) and check for cracks.
21. Check operation of all warning and safety devices.
22. Check operation of Rated Capacity Limiter according to the RCL User Manual.
23. Check the outrigger warning light for proper operation as described on page 2-12.
24. Check Drum Rotation Indicator for proper operation.

Weekly:

1. Check tire pressure: 110 PSI (758 kPa) bias belted, 135 PSI (930 kPa) radial, or 120 PSI (827 kPa) for mining tire.
2. Check for loose wheel nuts.
3. Check lights and turn signals.
4. Check power steering lines for damage.
5. Check brake lines for damage.
6. Check operation of horn.
7. Check operation of hoist brake for smoothness.
8. Check outrigger holding valves for operation.
9. Check boom topping holding valve for operation.
10. Check swing gears for looseness or backlash.
11. Check boom extension cylinder holding valve for operation.
12. Check operation of windshield wipers (if equipped).
13. Boom extension (if equipped) properly pinned with retainers in place.
14. Check all steering modes.
15. Clean all glass and check for cracks.

WARNING

Vapor can form inside a fuel tank and cause a buildup of pressure. This can result in a sudden expulsion of gasoline and vapor from the filler neck when the gas cap is removed from a hot tank. Remove cap slowly. Fuel spray may cause injury.

IC-100 MAINTENANCE CHECKLIST

Refer to the component maintenance section of this manual and to the engine operator's manual for complete instructions.

50 HOUR INTERVAL:

1. 50 hour lubrication as shown on lube schedule.
2. Inspect wire rope thoroughly.
3. Inspect for physical damage and leaks.
4. Clean radiator fins and check coolant level.
5. Check tire pressure and condition.
6. Check fluid levels in engine, transmission, hydraulic tank, and brakes.
7. Clean air filter inlet screen and empty the pre-cleaner dust cup.
8. Inspect air intake and exhaust systems for cracks, leaks and loose bolts.
9. Change engine oil and filter after first 50 hours and at 250 hours thereafter.
10. Torque cylinder head bolts. (See engine manual)
11. Adjust engine valve clearance. (See engine manual)
12. Check tension and condition of fan and alternator belts.
13. Check the hydraulic filter indicator with warm oil; change element if indicated.
14. Check diesel engine idle and maximum speed and adjust if necessary.
15. Check swing gear and pinion fit and gear train backlash.
16. Check swing bearing and gearbox bolt tightness. (See page 3-21)
17. Check axle mounting bolts and pins.
18. Torque wheel mounting nuts to 500 pounds-foot (678 Nm).
19. Check for loose pins or pin retainers.
20. Check brake lines and steering lines for damage.
21. Inspect sheaves and hooks for damage or excessive wear.
22. Visually inspect welds on boom, turret and outriggers.
23. Perform a load test according to the Rated Capacity Limiter User Manual.
24. Check operation of outrigger warning light as described on page 2-12.
25. Check tension and condition of engine belts.

250 HOUR OR 3 MONTH INTERVAL:

1. 50 hour maintenance.
2. 50 and 250 hour lubrication.
3. Clean engine and battery.
4. Change engine oil and filter.
5. Clean crankcase breather.
6. Clean and inspect distributor and ignition wires.
7. Clean the air filter. (Clean element every 100 hours if used in dusty conditions.)
8. Check engine mounts and radiator mounts.
9. Inspect all bolts on the machine for tightness.
10. Visually inspect all welds for cracks.
11. Check hydraulic fittings and centerpost for leaks.
12. Check park brake cable adjustment.
13. Clean the two steering alignment proximity sensors' tips with a rag.

500 HOUR OR 6 MONTH INTERVAL:

1. 50 and 250 hour maintenance.
2. 50, 250 and 500 hour lubrication.
3. Change fuel filter element.
4. Change air filter element.
5. Check antifreeze for protection level and cleanliness.
6. Inspect engine fan and belt.
7. Check water pump and connections for leaks.
8. Check fuel pump and connections for leaks.
9. Change hydraulic filter element, if not changed in the last 250 hours and inspect oil from element.
10. Change transmission filter element and inspect oil from element.
11. Check condition of all operational and warning placards.
12. Torque mounting bolts on swing bearing and gearbox, winch and axles. (See page 3-23)
13. Inspect boom sections for signs of overload, excessive wear, or other damage.
14. Check axle toe-in.

1000 HOUR OR 12 MONTH INTERVAL:

1. 500 hour maintenance.
2. 50, 250, 500, 1000 hour and 12 month lubrication.
3. Adjust engine valve clearance per engine manual.
4. Perform engine maintenance specified in engine manual.
5. Change hydraulic fluid and filter and clean breather and reservoir.
6. Change transmission fluid and filter and clean strainer.
7. Replace vapor block inside slip ring. See turret sub-assembly in parts manual.

24 MONTH INTERVAL:

1. 12 month maintenance.
2. Pressure test engine cooling system.
3. Flush cooling system.
4. Change engine thermostat.
5. Fill with new coolant and distilled water.
6. Perform engine maintenance specified in engine manual for 24 month interval.

S/N: _____ HOURS: _____ DATE: _____ BY: _____

COMMENTS & PARTS REQUIRED: _____

LUBRICATION

SWING BEARING LUBRICATION:

There is one grease zerk in a hole on the left-hand side of the turntable base plate. This should be used to lubricate the bearing every 50 hours. Rotate the turntable about 45 degrees and pump some grease into the zerk. Repeat until the turntable has rotated two revolutions. Use about 6 ounces (180 cc) of grease each time the bearing is lubricated.

Also, lubricate the gear teeth of the swing bearing at the 50-hour interval. Remove the pinion cover. Brush open gear grease, such as Mobilkote-S, on the teeth on each side of the pinion at four places around the bearing. Rotate the boom several times and check the coverage of the grease on all of the teeth. Replace the pinion cover.

TRANSMISSION:

Check the transmission fluid with the dipstick and add fluid through the dipstick tube as required. Use Mobil ATF Type F or equivalent. Transmission factory service manuals are available from Broderson. Order BMC Part Number 990-00021.

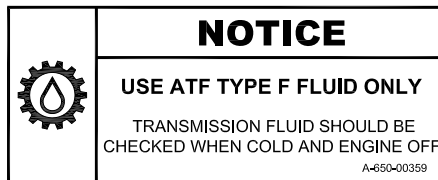

DRIVE AXLES--HUBS AND DIFFERENTIALS:

Maintain lubricant to levels shown here with Mobil 424 or equivalent.

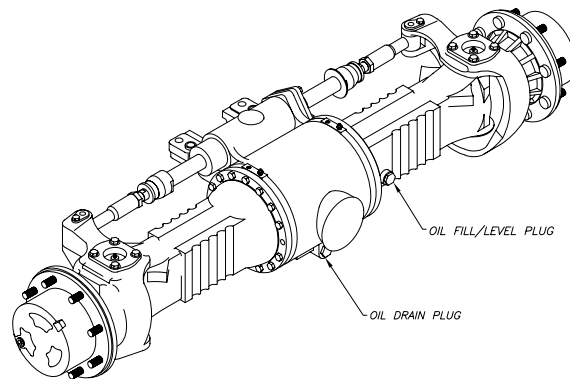

FLUID VOLUME CHART:

HYDRAULIC RESERVOIR - 25 Gallons (95 L)

FUEL TANK - 20 Gallons (76 L)

PLANETARY HOIST - 2.5 Quarts (2.4 L)

FRONT AUXILIARY WINCH - 2 Pints (1 L)

PLANETARY DRIVE AXLE – 11 Quarts (10 L) Center Section & 0.75 Quart (.7 L) each end.

TRANSMISSION, POWERSHIFT - 17.5 Quarts (16.6 L)

ENGINE COOLING SYSTEM - 15 (14 L) to 17 (16 L) Quarts depending on engine and heater.

IC-100 LUBRICATION CHART

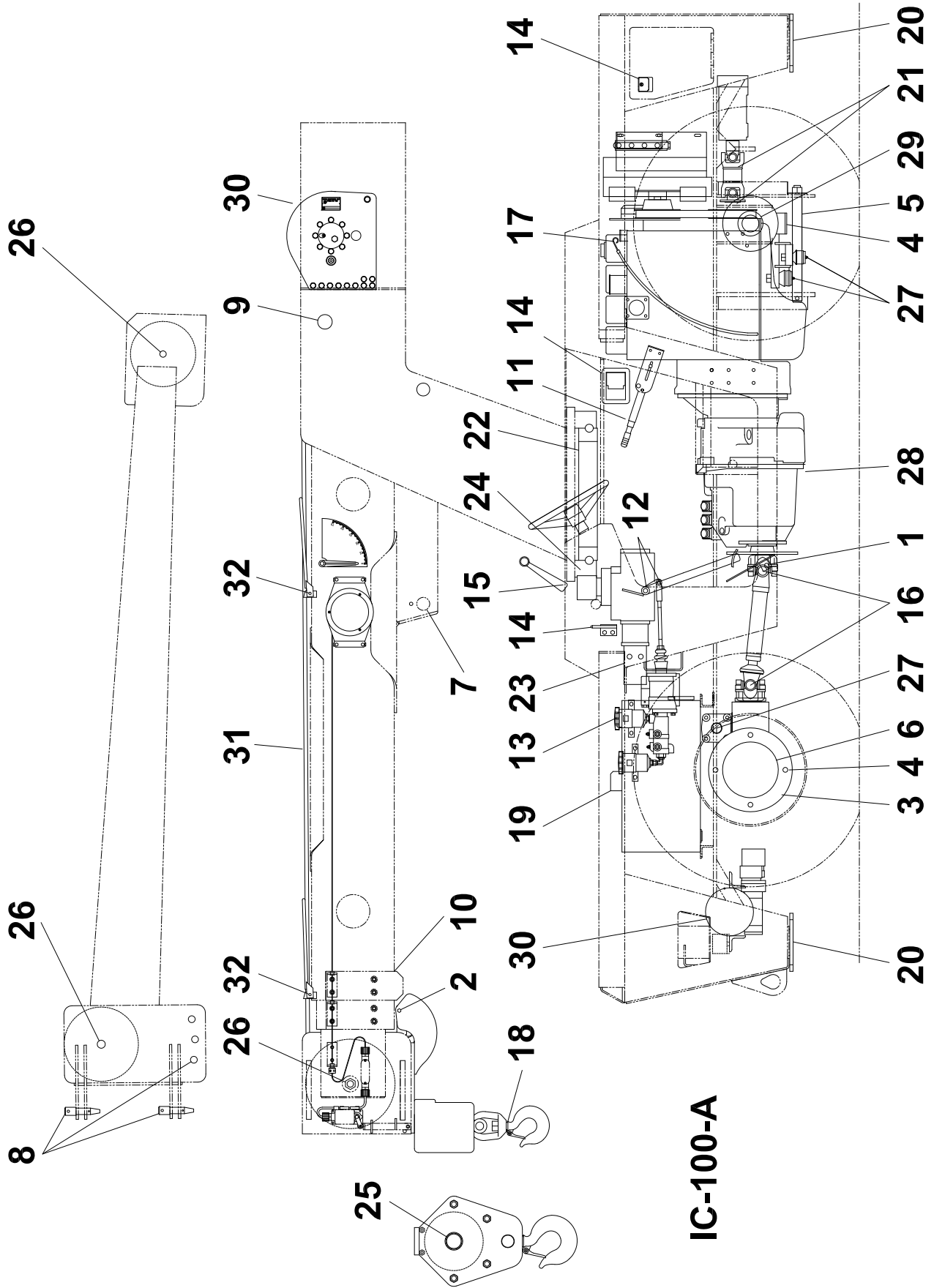

IC-100-A

IC-100 LUBRICATION SCHEDULE

ITEM	DESCRIPTION	LUBE	LUBRICATION INTERVALS					NOTES
			50 HOUR	250 HOUR	500 HOUR	1000 HOUR	MONTHS	
1	Accelerator Pedal	MPG			X			1 Zerk (Diesel)
2	Anti-Two-Block Arm	SIL	X					2 Points - Oilcan
3	Axle Differential	UTF	X				12	Check @50, Change @12 Mo.
4	Axle Kingpins	MPG	X					8 Zerks
5	Axle Pivot Pin	MPG			X			1 Zerk Std., 2 Zerks 4x4
6	Axle Planetary Hubs	UTF	X				12	Check @50, Change @12 Mo.
7	Boom Cylinder Pins	MPG			X			2 Zerks
8	Boom Ext. Pins	MPG	X					Wipe on
9	Boom Hinge Pin	MPG			X			1 Zerk
10	Boom Rub Pads	SIL	X					Spray or Wipe
11	Brake Lever, Parking	SIL	X					
12	Brake Linkages	SIL	X					
13	Brake Reservoir	DTE	X					Check @50, Change When Brakes are Serviced
14	Cab Hinges & Latches	SIL	X					
15	Control Valve Links	SIL	X					
16	Drive Shaft Joints	MPG	X					3 Zerks Std., 6 Zerks 4x4
17	Engine Oil (Gas Engine)	EO	X	X			3 Max.	Check Daily, Change @50 then @250 Hrs. or 3 Mo. Max.
18	Hook Swivel & Pin	SIL	X					
19	Hydraulic Oil	HO	X			X	12 Max.	Check Daily, Change @1000 Hours or 12 Mo. Max.
20	Outrigger Legs	MPG	X					Wipe on Legs
21	Pump Shaft	MPG	X					2 Zerks
22	Rotation Bearing	MPG	X					1 Zerk*
23	Rotation Gearbox	WGO		X			24	Check @250, Change @24 Mo.
24	Rotation Gear Teeth	OGG	X					Brush On*
25	Sheave Block	MPG			X			2 Zerks
26	Sheave Pins	MPG			X			1 Zerk Std, 2 Boom Extension
27	Steering Rod Ends	MPG			X			6 Zerks Std, 4 Zerks 4x4
28	Transmission	TPF	X				12 Max.	Check @50, Change @12 Mo.
29	Wheel Bearings, Rear	WBG					12	Clean & Repack
30	Winch(es)	MPL		X			12	Check @250, Change @12 Mo.
31	Wire Rope	2-X	X					Spray, Brush or Soak*
32	Wire Rope Retainers	SIL	X					

*See Procedures in Manual

LUBE SYMBOLS

TPF	- ATF Type F	MPG	- Multi-Purpose Gun Grease
2-X	- AMOVIS #2-X	MPL	- Multi-Purpose Gear Lube, SAE 80W-90
UTF	- Mobil Fluid 424 or Equivalent	OGG	- Open Gear Grease, Such as Mobilkote S
DTE	- Mobil DTE 10 Excel 15 or Equivalent (Do not use brake fluid)	SIL	- Silicone Lube, Aerosol with Concentrating Tube
EO	- Engine Oil - See Specs in Engine Manual	WBG	- Wheel Bearing Grease
HO	- Hydraulic Fluid - See Specs in Hyd. Sec.	WGO	- Worm Gear Oil, Exxon Cylesstic TK 460

HOIST CABLE LUBRICATION

The hoist cable is a wire rope and should be cleaned and lubricated every 50 hours of normal operation, and more frequently when used in dirty or corrosive environments. Whenever the rope is dirty or dry, it should be serviced. The rope should be cleaned with solvent and compressed air or solvent and rags. A wire brush may be used for difficult areas.

The recommended lubricant is AMOVIS #2-X. It should be sprayed or dripped onto the rope where it is bent, as it passes over the tip sheave, as it is spooling onto the hoist. Use an appropriate ladder or steps to access the tip sheave. Wrap rags around the wire rope behind the sheave and swab the excess oil that is carried along on the rope. Always wear heavy leather gloves when handling wire rope.

CABLE WEDGE (FLANGE MOUNT) INSTALLATION & INSPECTION

The following steps will assure that the wire rope (aka hoist rope, hoist cable, or load line) winds smoothly and evenly on the hoist and will yield greater safety and longer rope life.

If the cable is not sufficiently compact during the initial assembly phase when it is loaded, it may become caught up in the turns below, and damaged.

1. Position rope spool such that rope will wind from the top of the spool, to the top of the hoist drum. Winding from the bottom of the spool will introduce a reverse bend and may introduce torque into the rope.
2. Never “pull loops through,” as this will introduce a kink in the rope and severely shorten effective service life. If excess rope accumulates on the floor, straighten it to remove loops & eliminate tension without introducing torque or a kink.
3. Introduce the cable end into slot positioned on the drum, and then into pocket “A.”
4. Fold the cable around wedge “B.”
5. Secure the cable and wedge in the slot by pulling firmly.

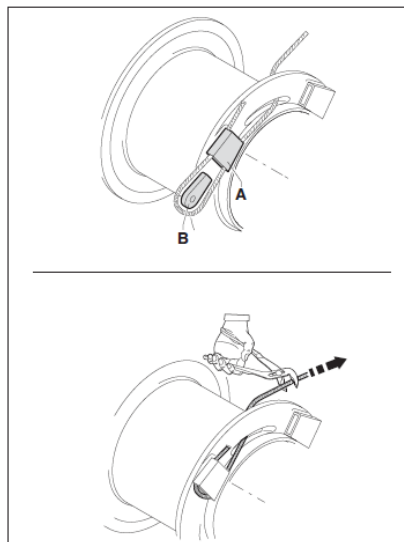

CAUTION

For a correct assembly, it is necessary to have a minimum pre-load of 5% of the cable breaking force. The cable breaking force depends on the diameter and of the cable type, and it must be indicated on the cable certificate.

6. Slowly rotate the hoist while applying tension on the cable in front of the boom. Wear heavy leather gloves and wrap rags around the cable to wipe off any dirt from the cable. Keep hands away from the sheaves and hoist drum while the cable is moving.
7. After two turns of the drum, stop the hoist and push the cable into the drum groove if it has come out.
8. Slowly rotate the drum until the first layer of cable is on the drum. If any gaps between the rope appear, back up the hoist and rewind. There must be no gaps in the first layer.
9. After the first layer is on the drum, the hoist may be turned a little faster until the remainder of the cable is installed.
10. Leave about 40 feet (12 m) of cable on the ground to install the sheave block. The sheave block must be used for cable preloading to ensure enough rope can be spooled off the hoist drum. See the *Operation Section* for instructions on reeving and wedge socket attachment.
11. Install the cable retainer pins and cotters in the tip sheave plates.
12. For the cable preloading, set the outriggers and attach a load of about 3000 pounds (1300 kg). EXTEND the boom fully. Position the load at a 10-foot (3m) load radius over the side of the crane. HOIST UP and LOWER the load three times and check winding of the rope on the hoist.
13. Attach about 8000 pounds (3600 kg) and repeat. Be sure that the cable winds evenly.
14. Never lift more than the rated load on the Capacity Chart for the parts-of-line and type of wire rope being used.
15. Lubricate the cable as recommended in the *Wire Rope Lubrication* section. Inspect, maintain, and replace the cable in accordance with ASME B30.5, Section 5-2.4.

WARNING

All cut ends on ropes must be welded. Failure to weld cut ends may result in rope failure, furthermore leading to property damage, injury, or death.

HYDRAULIC SYSTEM

The IC-100 hydraulic system consists of two subsystems, driven by a double pump with a single inlet port. The 16 GPM (61 L/min) vane pump supplies the hydrostatic steering function and the boom and outrigger functions. The hoist and brake booster are powered by the 32 GPM (121 L/min) vane pump.

The boom, outriggers, hoist and optional front winch are controlled by one valve assembly. The 16 GPM (61 L/min) pump flow enters the steering flow control valve first and then flows into the left-hand section of the control valve assembly supplying the swing, telescope, boom and outrigger sections. The flow from the 32 GPM (121 L/min) pump enters the brake booster flow control valve first and all but 4 GPM (15 L/min) is directed to the inlet section to the left of the hoist valve. Adjustment procedures for the crane hydraulic functions are given on page 3-18 through 3-20. The schematic of the hydraulic system is shown on the next page.

STEERING SYSTEM

The three-mode steering system is shown in the schematic on the next page. The IC-100 steering system is a load-sensing, demand-type system that takes only as much flow as is needed when steering and directs the excess flow to the control valve for boom and outrigger functions. The priority flow-control valve is in the line between the 16 GPM (61 L/min) pump section and control valve.

Oil from the 16 GPM (61 L/min) section of the pump goes into the priority valve at port "P." When no steering is required, the entire flow goes through the priority valve and leaves through port "EF" to the crane valve. The crane operating speed is not affected, since there is no loss of volume passing through the priority valve.

When the steering wheel is turned, the load-sensing line signals the priority valve to divert the required amount of oil to the steering control unit to meet the steering system requirements. The excess oil, not required for steering, flows to the crane control valve as usual. Since the amount of oil required for steering is usually a small portion of the pump output, the crane control valve is always operational while the unit is being steered. Crane operation speed is reduced such a slight amount it is usually not noticed.

The steering control unit is non-load reactive. This means that bumps, curbs, and obstacles cannot change the steering angle and are not felt in the steering wheel. It also means that the wheels do not re-center when the steering wheel is released. The steering wheel must be turned back to center at the end of a turn.

There is a check valve in the pressure line between the priority valve and the steering control unit. This prevents pressure in the steering cylinders from venting back into the pressure line when the pressure is low. This eliminates steering wheel kickback when the steering wheel is released. The steering system pressure was set at 1900 PSI (131 bar) at the factory, and this should not need adjustment.

The three steering modes are selected by a switch on the dashboard which activates the automatic alignment system. Electronic proximity sensors and logic controls delay the switching of the steering mode until the wheels are centered. The proximity sensors should be cleaned periodically with a rag to prevent dirt buildup from blocking their operation.

IC-100-A JIC SCHEMATIC

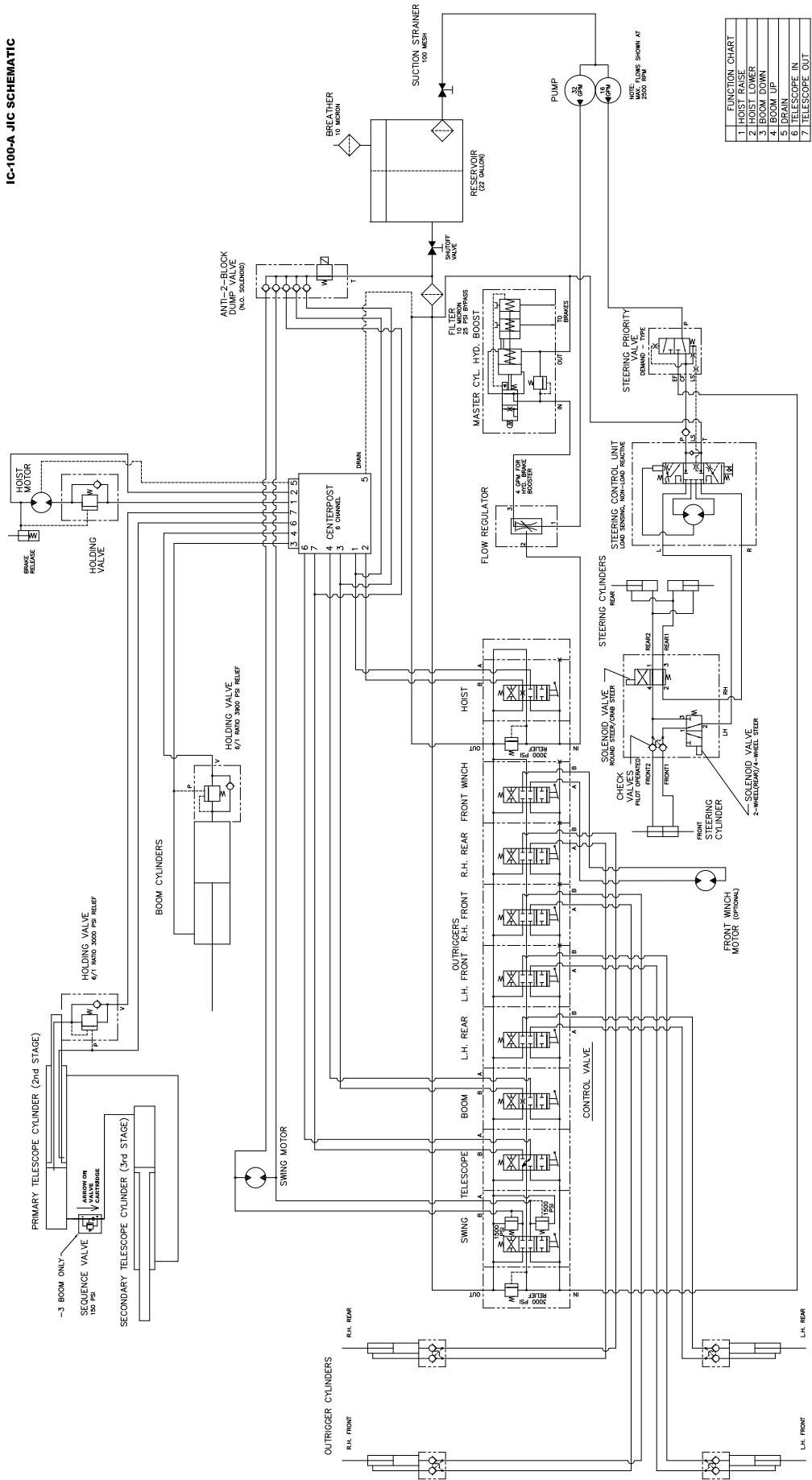

IC-100-A METRIC JIC SCHEMATIC

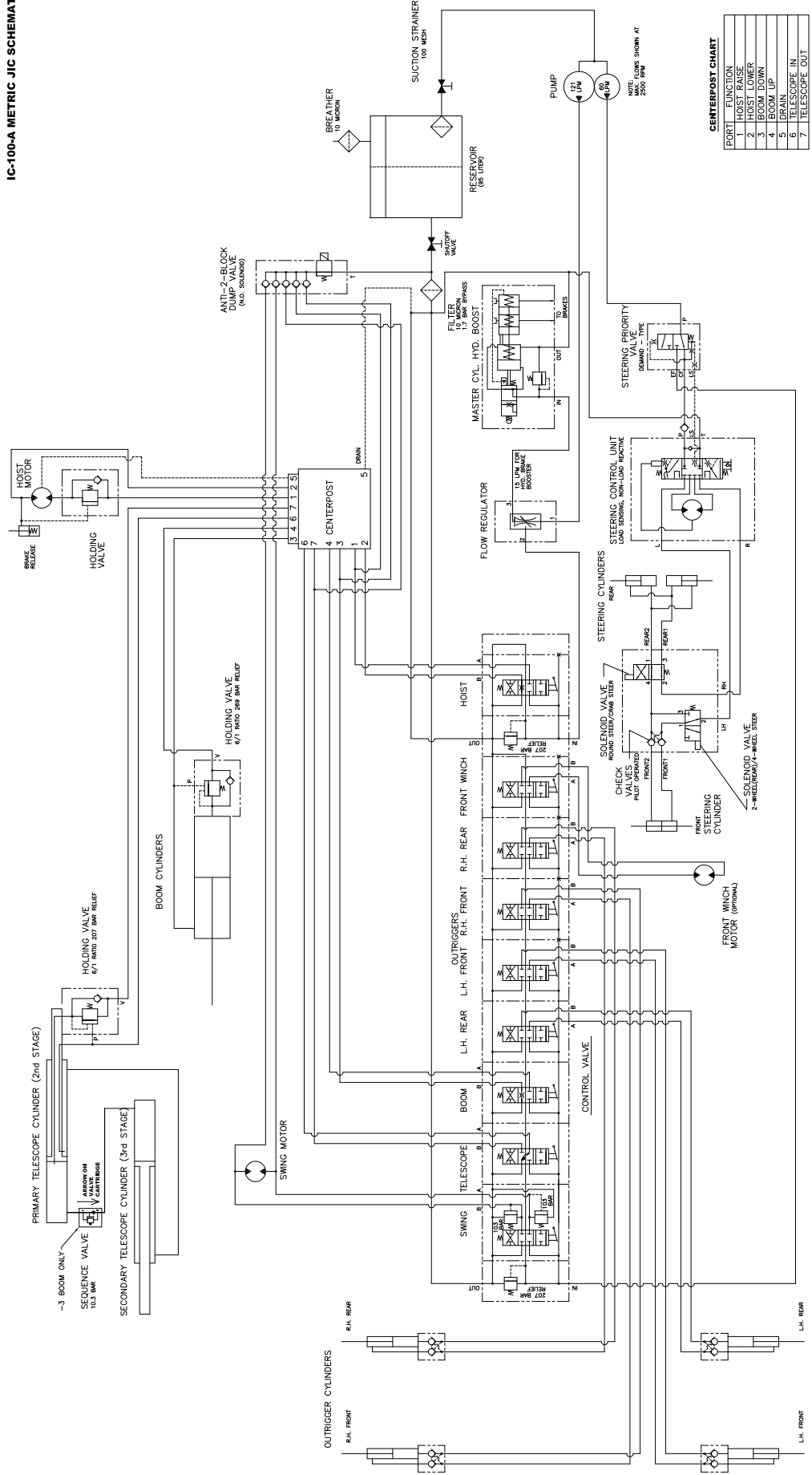

CENTERPOST CHART

PORT	FUNCTION
1	HOIST RAISE
2	HOIST LOWER
3	BOOM DOWN
4	BOOM UP
5	DRAIN
6	TELESCOPE IN
7	TELESCOPE OUT

CARE OF HYDRAULIC OIL

The hydraulic system contains many highly pressurized, precision components. To protect these, it is very important to keep the hydraulic oil clean, at proper temperature, within the oil specification and to the proper fill level.

The IC-100 is equipped with a 100-mesh suction strainer, a breather filter, a 10-micron return-line filter and a 25-gallon (95 L) tank. The filter must be changed whenever the filter indicator gauge under the control panel points to the red sector at full engine speed or at 500 hours, or six months maximum. Note: The oil should be warmed by at least 15 minutes of normal operation to get a good reading. The indicator should be checked daily.

The filter is located under the crane to the rear of the hydraulic tank. Clean the filter and the surrounding parts with pressure washer before changing, to prevent dirt from getting into the clean oil tube. To minimize oil loss, close the shutoff valves under the tank.

BE SURE SHUTOFF VALVES ARE FULLY OPENED BEFORE STARTING ENGINE.

Remove the filter element and catch the hydraulic oil in a clean container. Pour the remaining oil out of the old element into the clean container and inspect the oil for water and excessive contaminants. If water is found, the oil should be changed in the reservoir and purged out of the cylinders. If excessive particles are found, the source should be located and fixed, and the oil should be purged.

Lubricate the new element seal and install the new element. Open the shutoff valves. Run the engine and check for any leaking around the seal.

The hydraulic oil should be changed every 1000 hours or once a year, whichever is sooner. Wash the oil tank and filters before changing the oil. Retract the telescope, boom and outrigger cylinders. Leave the shutoff valves open and remove the drain plug. Catch the oil and dispose of it properly. Remove the breather from the top of the tank and clean the element with solvent and compressed air. Clean out the tank with solvent and compressed air.

The suction strainer is threaded into the hydraulic tank suction port. To service, drain the oil from the tank. Remove the suction hose from the strainer fitting. Remove the suction strainer by turning the hex bushing counterclockwise. Wash the element in clean solvent and allow to dry. Apply oil to the o-ring on the strainer and reassemble.

Replace the filter as described previously and refill the tank with new hydraulic oil that meets the specifications in the table below. Open the shutoff valves. Start the engine and run it at low idle for 10 minutes, then at high idle for 3 minutes to filter the new oil. Then cycle all of the hydraulic cylinders at low idle and low pressure. Add hydraulic oil to the dipstick full mark, if necessary, with cylinders retracted.

HYDRAULIC OILS FOR IC-100

AMBIENT TEMP RANGE:	-40° to 75°F (-40° to 24°C)	-15° to 110°F (-26° to 43°C)	50° to 130°F (10° to 54°C)
POUR POINT:	-40°F MAX (-40°C MAX)	-15°F MAX (-26°C MAX)	0°F MAX (-18°C MAX)
VISCOSITY INDEX:	140 MIN	95 to 100	95 to 100
VISC. SSU @ 100°F: (38°C)	200 MAX	230 MAX	340 MAX
SSU @ 210°F: (99°C)	44 MIN	47 MIN	53 MIN

EXAMPLES: MOBIL DTE-13 MOBIL AW-46 MOBIL AW-68
MOBIL UNIV.-ATF MOBIL DTE-25 MOBIL DTE-26
TEXAMATIC TYPE F CONOCO SUPER 46 CONOCO SUPER 68
TEXACO HD 46 TEXACO HD 68

OTHER REQUIREMENTS: Must contain rust and oxidation inhibitor, and antifoam and anti-wear agents. Must pass Vickers Vane Pump Test

The IC-100 is factory filled with hydraulic oil for the -15°F(-26°C) to 110°F (43°C) range. If significant portions of time are spent operating below 20°F (-7°C) or above 100°F (43°C), the oil should be replaced with an extreme temperature oil.

The oils shown are compatible with and may be combined with SAE 10W or SAE 20W-20 motor oil if it is necessary to add oil between changes and the recommended oils are not available. These motor oils are not suitable substitutes when changing hydraulic oil because they lack certain additives that are needed for hydraulic system use.

CAUTION

Never add kerosene or other "thinners" to hydraulic oil. These fluids have low aniline points and consequently will cause rapid deterioration of certain packings and seals in the hydraulic system.

CAUTION

Serious damage to the pump will result if it is run with the shutoff valve closed or with insufficient oil level in the reservoir.

Observe the operation of the machine. If the oil is too cold, the machine will be sluggish and should be warmed up further to prevent damage before sustained hard work is attempted. If the oil is too hot, leakage will increase, pump efficiency will go down, and moving parts will not be properly lubricated. If operating temperature is excessive, rapid deterioration of the oil will result and moving parts and seals will wear more quickly. The cause of the excess heat should be determined and corrected. A possible indication of excessive oil temperature is a control valve lever that becomes hard to operate or sticks instead of returning to neutral.

HYDRAULIC SEALS

WARNING

Do not check for hydraulic leaks with hands. If a mist of hydraulic oil is noticed around a line or component, use cardboard or other material to check for location of leak. High pressure fluid leaking from a small hole, can be almost invisible, yet have enough force to penetrate the skin. If injured by escaping fluid, see a doctor at once. Serious reaction or infection can occur.

All hydraulic fittings and hose connections should be kept tight to prevent loss of fluid from the system and unnecessary dripping from the machine. Most hydraulic fittings on the IC-100 crane use o-ring seals, and if tightening the fitting fails to stop the leak, the o-ring should be replaced.

Notes:

1. When installing an o-ring fitting with an adjustable nut and washer, be sure to back off the nut, washer and o-ring as far as possible before threading the fitting into the port. Then turn the fitting into the port as far as possible with fingers and turn it backward until it is oriented properly. Torque the nut with a wrench, while holding the fitting with a wrench.
2. Lubricate all seals before assembling.
3. Take care not to over tighten pipe threads.
4. Do not use Teflon tape to seal pipe threads. Loctite-type (anaerobic) sealant is preferred.

Leaks in component parts, such as pumps, valves and motors, that cannot be stopped by tightening bolts, can usually be stopped by replacing the seals in the component. Seal and packing replacement is the only maintenance which owners should attempt on component parts, unless they have a well-equipped shop with mechanics trained in hydraulic component overhaul.

Leakage in the pump suction line may not cause oil to appear externally, but may allow air to enter the line during operation. The air entrained in the oil will cause pumps to be noisy, and if allowed to continue, can damage the pump. If a pump becomes noisy, immediately check the fluid level in the reservoir and be sure all suction fittings are tight. If noise continues, squirt hydraulic fluid on the suction connections. Listen for a change in the noise and watch for oil being sucked into a small opening in the connection. When the reservoir is full, the shutoff valve is open and all suction connections are tight, most pump noises will disappear. If they do not, a worn or faulty pump is indicated. On a routine basis, all hoses should be checked for wear, deterioration, and physical damage. Defective hoses should be replaced for maximum economy for the user.

PRESSURE SETTINGS

The hydraulic system is divided into two pressure circuits, each having its own protective adjustable relief valve in the inlet sections of the control valve. The functions operated by the control valve sections require different pressures for different functions. These are shown below:

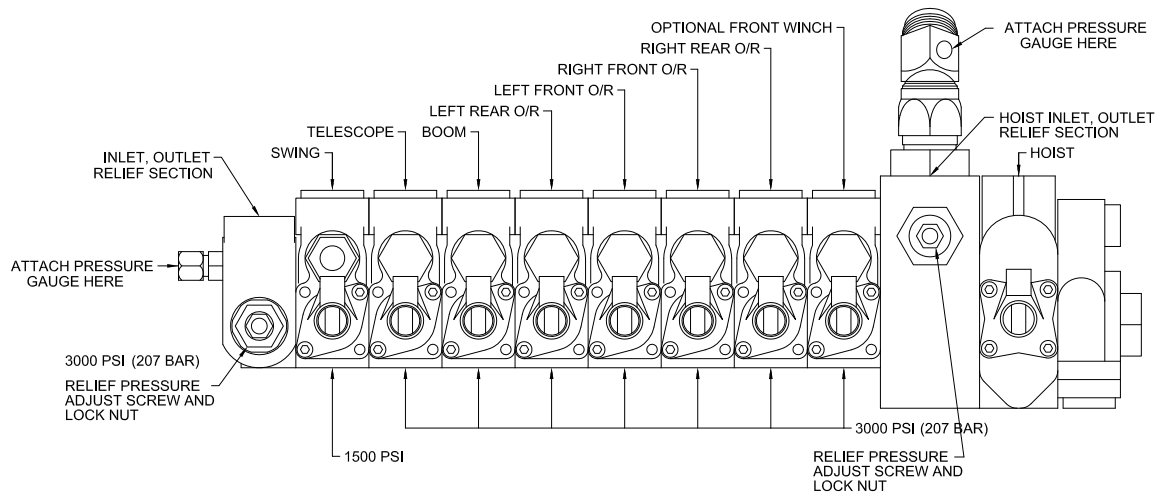

1. Winch Circuit -- 3000 PSI (207 bar) at full flow.
2. Boom and Outrigger Circuit -- 3000 PSI (207 bar) at full flow.
3. Boom swing work ports -- 1500 PSI (103 bar) at full flow.

A good quality pressure gauge with at least a 3000 PSI (207 bar) scale is required to make adjustments properly. A 4000 PSI (275 bar) working pressure hose with adapters to fit the 3/8" tube pressure ports is required to install the gauge where it can be read easily.

The following procedures are suggested when taking pressure readings:

WINCH CIRCUIT:

Remove the 3/8" JIC cap from the fitting on the front of the control valve near the winch control section and install a 4000 PSI (275 bar) pressure gauge. To obtain full flow reading, run pump full speed, pull winch control to RAISE position and hold until maximum reading is made. The anti-two-block override switch must be actuated. If a pressure of 3000 PSI (207 bar) is not possible, check the following:

1. Broken mechanical connection to the pump shaft.
2. Low oil level in the reservoir.
3. Clogged suction filter or shutoff valve not fully opened.
4. Valve spool linkage not allowing control valve to fully open. Valve spool should move 3/8" (10mm) each way from neutral position.
5. Anti-two-block system malfunction.
6. Adjust relief valve by loosening nut on top of relief cartridge above winch gauge port and turning socket-head screw clockwise to increase pressure or counter-clockwise to lower pressure.
7. Foreign particle in pilot operated relief.
8. Worn or defective hydraulic pump.

BOOM AND OUTRIGGER CIRCUIT:

The relief valve pressure setting at the inlet for boom control sections is 3000 PSI (207 bar). This pressure is required for all but the swing control section. Two work port relief valves are installed in the swing section. These relief valves are set at 1500 PSI (103 bar).

The relief pressure at the inlet end of the valve can be adjusted with a wrench and an allen wrench. Loosen the nut and tighten the threaded stem with an allen wrench to increase pressure, and loosen the stem to decrease pressure. Lock in place with the nut. Actuate the BOOM LOWER or TELESCOPE RETRACT function with the cylinder fully retracted when making this adjustment.

While the pressure gauge is attached, the swing function may be checked by capping the two work ports of the swing section and actuating the swing control lever in each direction. If these pressures are improper, the work port relief valve can be removed and shims added or removed as needed. Pressure is changed approximately 100 PSI (7 bar) to 125 PSI (9 bar) for each .010" (.25 mm) shim. Part numbers for the work port relief valves and shims:

9-340-00070	Work Port Relief Valve -- Gresen #7460-002 PS 1500 C
9-340-00032	Shim -- .010" (.25 mm) -- Gresen #0462-001
9-340-00031	Shim -- .020" (.5 mm) -- Gresen #0459-001
9-340-00030	Shim -- .040" (1 mm) -- Gresen #0458-001

BOOM CYLINDER HOLDING VALVE:

A holding valve is directly connected to the base of the boom lift cylinder barrel and to the base of the primary telescope cylinder rod. These valves are designed to hold the boom in position should loss of power or pressure line failure occur.

To check the boom lift cylinder holding valve, set the outriggers, place the boom in the horizontal position over the front of the crane and raise rated load about 6 inches (15 cm) above the ground using the boom lift cylinder (not the hoist). An example of rated load for the IC-100-3A is 5100 pounds (2200 kg) at a 16-foot (5.0 m) load radius with outriggers extended and the boom over the front. Turn the engine off and move the BOOM lever to the LOWER position. If the boom moves down, adjust the holding valve.

WARNING

Before working on the holding valves or plumbing to the lift cylinders, always relieve trapped pressure by lowering the boom fully, turning off the engine, and cycling the BOOM lever.

To adjust the holding valve, loosen the jam nuts on the adjusting screw and tighten the screw until unpowered boom movement stops. Retighten the jam nuts. If adjusting the valve does not help, the cylinder may have internal leakage or the valve may be malfunctioning.

TELESCOPE CYLINDER HOLDING VALVE:

A holding valve is directly connected to the base of the primary telescope cylinder rod. The valve is to hold the boom in position should loss of power or pressure line failure occur.

The holding valve should be checked with the boom elevated to the maximum angle and the boom extended to a 5-foot (1.5 m) load radius. A 20,000-pound (9000 kg) load on a two-part line is required for this test. Use the hoist to lift this load about 6 inches (15 cm) above the ground.

The radius of the test load should be within the rating on the capacity chart. Use great care to prevent the load from hitting the crane.

Turn the engine off and pull the TELESCOPE lever to the RETRACT position. If the boom retracts, the valve should be adjusted. To adjust the holding valve, loosen the lock nut on the adjusting screw and tighten screw until unpowered movement stops. Retighten the lock nut to hold the proper adjustment.

ENGINE MAINTENANCE

AIR CLEANER SERVICE:

Clean out the dust cup every 50 hours. Loosen the clamps around the cup and housing and remove the cup. Dump dust out of cup. Clean gasket and sealing surfaces with a damp cloth. Replace cup gasket if it shows signs of damage. Replace cup with arrows pointing up and tighten clamp. Clean the intake cap screen every 50 hours, and perform a thorough inspection of the air intake pipes and joints.

Clean the filter element every 250 hours or every 3 months, whichever comes sooner and replace the element every 500 hours or 6 months. Remove and clean the dust cup and gasket, and the intake cap. Remove the wing nut on the element and gently remove the element. Bumping the element during removal may cause dirt to fall into the clean air tube. Clean the inside of the housing carefully with a damp cloth. To clean the element, use a compressed air blower nozzle with less than 100 PSI (690 kPa) and blow air from the inside of the element. Shake dust off of the outside of the element. Make sure the gaskets and element fit properly and reassemble, being careful not to allow any dust into the intake pipe.

Do not remove an element just for inspection. This may do more harm than good. You cannot judge the element condition by its appearance. If you think the filter may need service, remove it and replace or clean it before reassembling air cleaner. Conditions where more dirt than usual is in the air, especially soot, will make more frequent service necessary. If there is a significant amount of dust in the dust cup when it is cleaned every 50 hours, clean the element every 100 hours and replace it every 200 hours--or more frequently in extremely dusty conditions. Excessive exhaust smoke or loss of power may indicate a plugged filter.

COOLING SYSTEM:

Check the level of coolant in the radiator overflow tank daily. Add a mixture of antifreeze and distilled water to the overflow tank as required to maintain the coolant level. Check the radiator fins for dirt or debris daily and wash the fins with a pressure or steam cleaner every 50 hours, or as required. Check the antifreeze protection level every 500 hours. Every two years, flush the cooling system and replace the thermostat and coolant. Pressure test the system as specified by the engine manufacturer.

SPARE PARTS LIST:

A spare parts list (including oil filter, fuel filter, etc.) may be found in the Parts Manual, under Engine Installation.

MAJOR ENGINE SERVICING OR OVERHAUL:

Major servicing or overhaul is beyond the scope of this manual. Consult authorized engine service manual or rely on an authorized engine service center.

MECHANICAL ADJUSTMENTS

FASTENERS:

All fasteners on the IC-100 should be checked and retightened if required, as a part of the preventive maintenance program. Particular attention should be given to the drive axle mounting bolts, pump mounting bolts, pump drive shaft bolts, swing bearing bolts, swing gearbox bolts, winch bolts, and wheel nuts. All bolts used in assembly are heat-treated Grade 5 or better. Torque wheel nuts to 500 foot-pounds (680 Nm). As part of routine maintenance, inspect the swing bearing bolts as follows:

- Inner race, hex head bolts or nuts: 230-250 foot-pounds (310-340 Nm)
- Outer race, socket head cap screws or nuts: 250-270 foot-pounds (340-370 Nm)

Note the inspection torques are less than the installation torques. If any nuts or bolts rotate at less than the inspection torques, re-torque all swing bearing fasteners to the installation torques. See the turret sub-assembly and turret installation drawings in the parts manual for installation torques. The torque chart page 3-23 can be used on all other bolts.

SWING GEARBOX:

The swing gearbox assembly is attached to the chassis top plate by four cap-screws. It is held in proper engagement with the external teeth on the bull gear by two setscrews. It is further restrained from torsional movement by four bolts, two on each side of the gearbox mounting flange. The gearbox should be adjusted with the boom centered over front of the chassis. This centers the gearbox pinion on the "high side" of the bearing gear teeth. Adjust the gearbox inward until there is "light contact" between pinion and bull gear teeth. Retighten the four mounting bolts and the four side bolts.

REAR WHEEL BEARINGS:

Rear wheel bearings are adjusted with a light snug fit. Assure that hubs are free to rotate by hand after adjustment.

WHEEL TOE-IN SETTING:

Wheels are set for zero toe-in.

TRANSMISSION TROUBLESHOOTING AND OVERHAUL:

Procedures for transmission troubleshooting and overhaul are beyond the scope of the BMC Maintenance and Parts Manuals. The transmission factory service manual is available. Order BMC Part NO. 99000021.

PARK BRAKE TEST AND ADJUSTMENT:

Check tightness of parking brake lever daily while operating it. Perform the following test weekly and at the 50 hour maintenance interval:

1. Park the crane on level pavement.
2. While holding the foot brake pedal down, release the park brake lever and adjust the knob on the end of the lever until the park brake feels tight when applied.
3. Fully apply the parking brake.
4. Start the engine, retract the boom to the appropriate traveling position and raise the outriggers.
5. Select fourth gear.
6. Push down hard on the foot brake pedal.
7. Select forward gear.
8. Move the park brake lever fractionally downward, just over center, slightly releasing it. Hold park brake lever switch in the off position (located in the lever bracket).
9. Slowly release the foot brake pedal.
10. If the machine has not moved, use maximum engine speed. The machine should not move.
11. Do not do this test for longer than 30 seconds.
12. Reduce engine speed to an idle.
13. Return the park brake lever to the fully on position from its partially applied position. Place transmission in neutral.
14. If the machine moved during the test, set the crane on outriggers and adjust the clearance between the park brake pad and brake disc, and repeat the test. Maximum clearance is .010" (.25 mm) with park brake lever in the OFF position.



MAINTENANCE INFORMATION FOR OPTIONAL FOUR-WHEEL DRIVE:

The steering system pressure is set for 2500 psi with the optional four-wheel drive. This is set at the factory and should not need adjustment.

Additional grease zerks are provided on the drive shaft powering the rear wheels. Grease these zerks on the same schedule as those for the front drive shaft.

Check lubrication levels of the rear axle differential on the same 50 hour interval as the front axle differential. Replace lubricant on the same 12 month or 1000 hour interval as the front axle.

TORQUE DATA

BOLT GRADE	SAE GRADE 1 OR 2	SAE GRADE 5	SAE GRADE 8
MARKING			
MATERIAL	LOW CARBON	MEDIUM CARBON STEEL Q & T	MEDIUM CARBON ALLOY STEEL Q & T
MINIMUM TENSILE STRENGTH	64,000 PSI (441 MPa)	120,000 PSI (827 MPa)	150,000 PSI (1034 MPa)
BOLT SIZE	RECOMMENDED TORQUE VALUES FT-LBS (N-m)		
1/4	5 (7)	7 (10)	10.5 (14)
5/16	9 (12)	14 (19)	22 (30)
3/8	15 (20)	25 (34)	37 (50)
7/16	24 (32)	40 (54)	60 (81)
1/2	37 (50)	60 (81)	92 (125)
9/16	53 (72)	88 (119)	132 (179)
5/8	74 (100)	120 (163)	180 (244)
3/4	120 (163)	200 (271)	296 (401)
7/8	190 (258)	302 (409)	473 (641)
1	282 (382)	466 (632)	714 (968)



THE FOLLOWING RULES APPLY TO THE CHART:

1. Consult manufacturers' specific recommendations when available.
2. The chart may be used with coarse and fine thread fasteners lightly lubricated.
3. Increase torque by 20% when multiple tooth (shakeproof) lockwashers are used.
4. The torque values are given in foot-pounds (N·m).
5. Inch-pounds equivalent may be obtained by multiplying by 12.

IC-100-3A, GAS

TO ENGINE AND TRANSMISSION

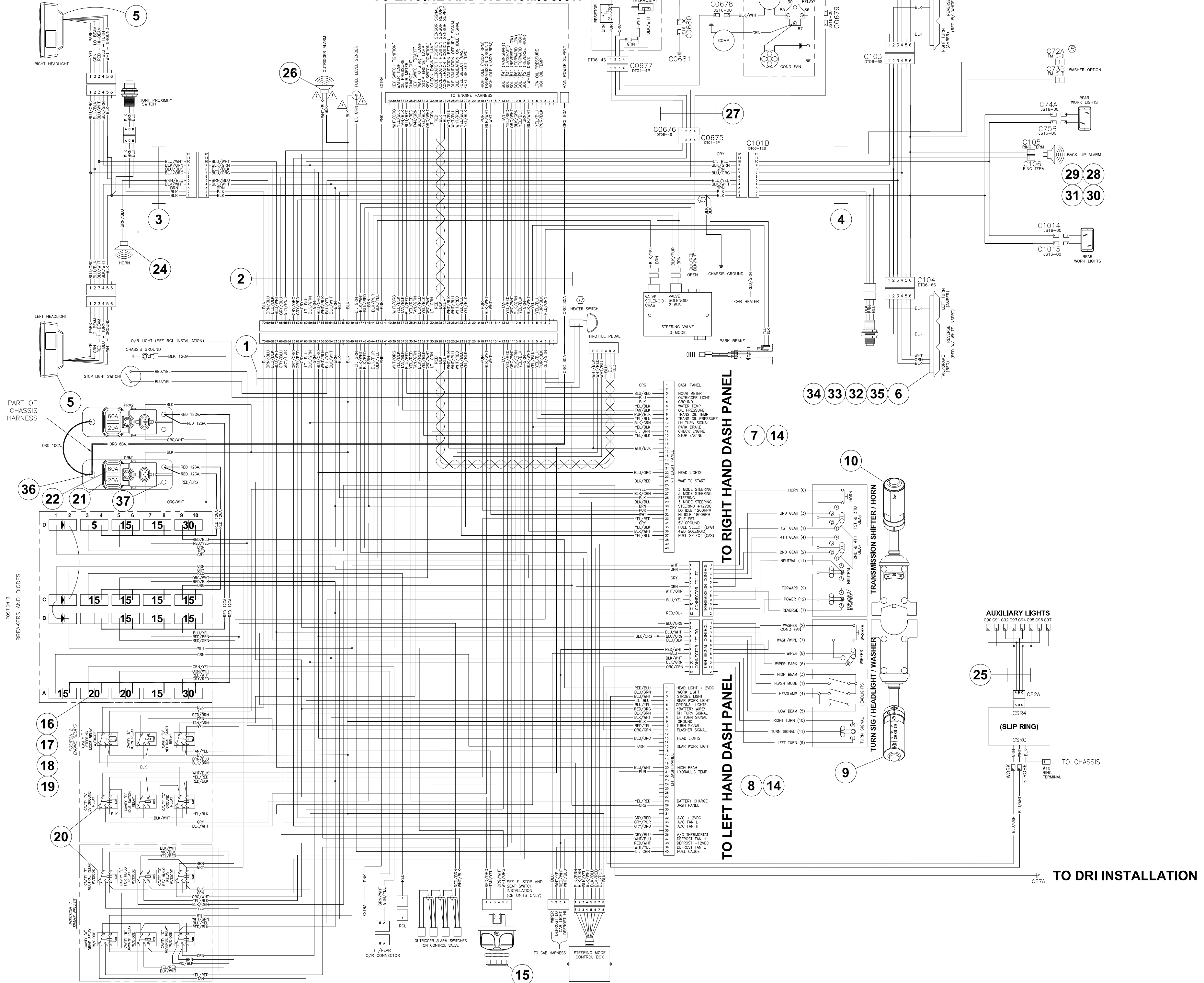

POSITION 3
BREAKERS AND DIODES

POSITION 1
TERMS RELAYS

POSITION 2
ENGINE RELAYS

TO RIGHT HAND DASH PANEL

TO LEFT HAND DASH PANEL

TO DRI INSTALLATION

AUXILIARY LIGHTS
C90 C91 C92 C93 C94 C95 C96 C97

(SLIP RING)
CSRC

CSR4

C82A

C67A

TO CHASSIS

#10 RING TERMINAL

BLU/GRN

BLU/WHI

STORAGE

WORK

BLU/WHI

BLU/WHI

BLU/WHI

BLU/WHI

BLU/WHI

BLU/WHI

